

1-1

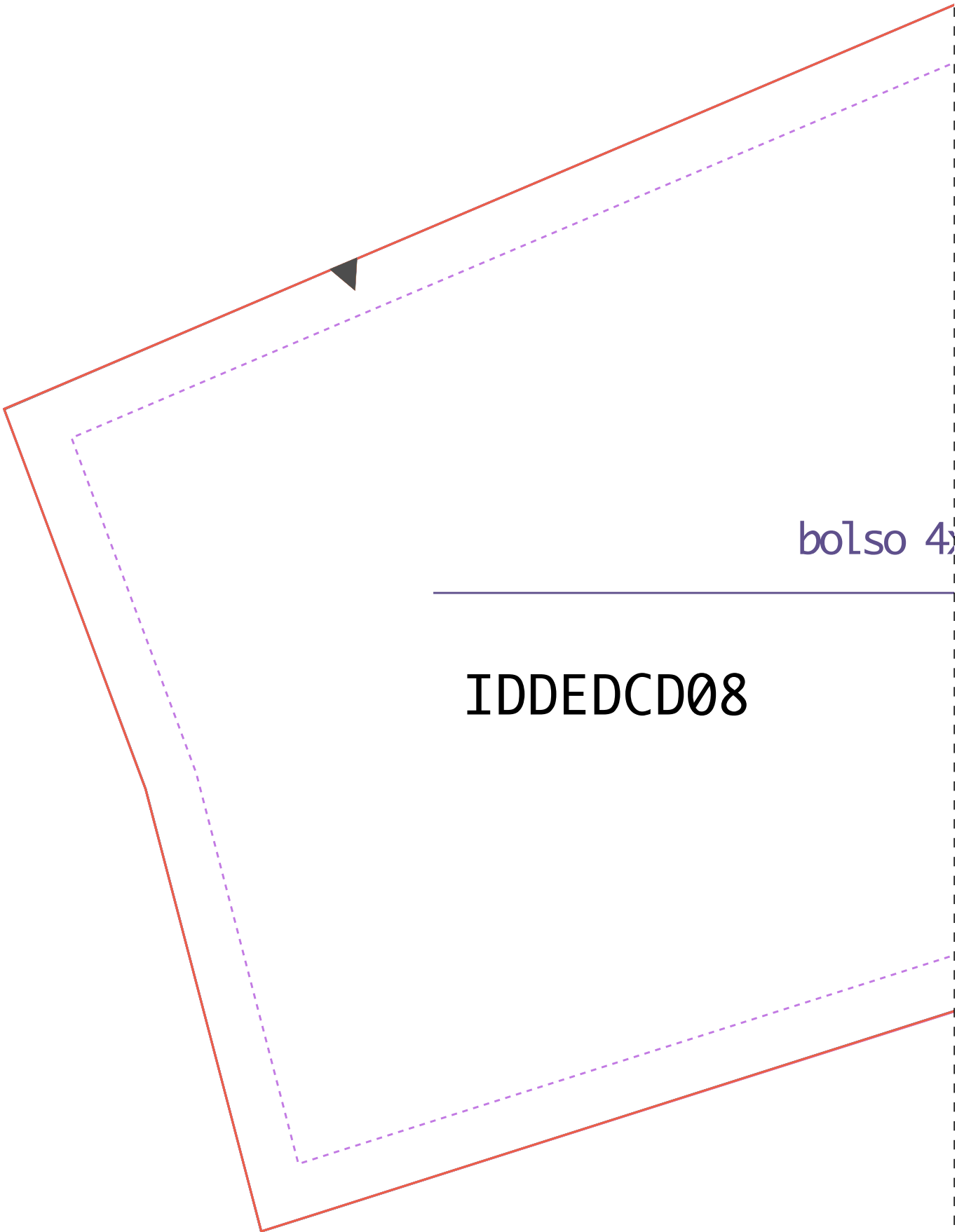

bolso 4)

IDDED CD08

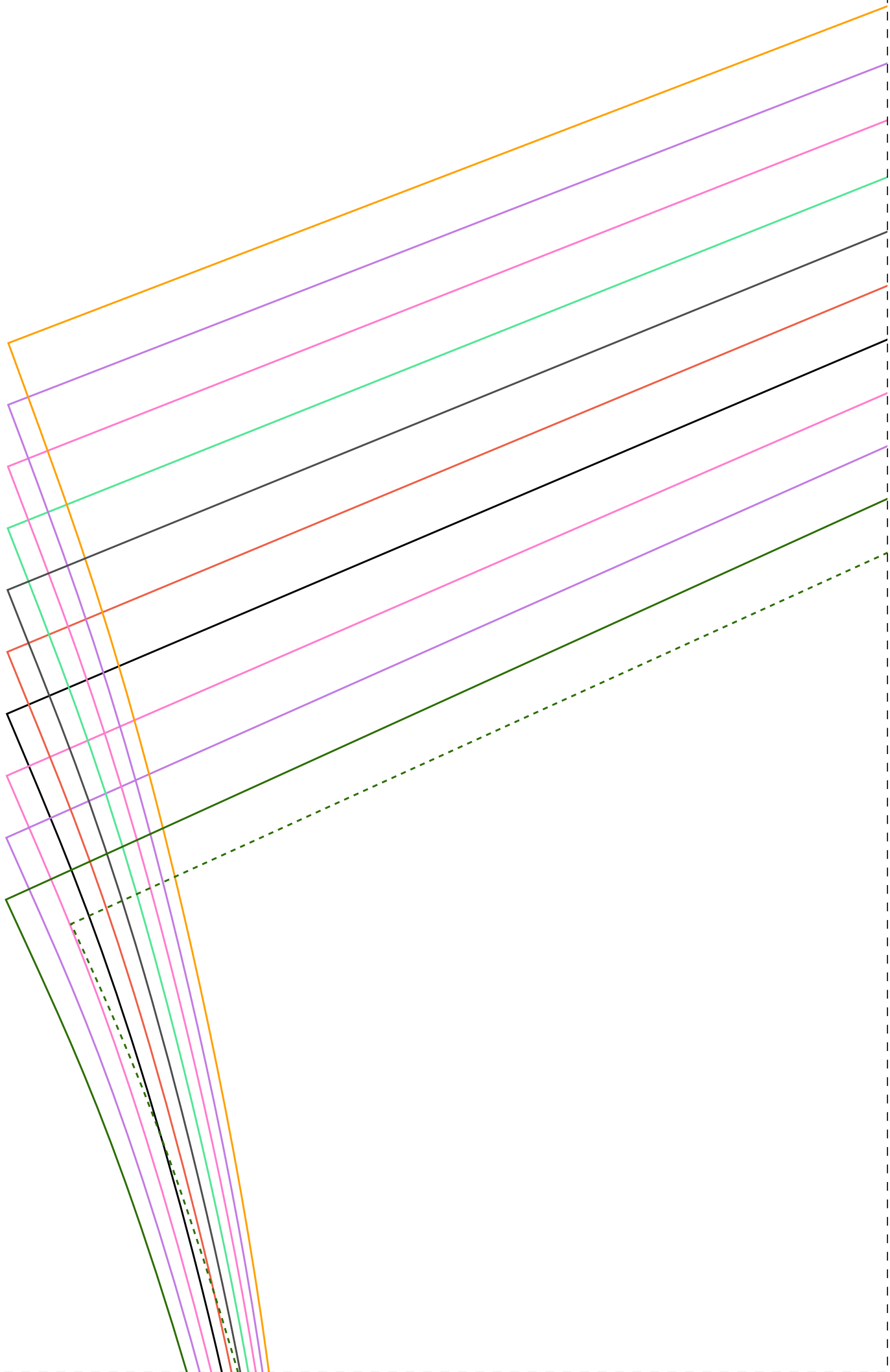

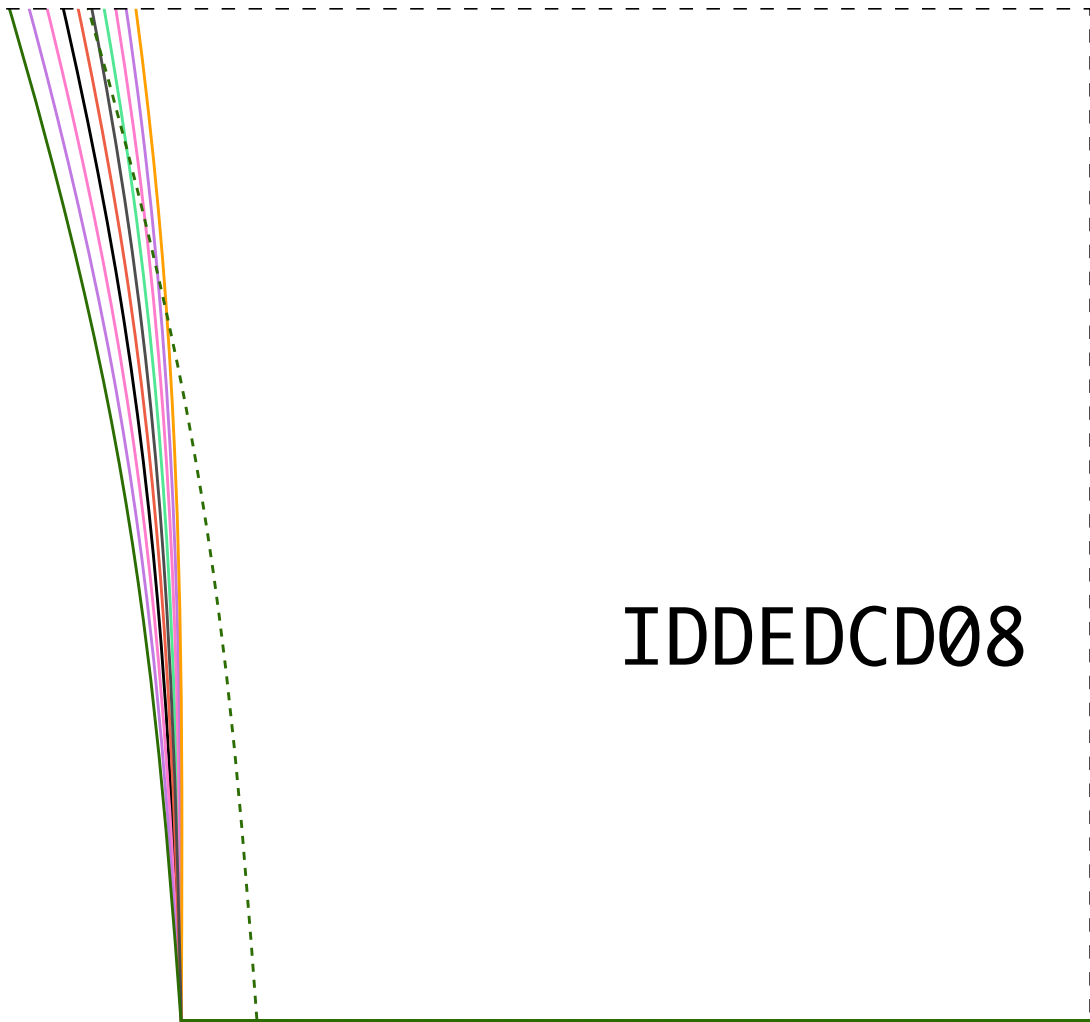

IDDED CD08

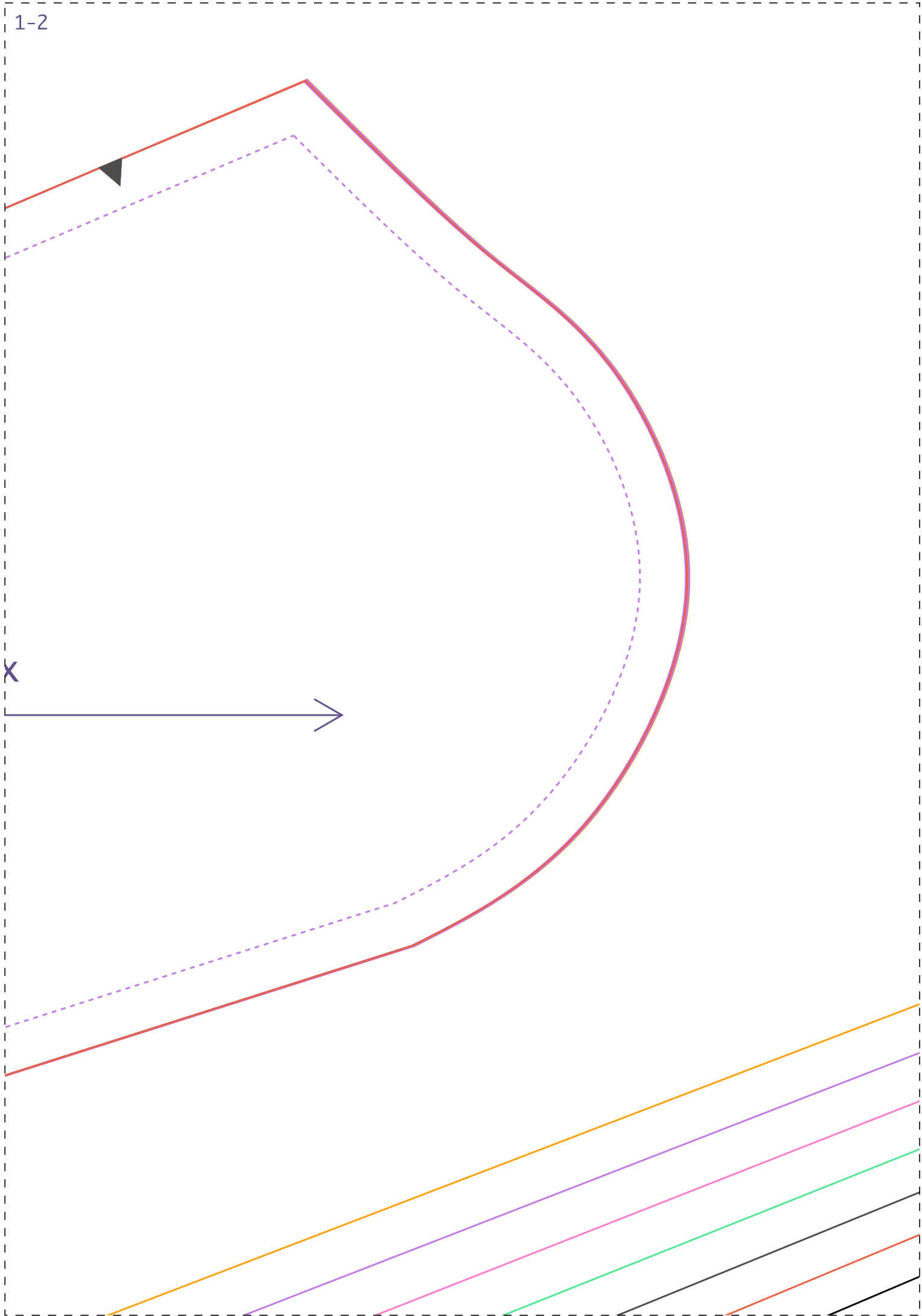

2-2

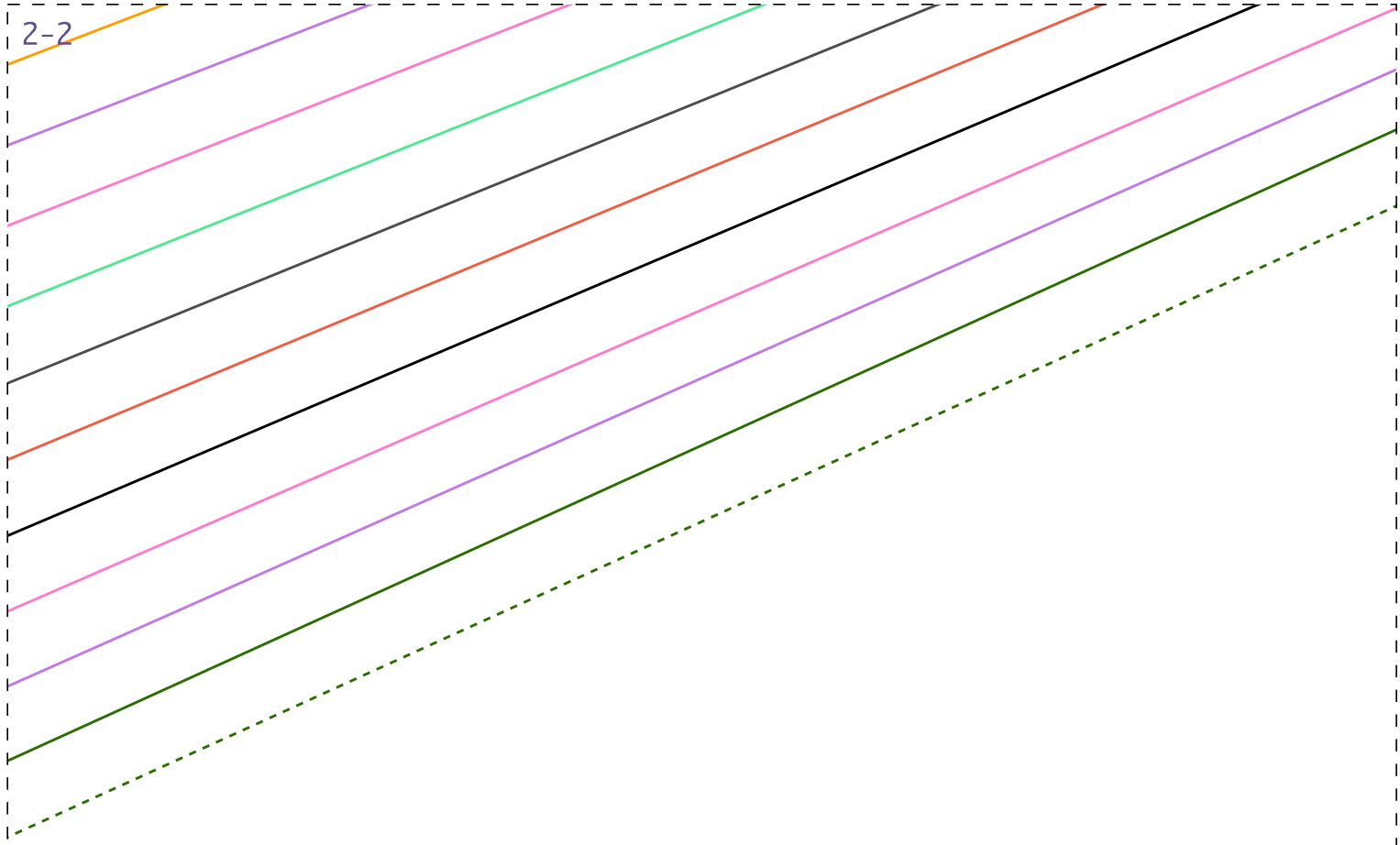



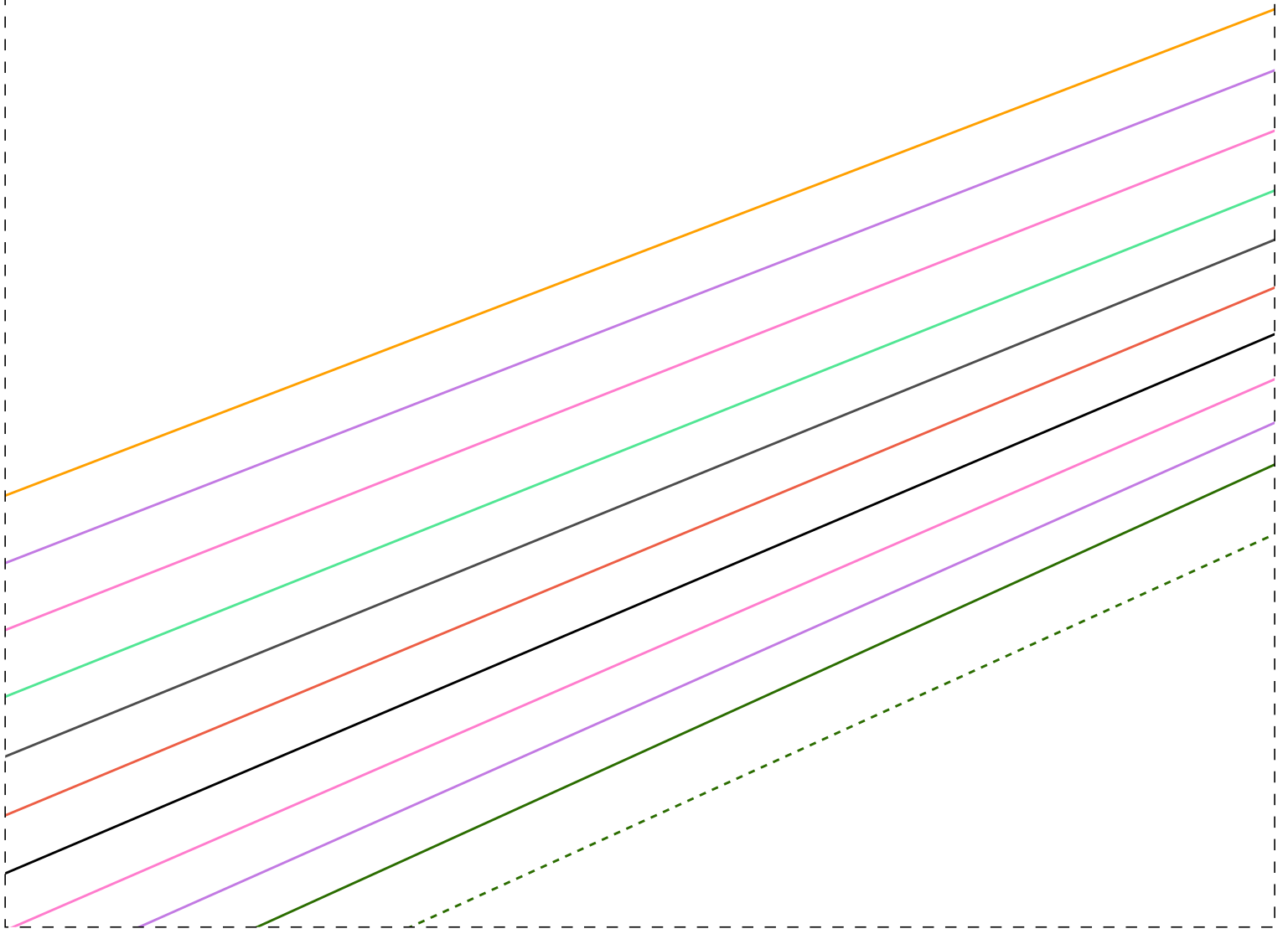

2-3

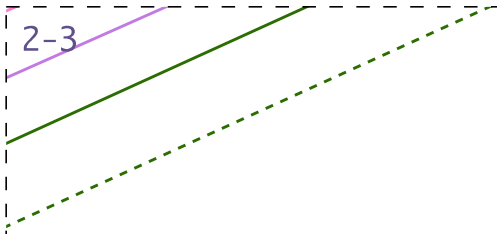

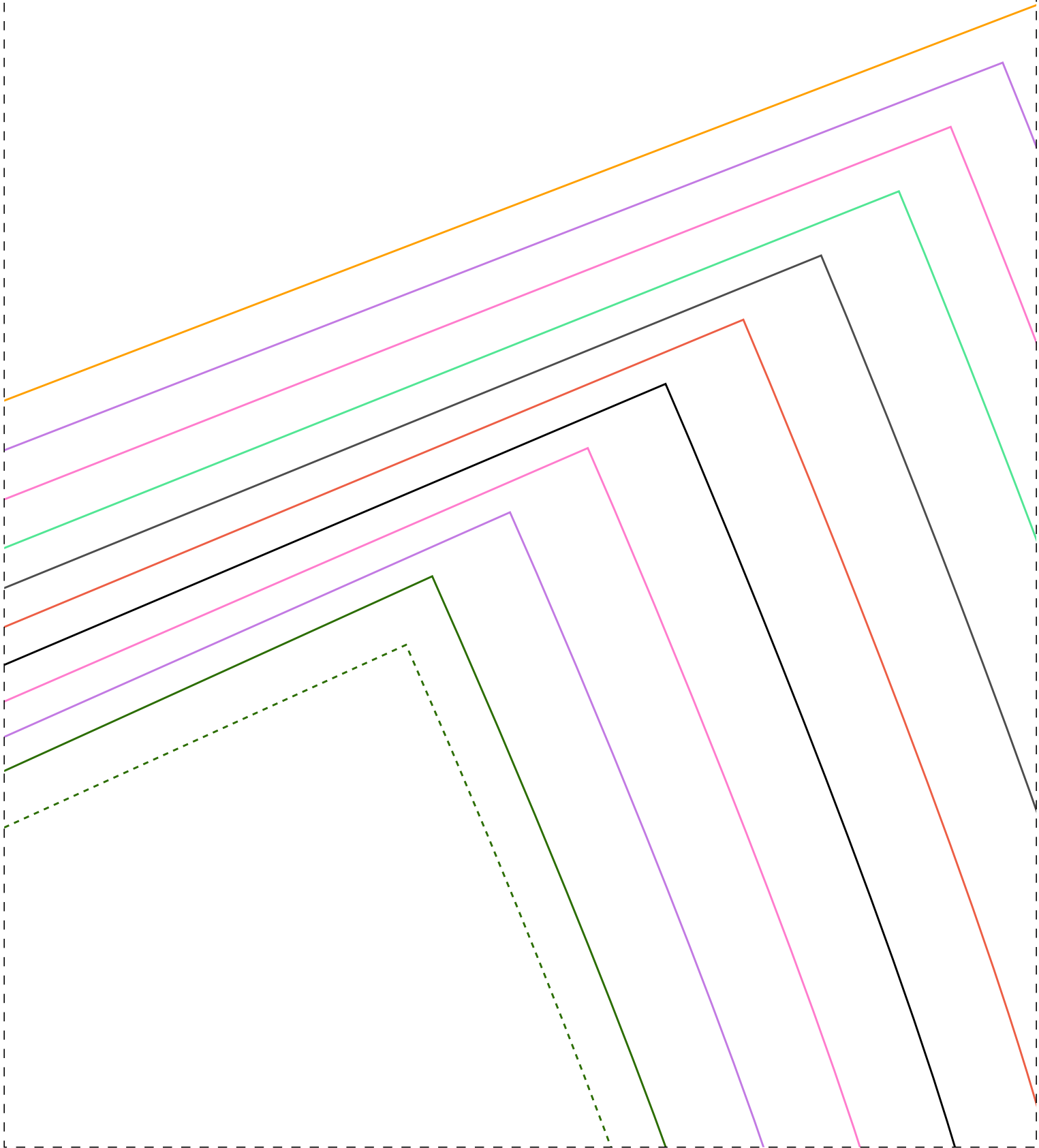

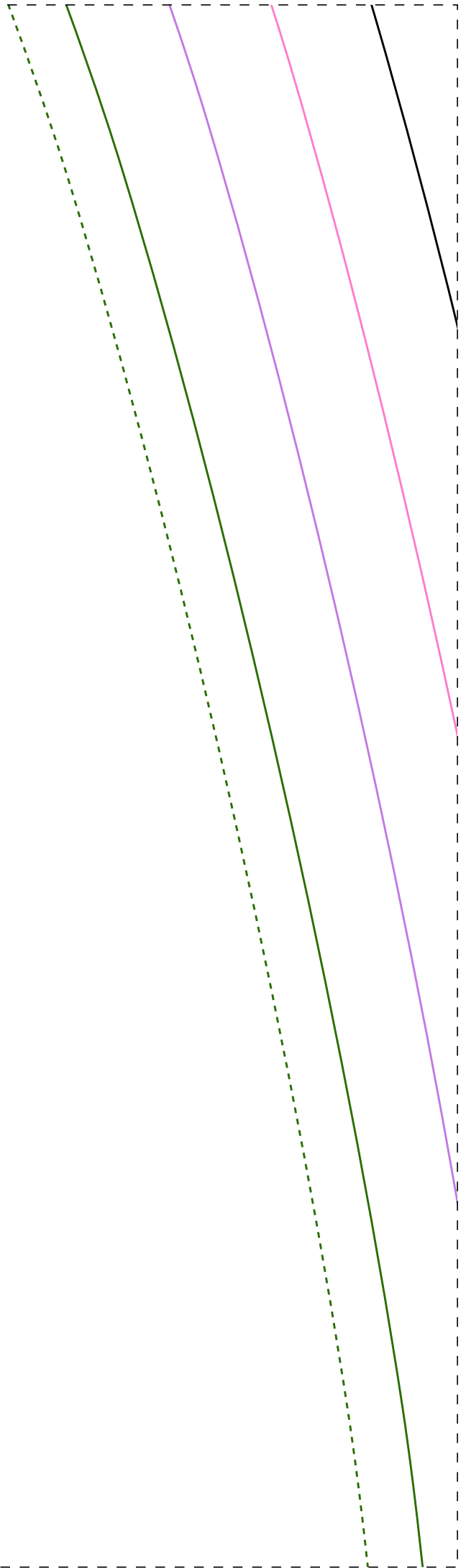

FICHA TÉCNICA:

- Tecido Plano 1,4m largura
- Viscose, viscolinho, linho, crepes, gabardine, ou similares
- Fechamento frontal com botões
- 2,80m para os tamanhos 36 ao 44
- 3,30m para os tamanhos 46 ao 54
- Botões
- Cortar elástico para a cintura:
36-62cm/38-64cm/40-66cm/42-70cm
44-74cm/46-78cm/48-82cm/50-86cm
20-90cm/54-94cm

1-5

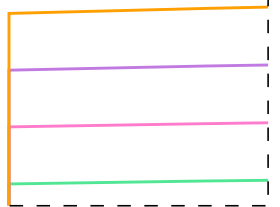
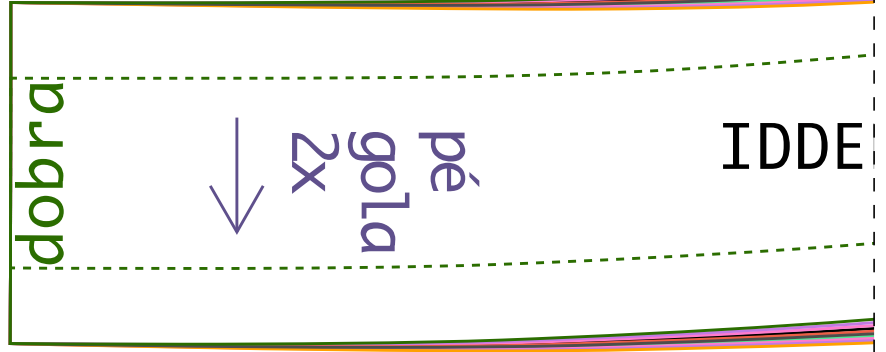
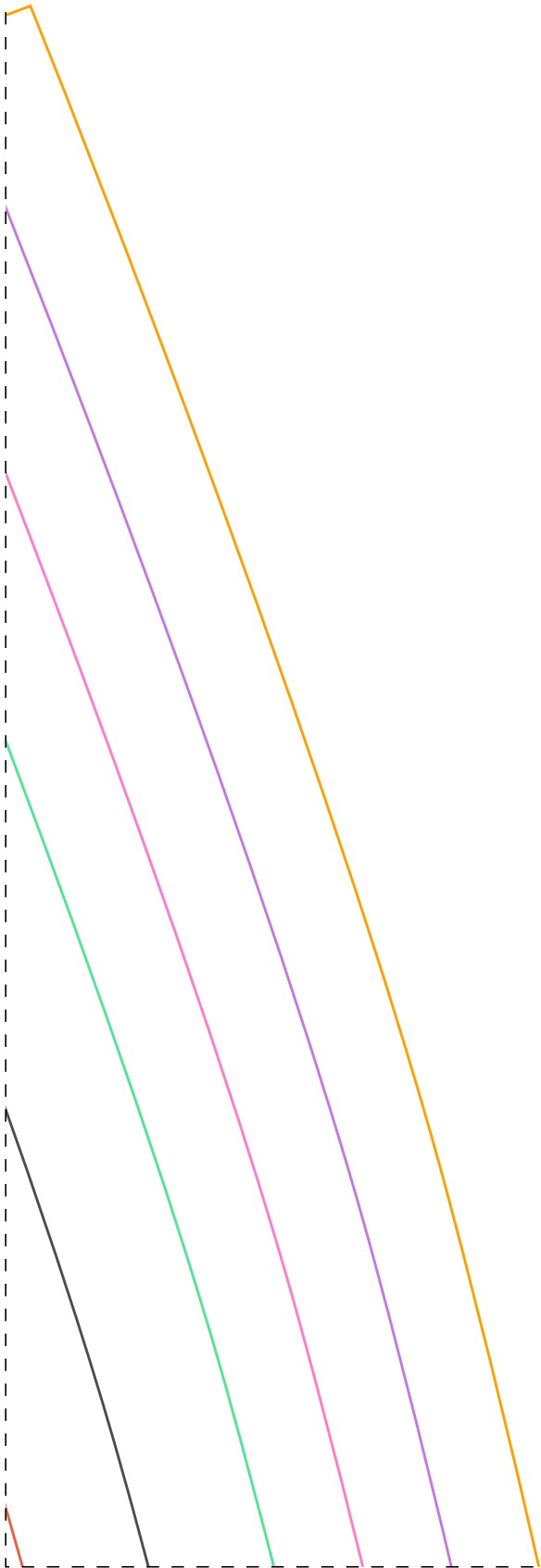

IDD EDCD 08

2-5

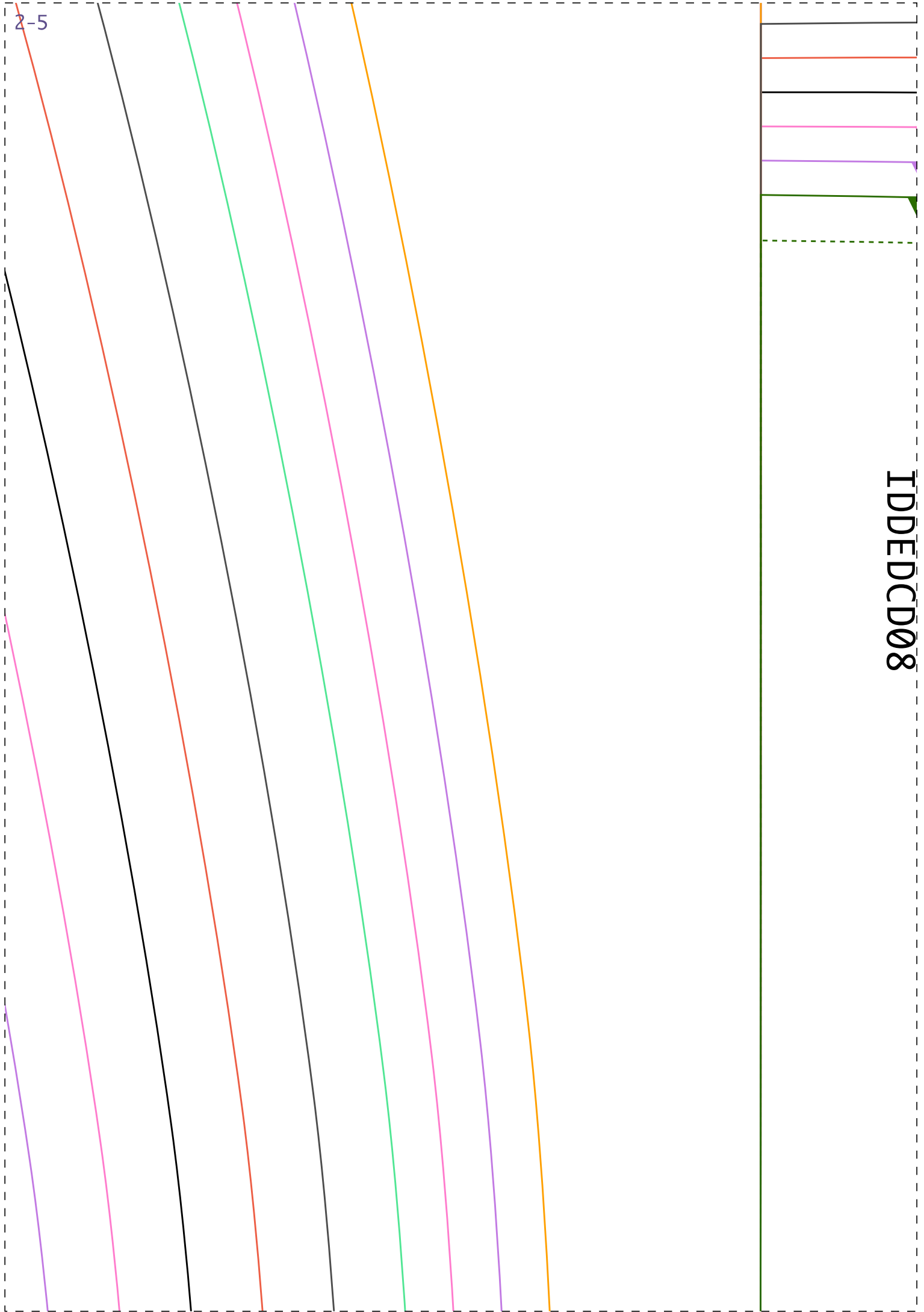

3-5

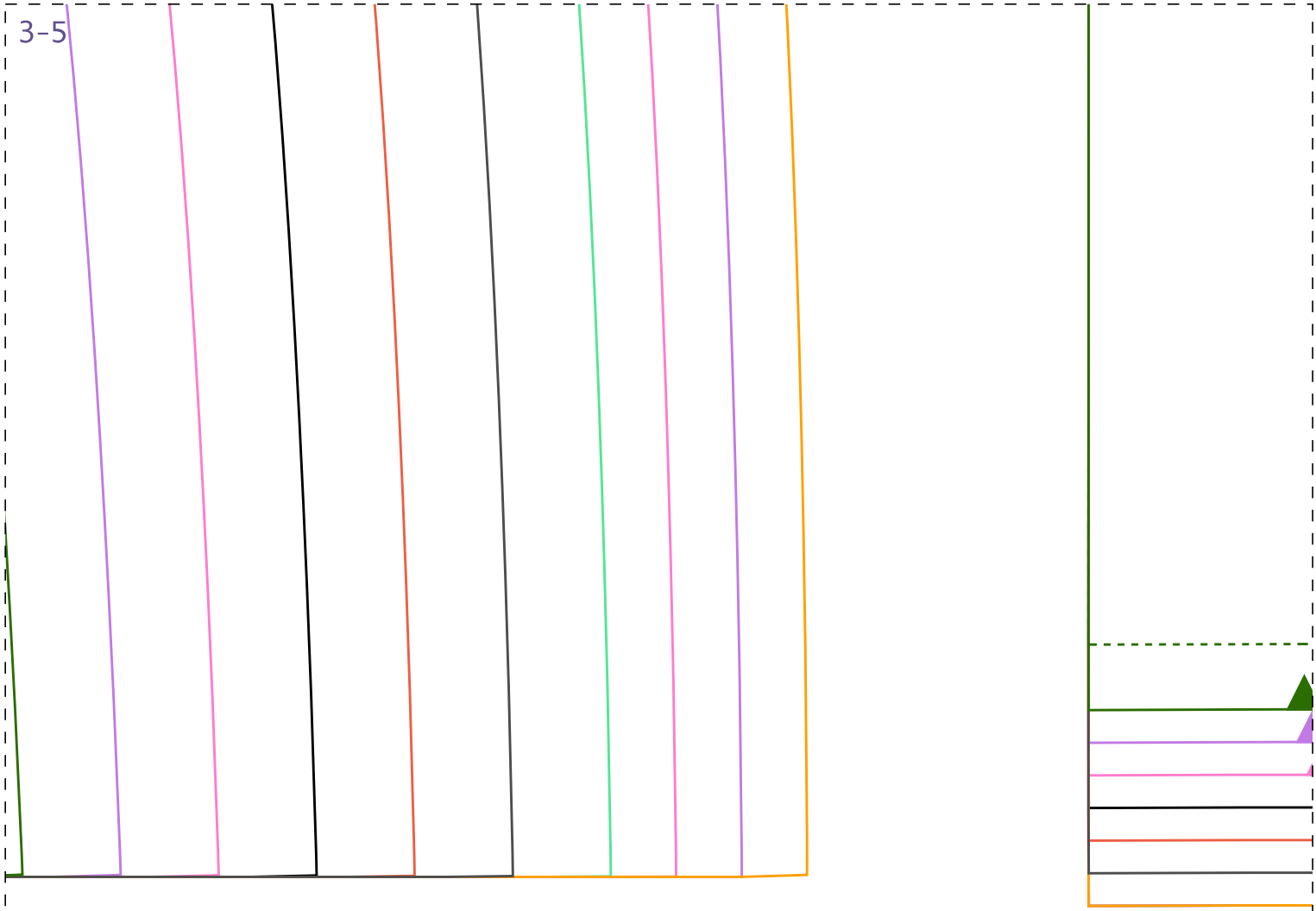

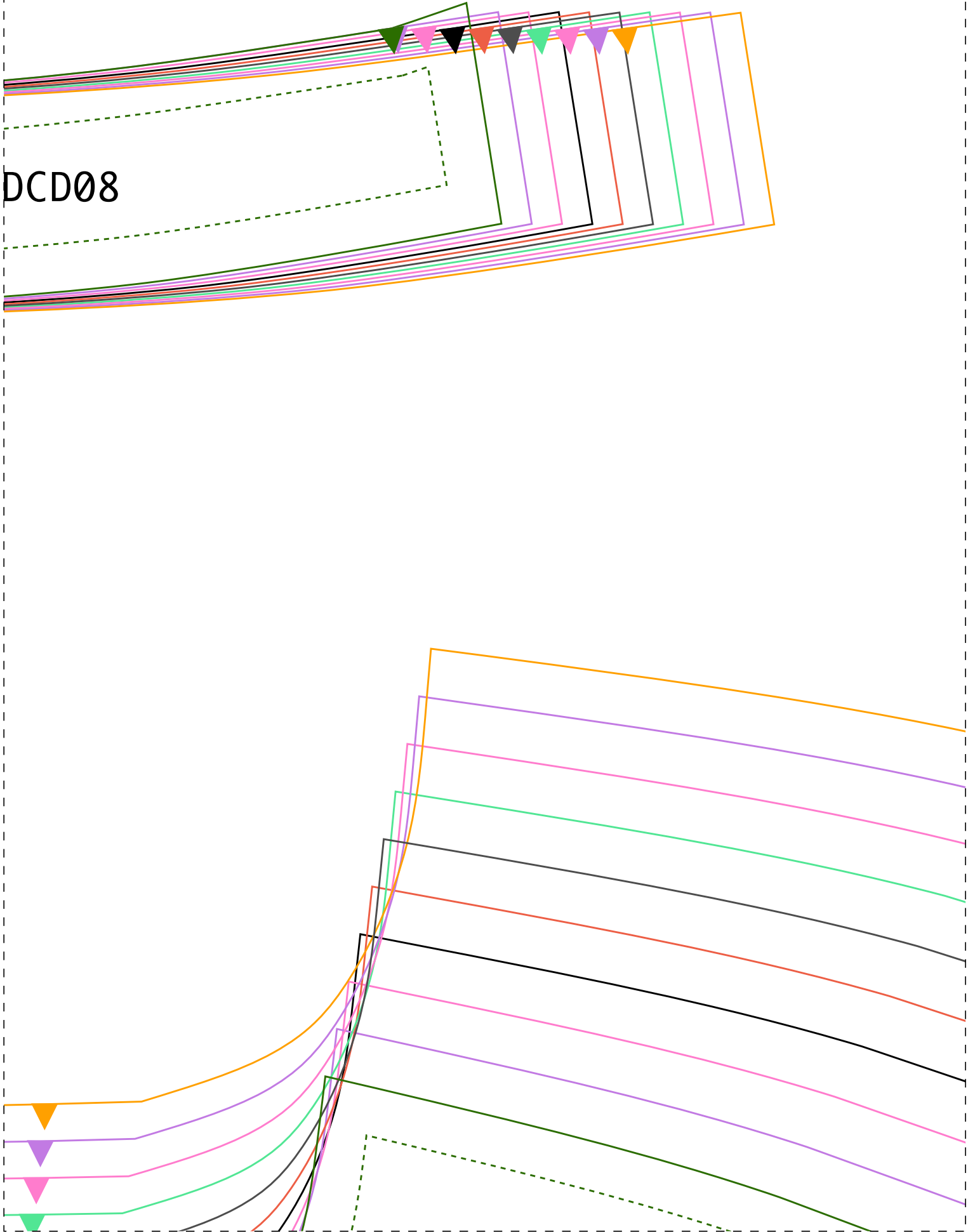

Instituto Diana Demarchi
Escola de Costurar
Vestido Manga Japonesa e Botõ
PROIBIDA REVENDA

frente 2x

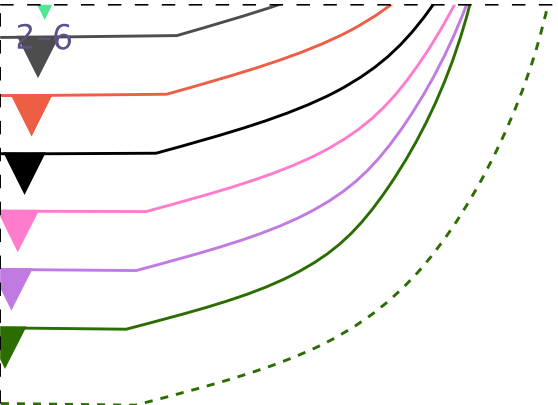

3-6

es

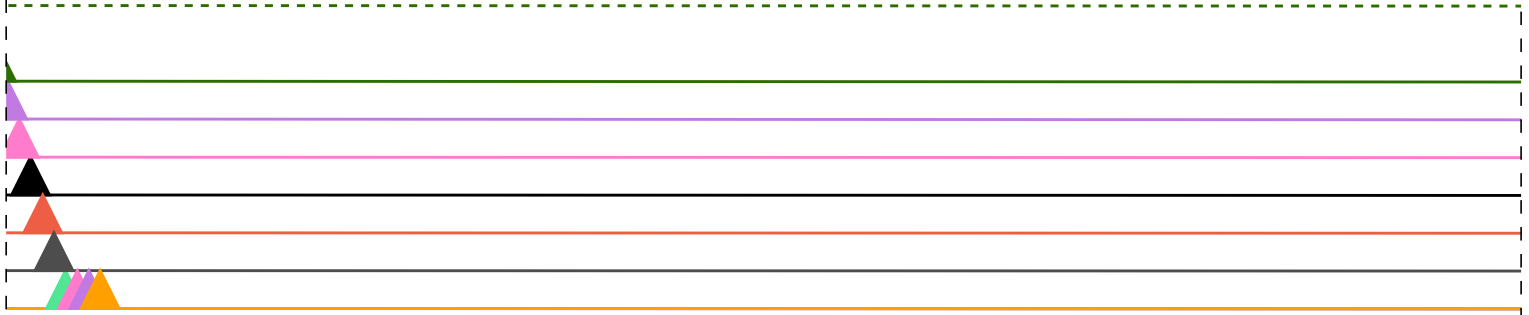

Teste de imp
mólde, meça,
a mesma medi
você se cert
impresso no

40

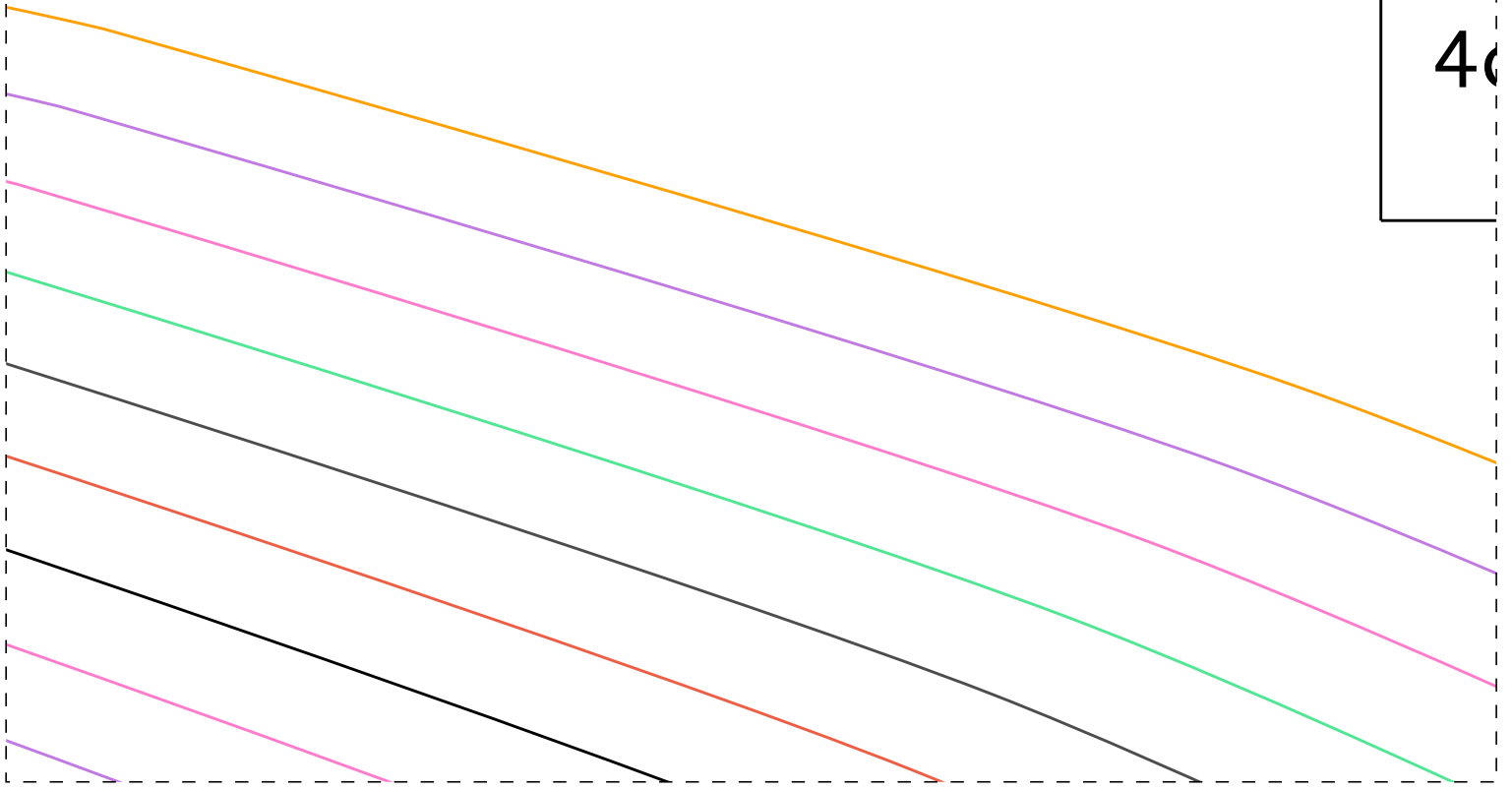

2-7

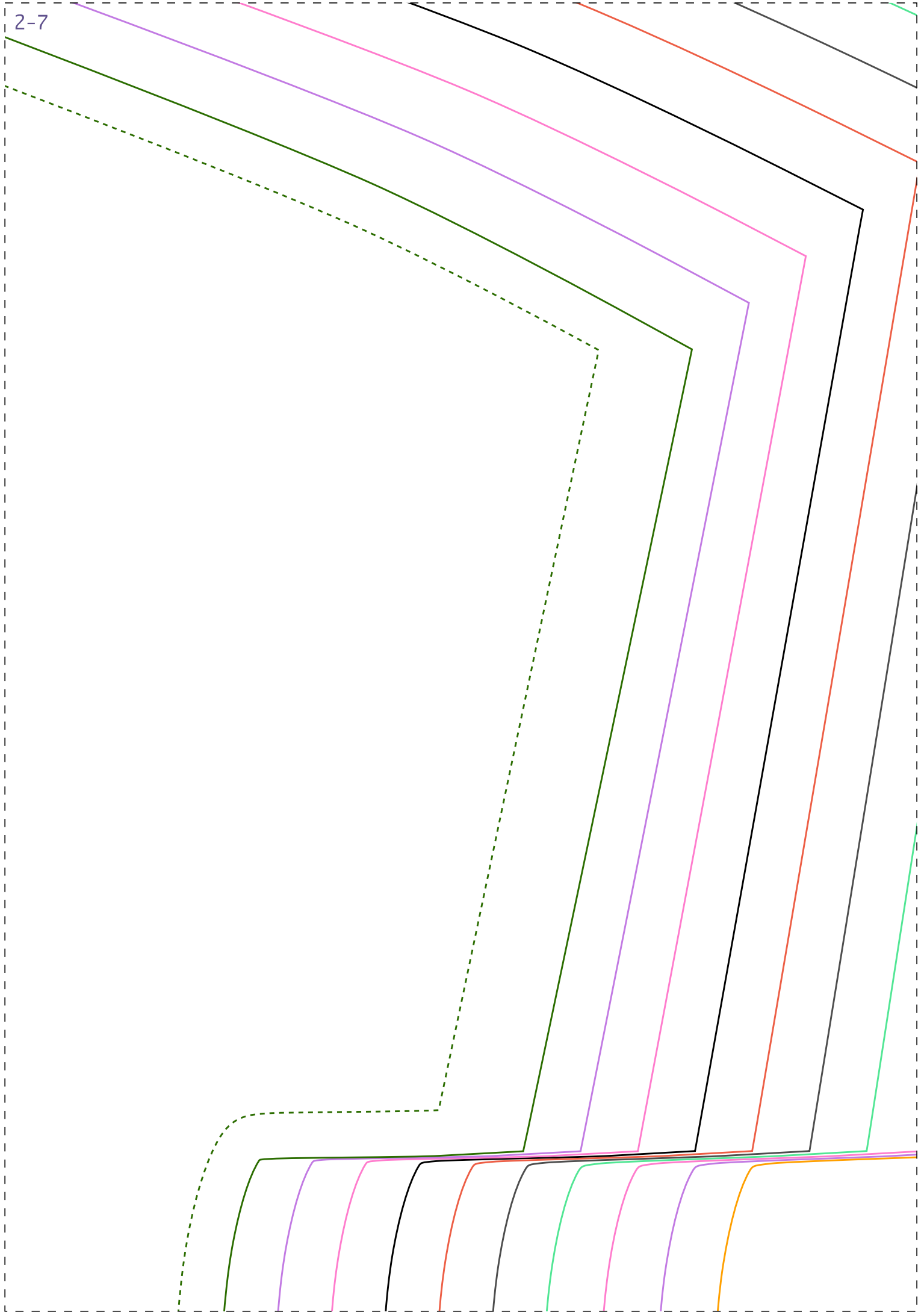

3-7

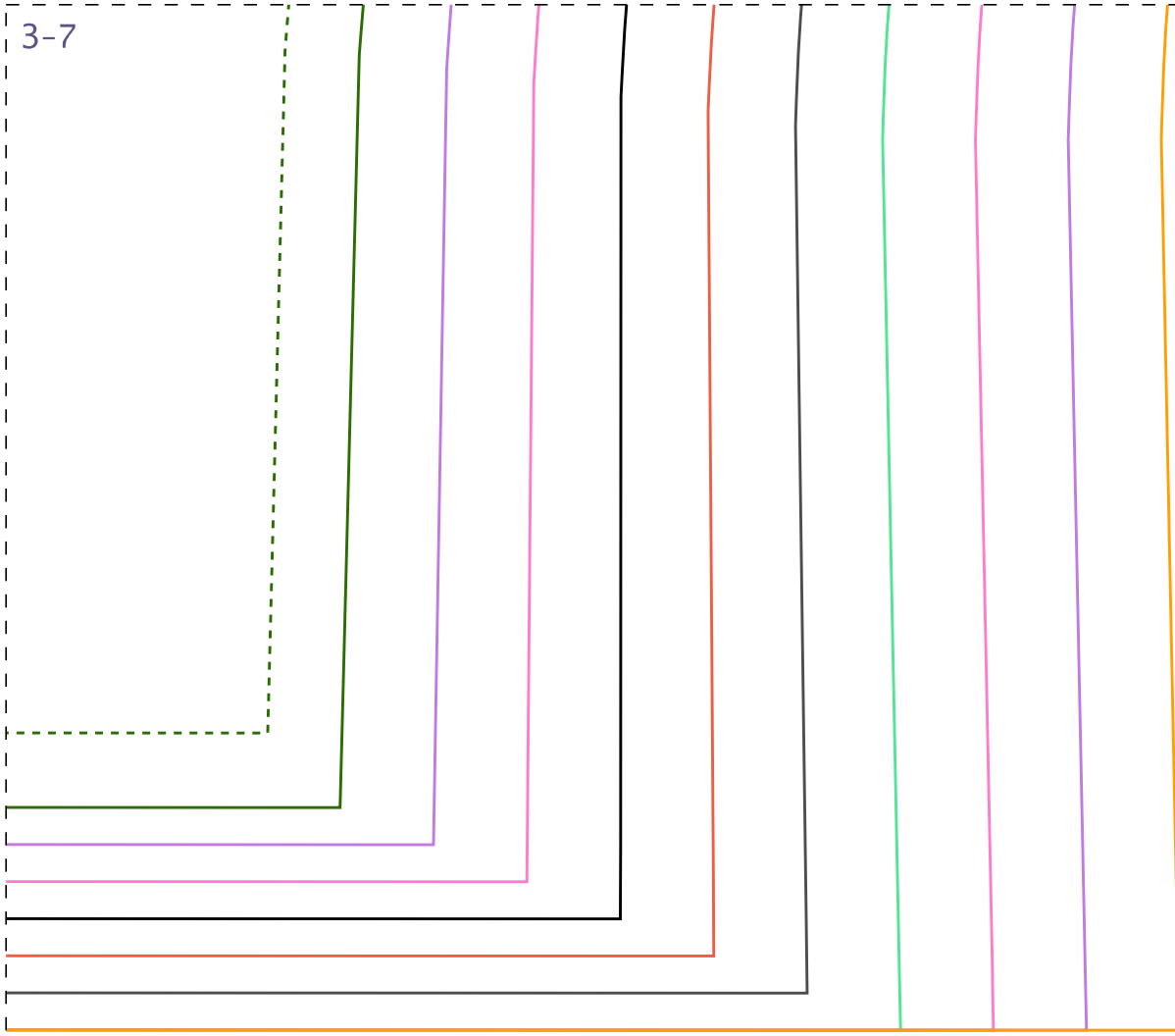

pressão: ao imprimir seu
o quadrado que deverá ter
da informada (4cm), assim
ificará que ele foi
tamanho correto.

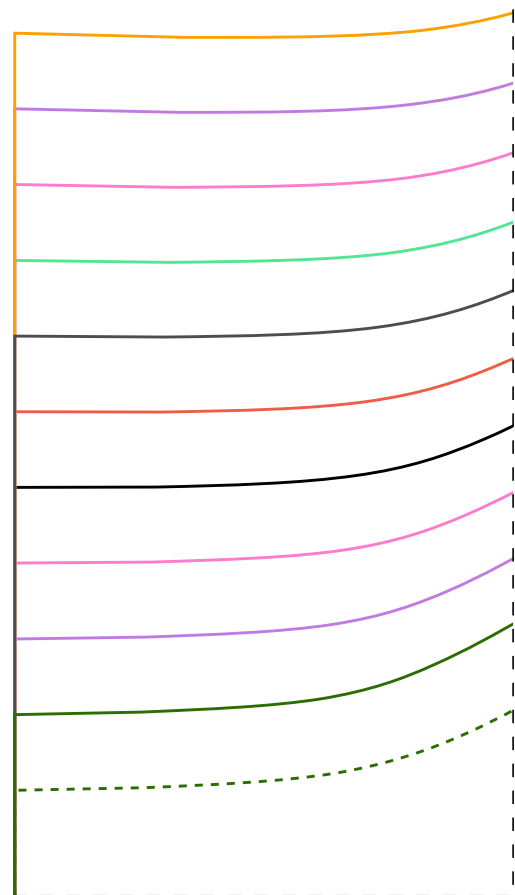
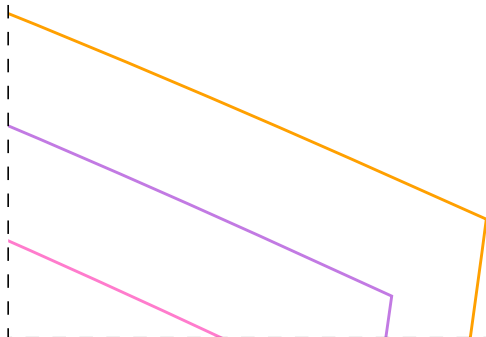
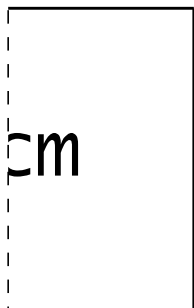

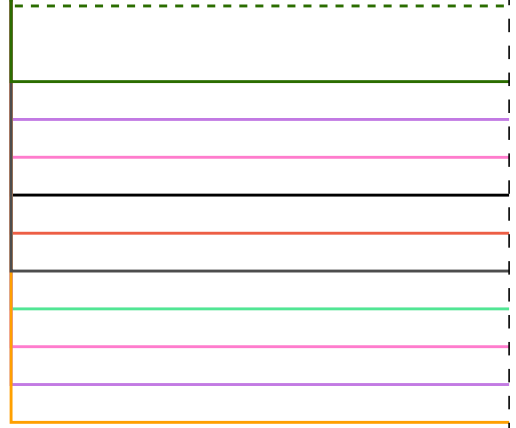

1-9

dobra

IDDEDCCD08

gola 2x

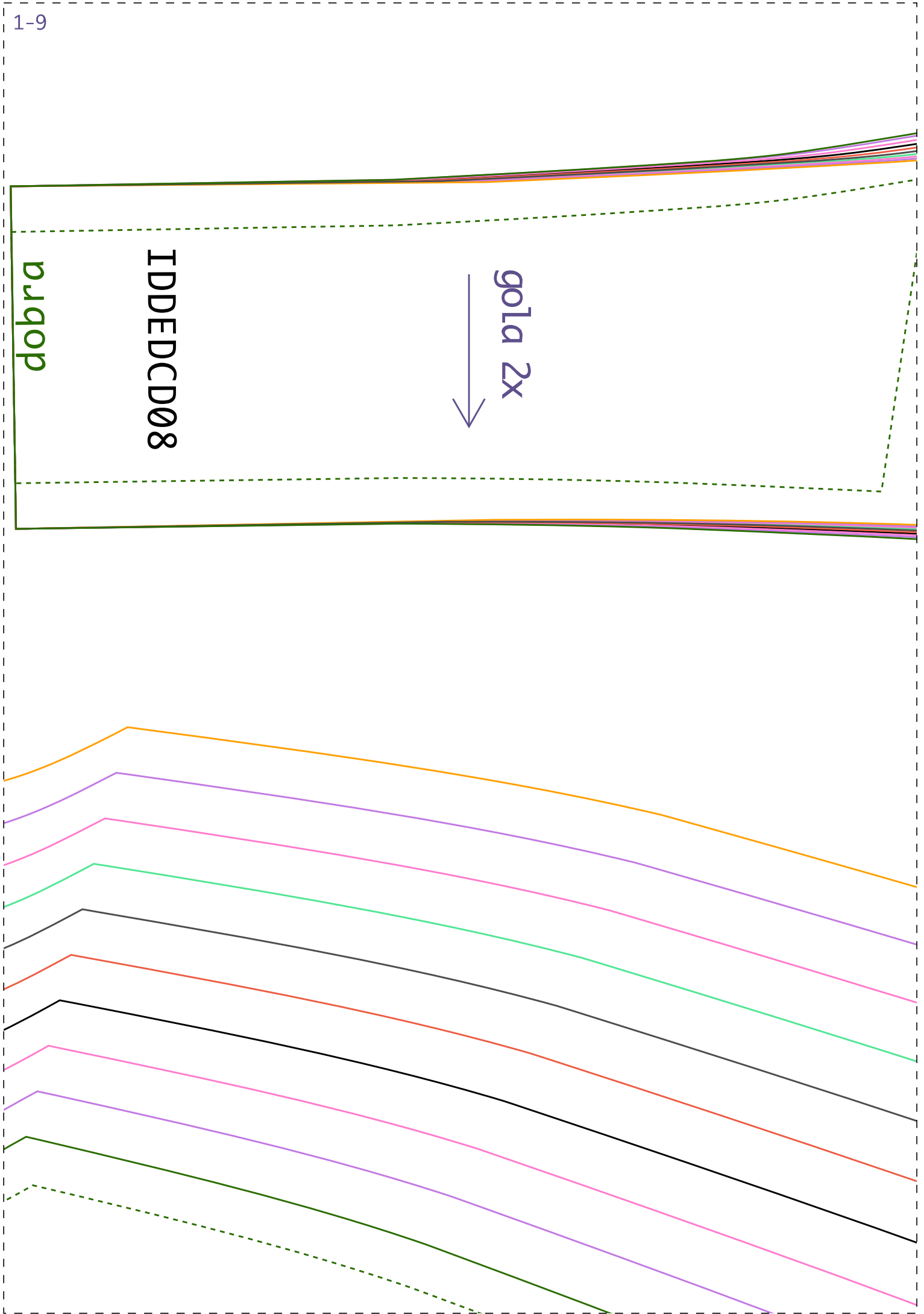

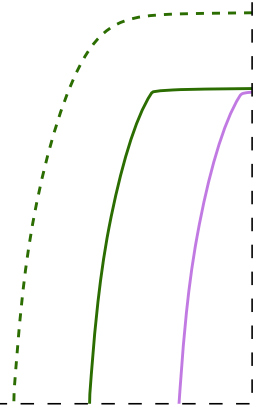
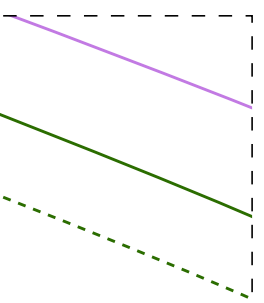

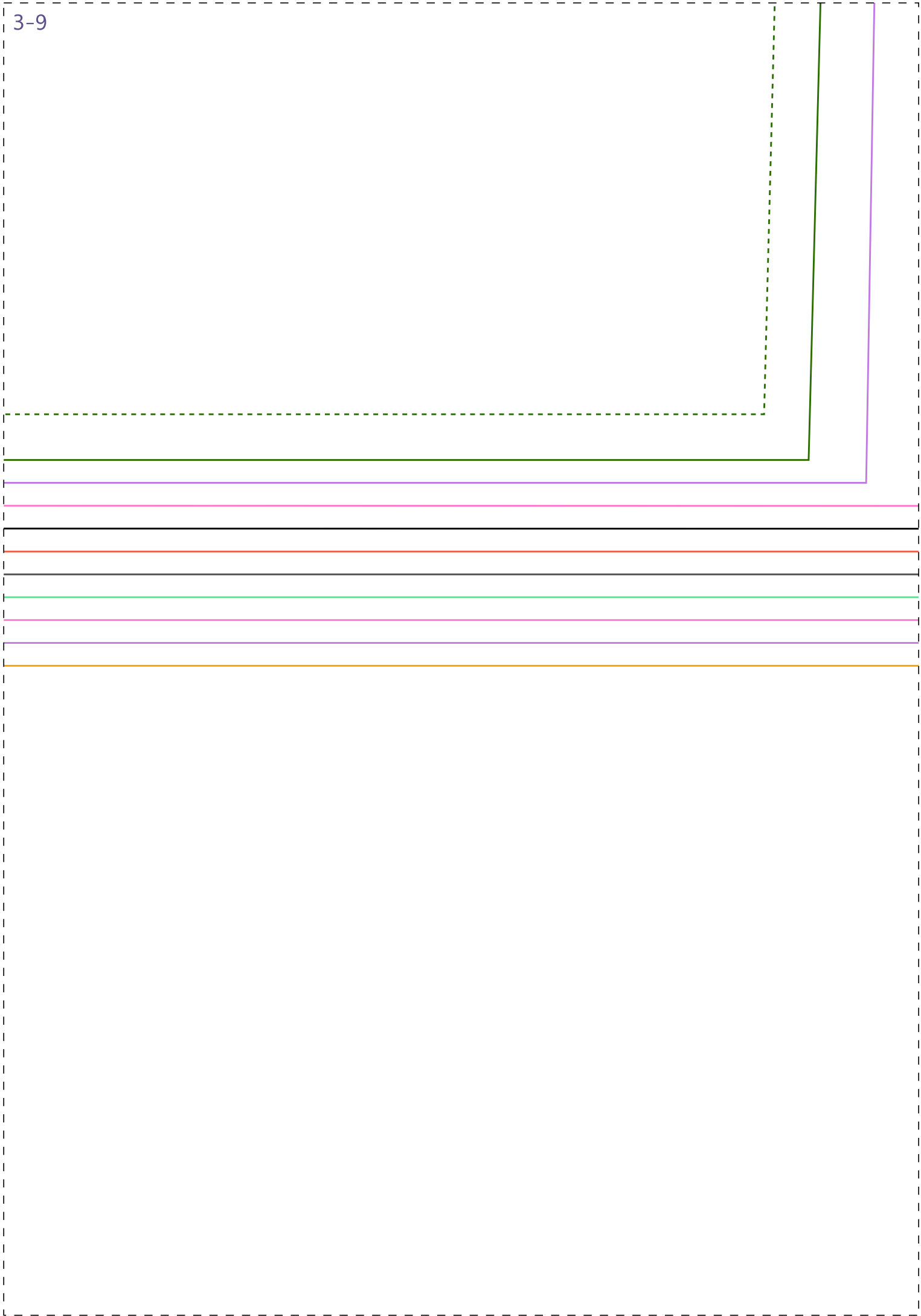

1-10

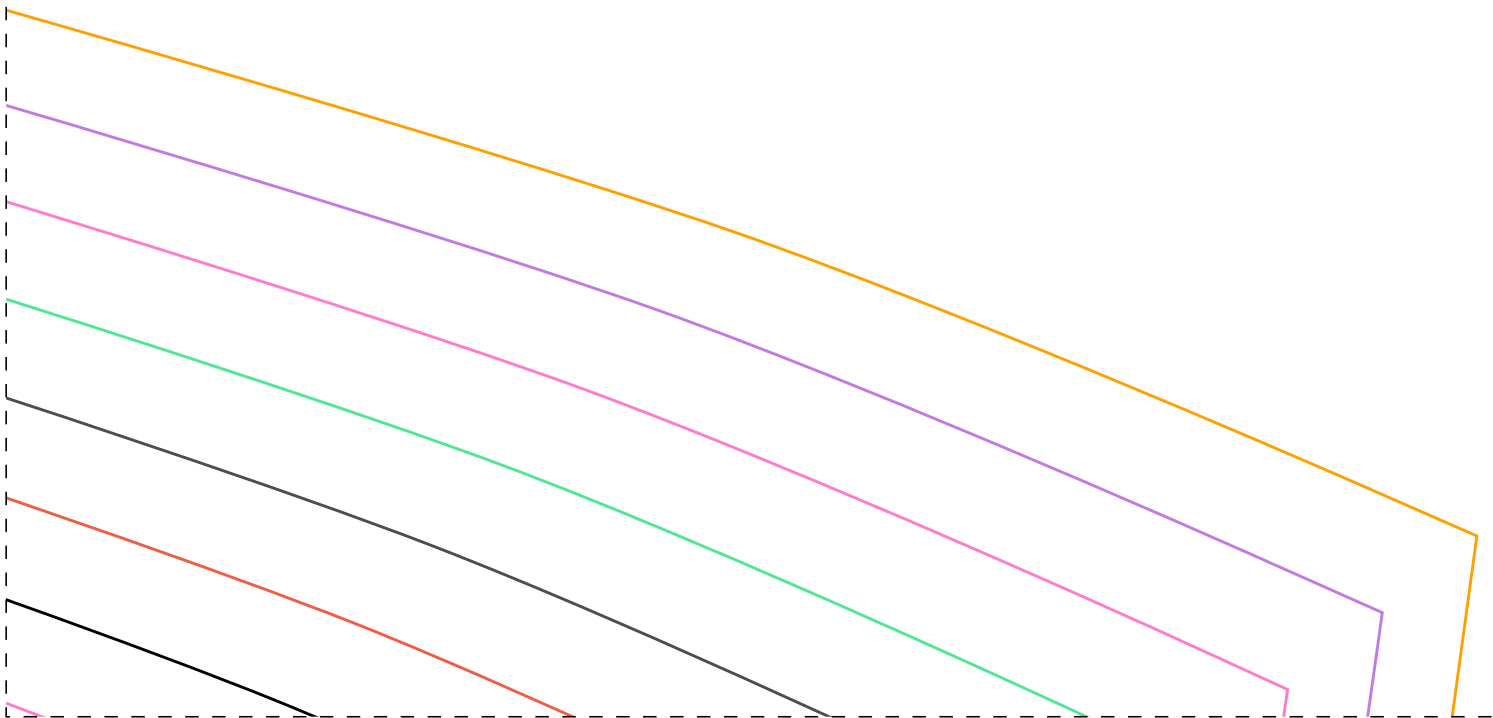
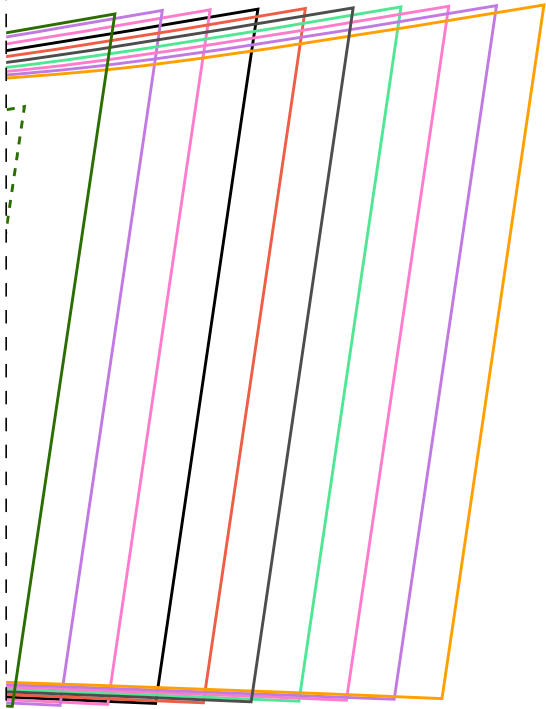

2-10

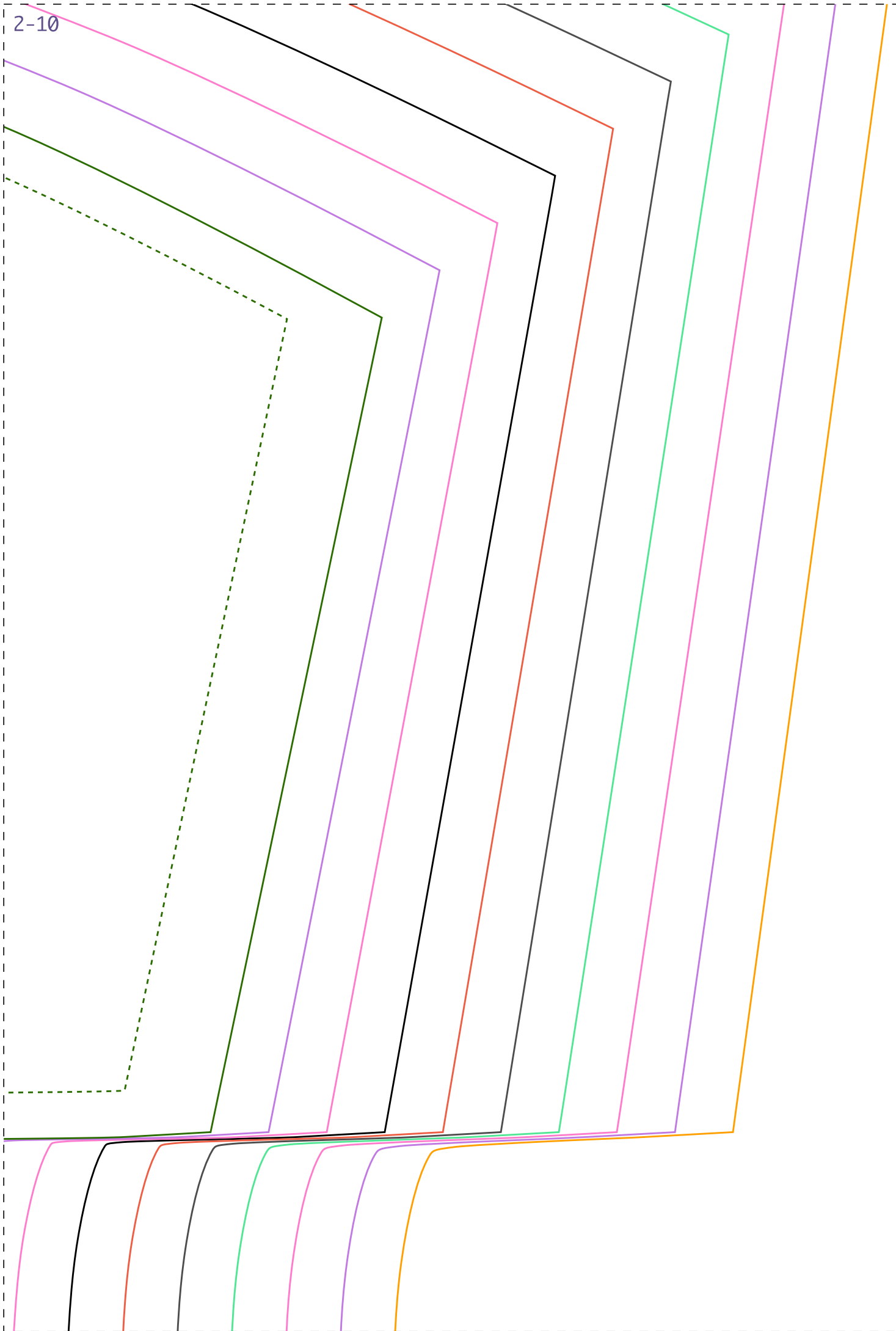

3-10

