

Dobra

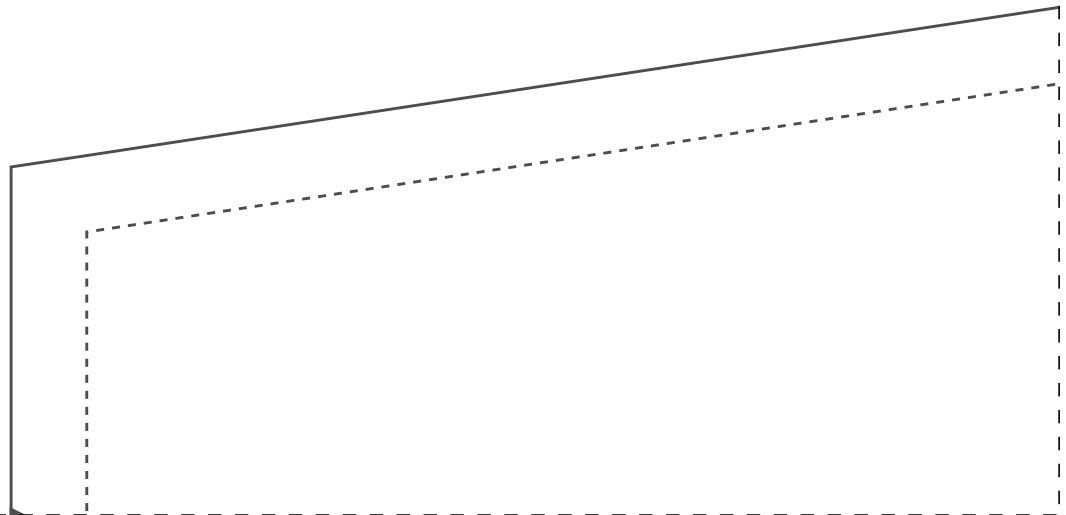

Instituto Diana Demarchi
Vestido com Regulagem nas
Costas E Bolso Externo

PROIBIDA REVENDA

bolso 2x
46

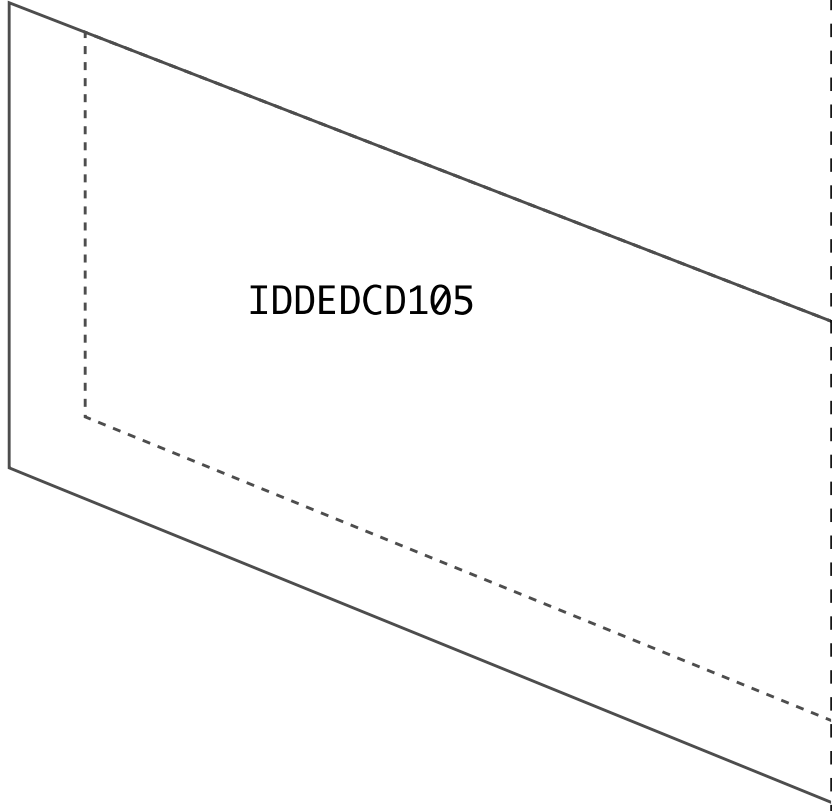

1-2

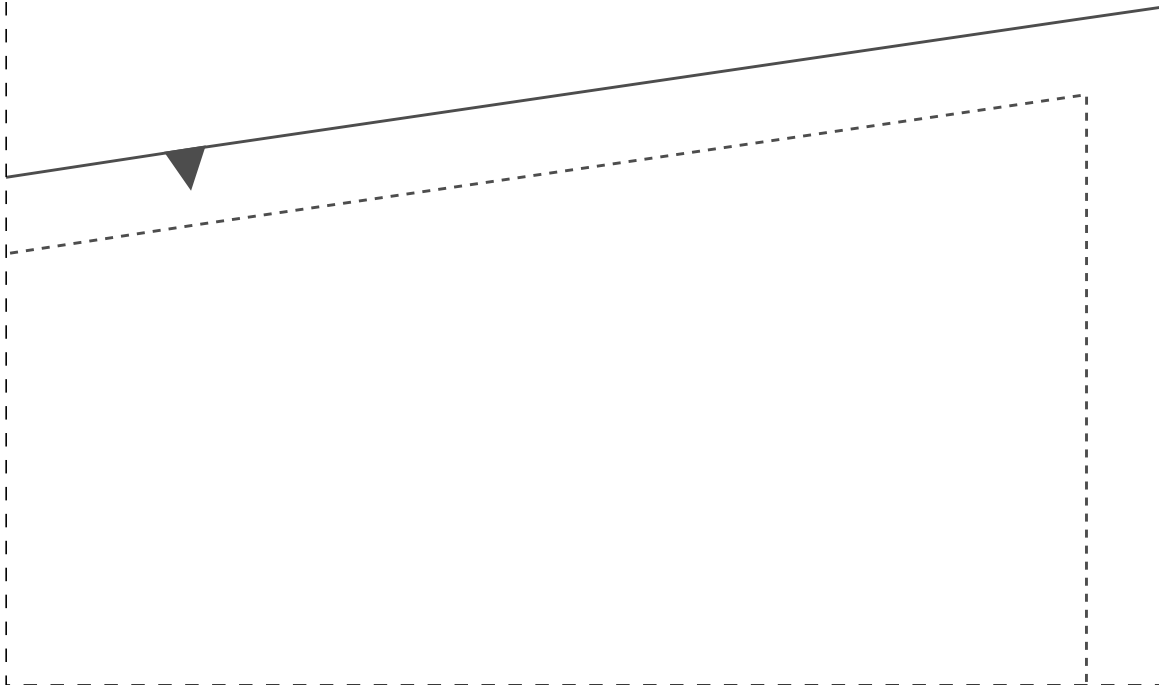

2-2

IDDED CD105



3-2

revel/bolso 2x



1-3

alça 2x
46

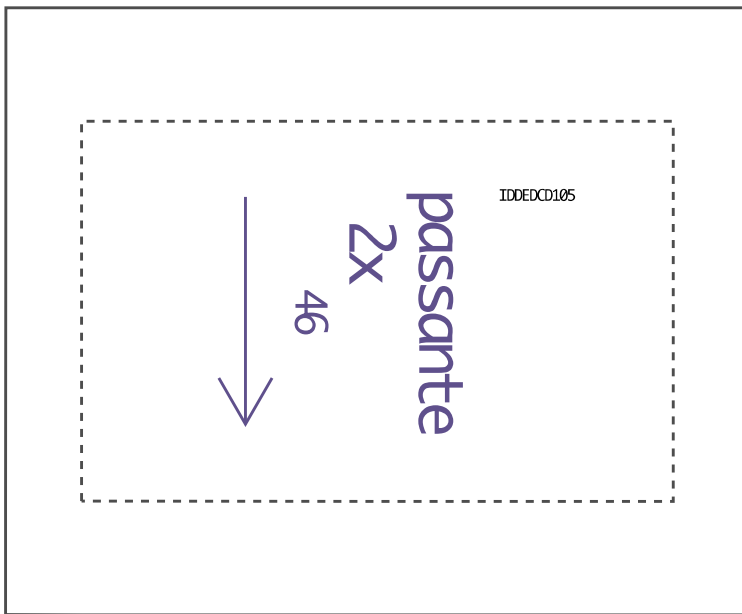

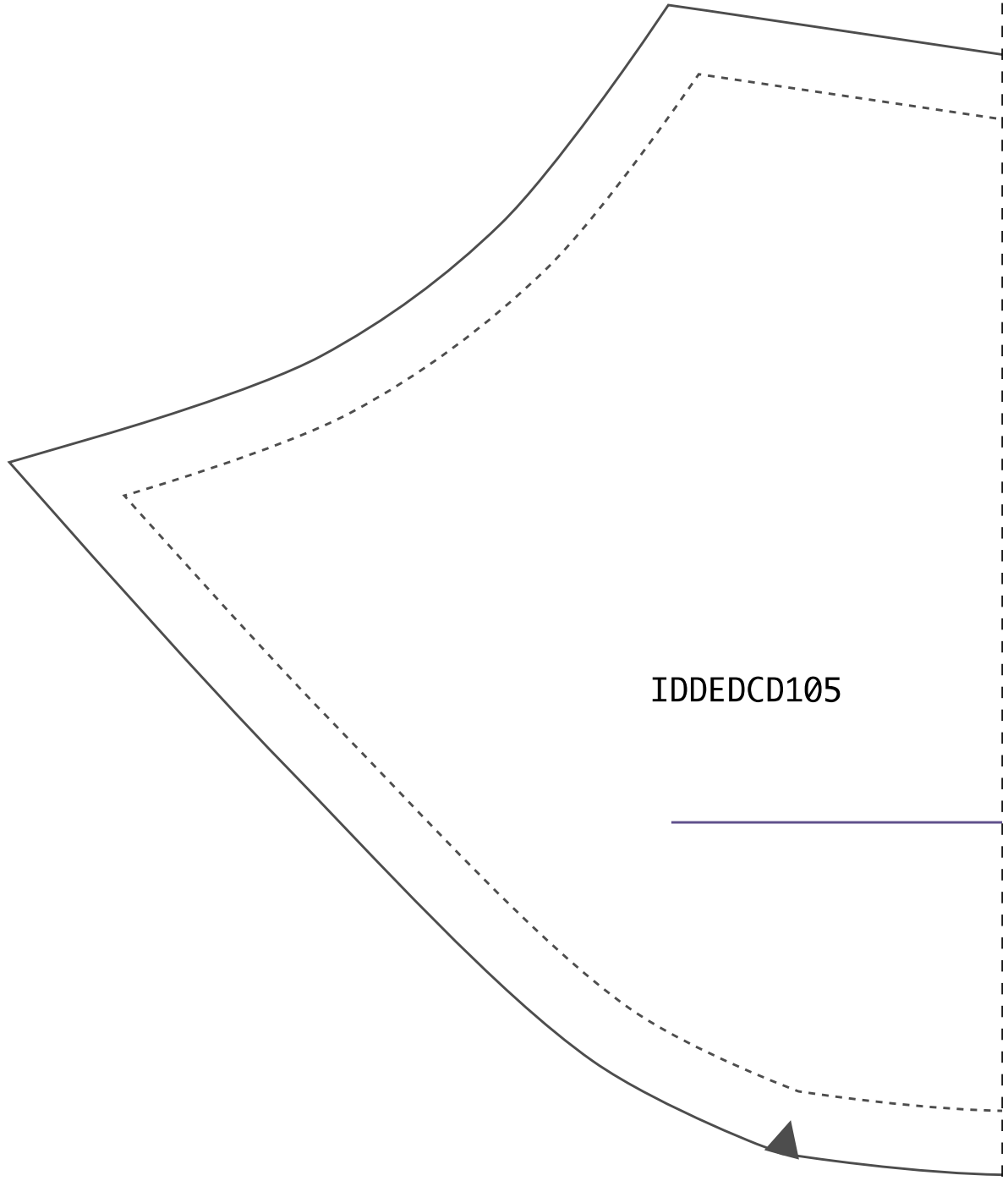

IDDEDCD105

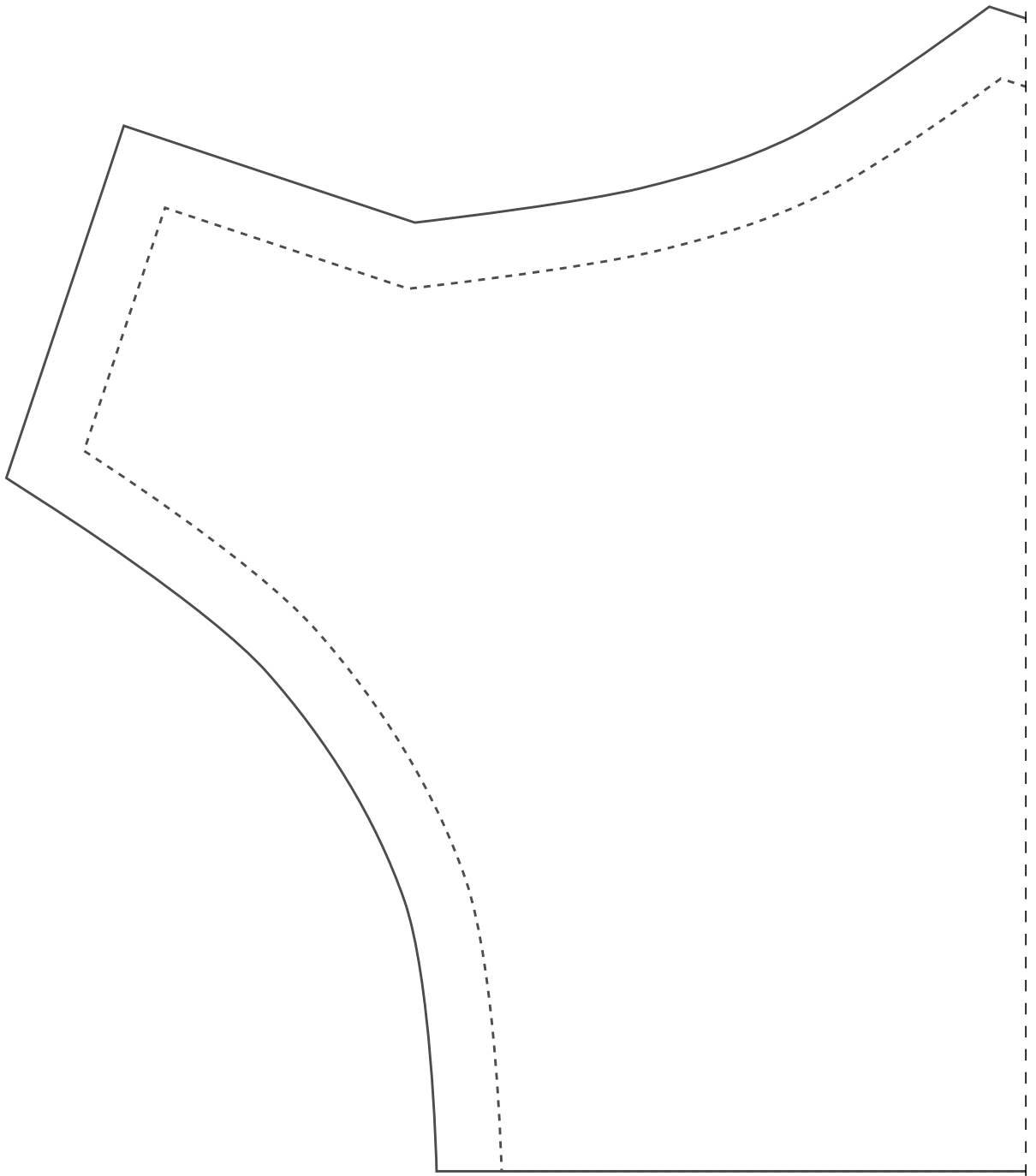

IDDED CD105

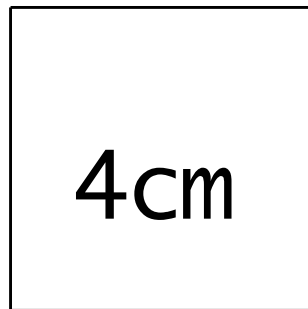

Teste de impressão: ao imprimir seu molde, meça o quadrado que deverá ter a mesma medida informada (4cm), assim você se certificará que ele foi impresso no tamanho correto.

2-4

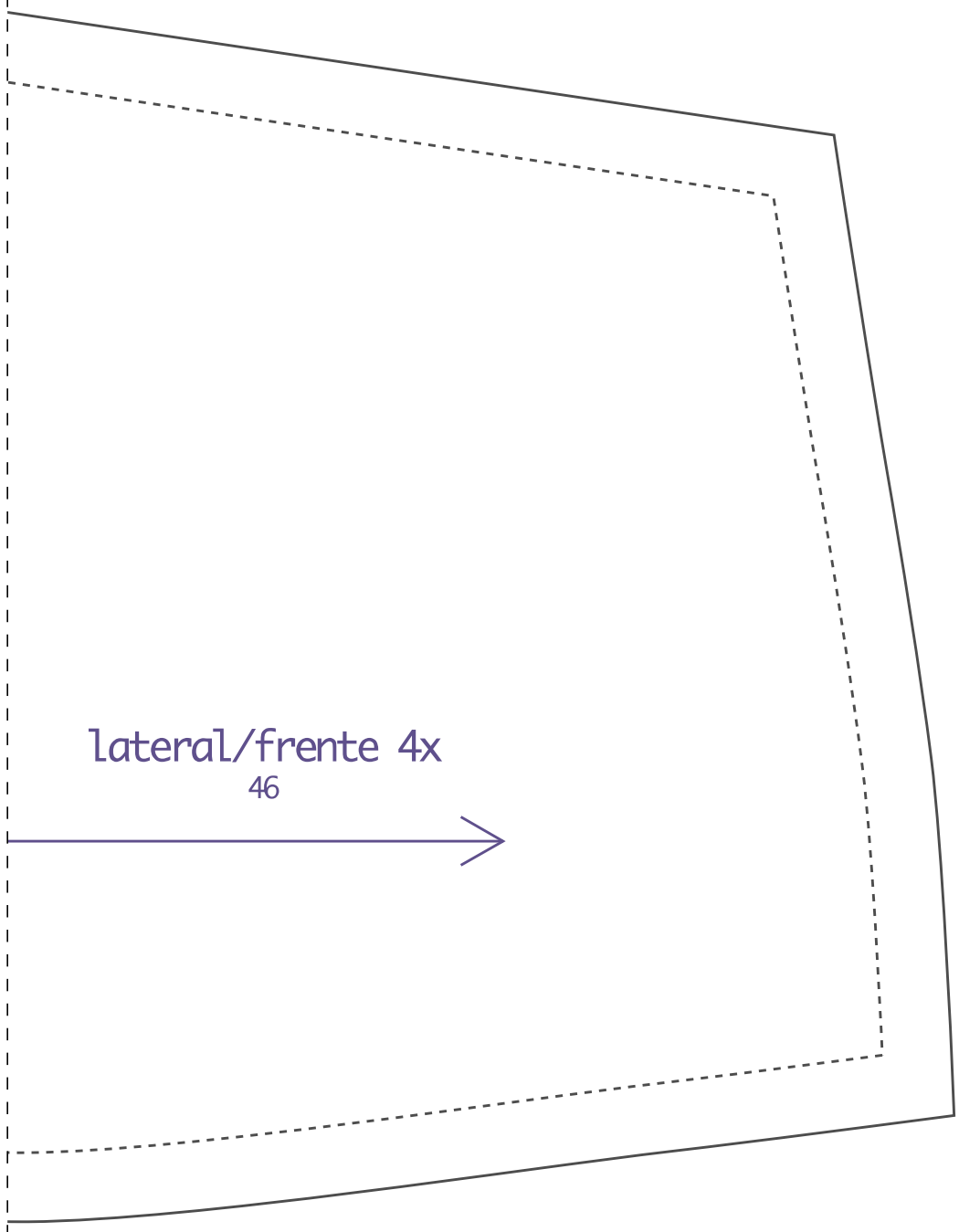

lateral/frente 4x

46



3-4

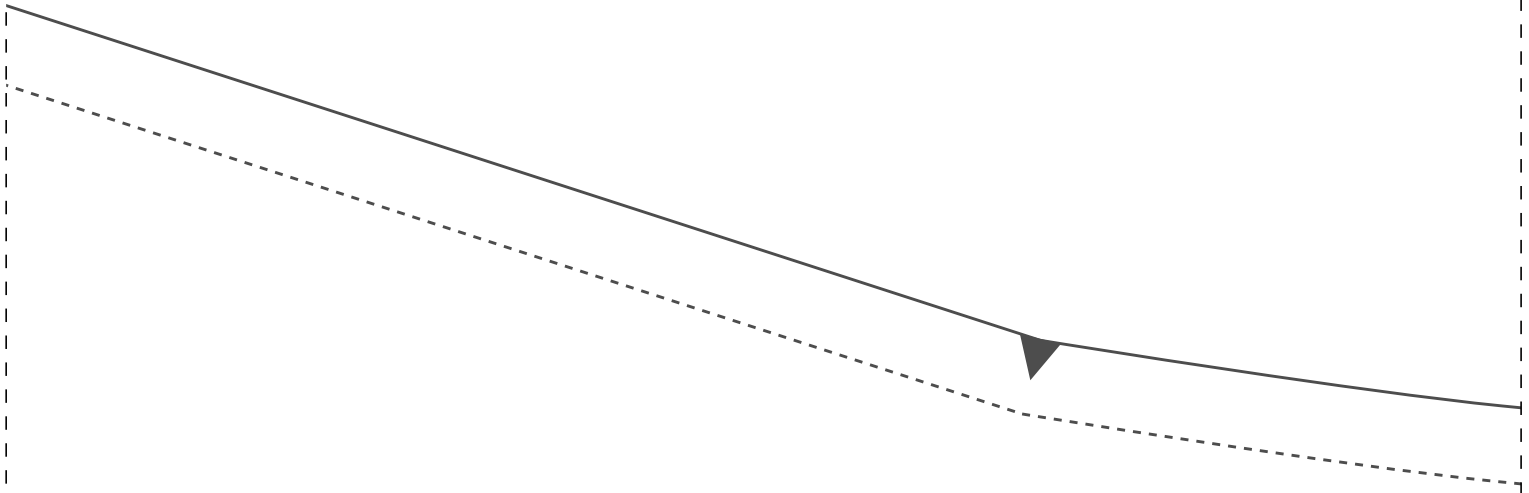

IDDED CD105

frente 2x
46

dobra

1-5

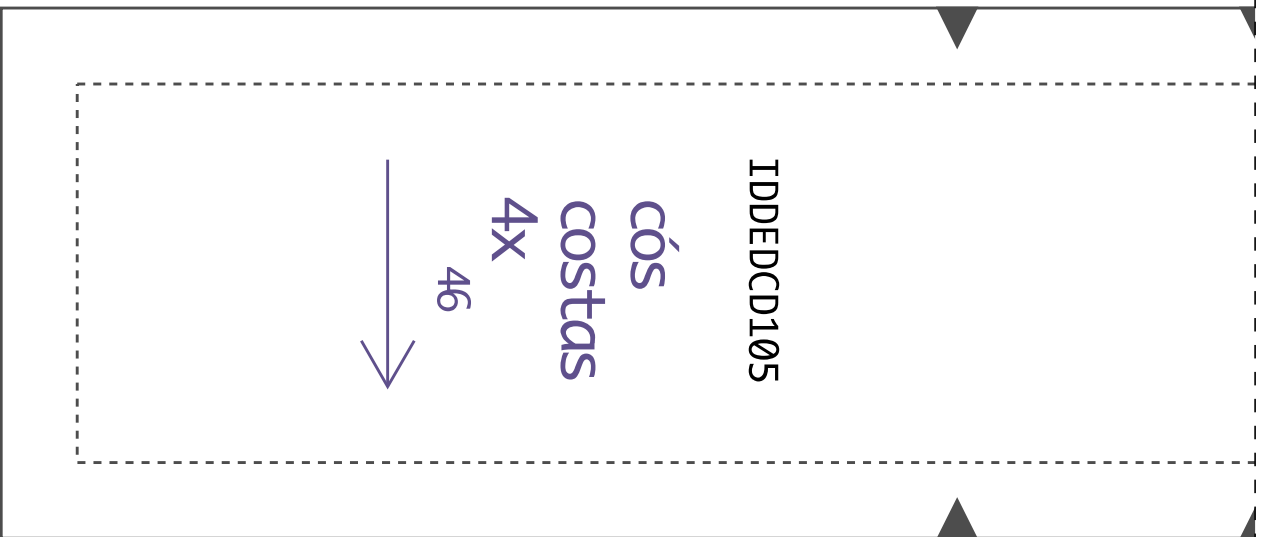

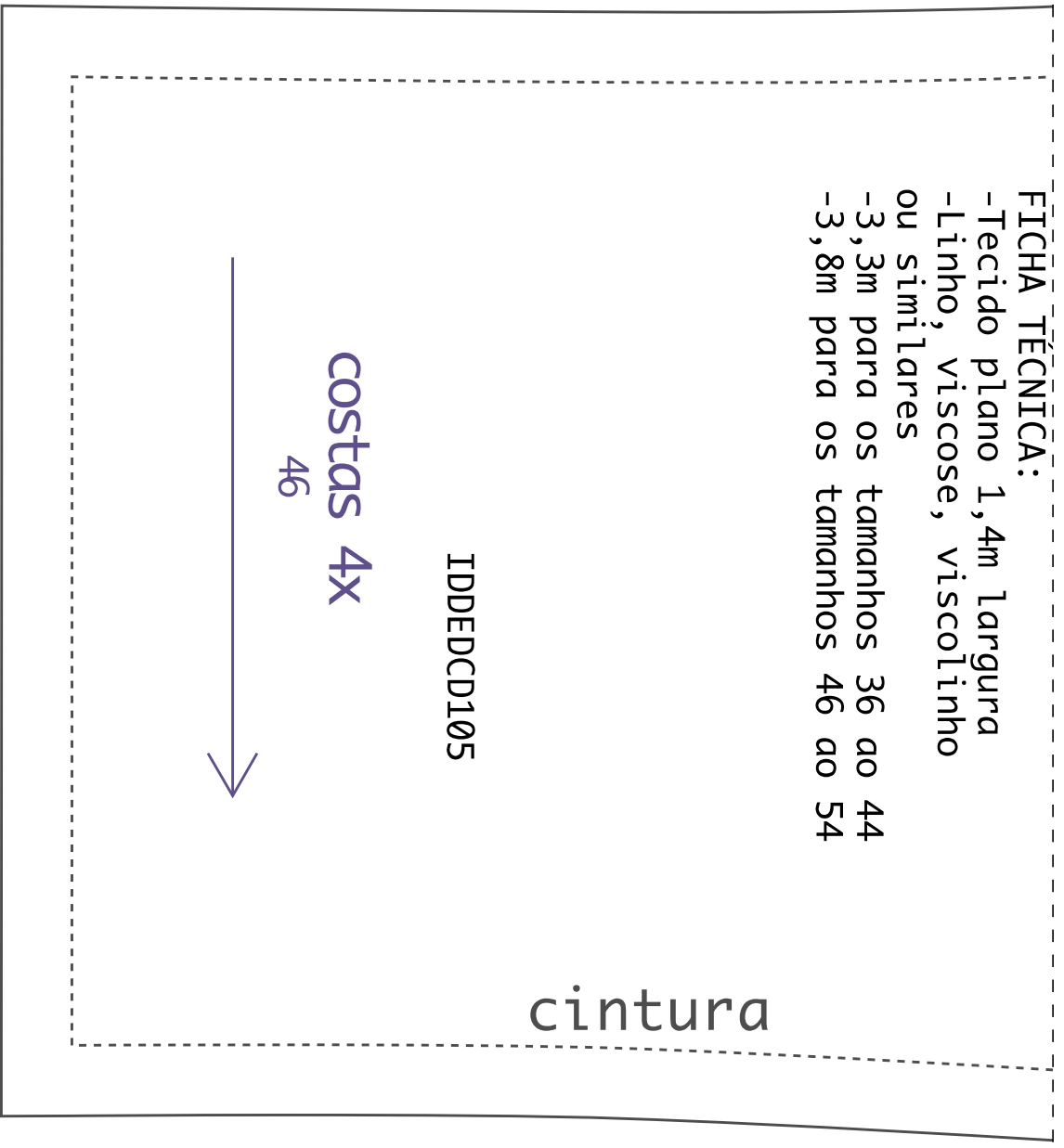

3-5

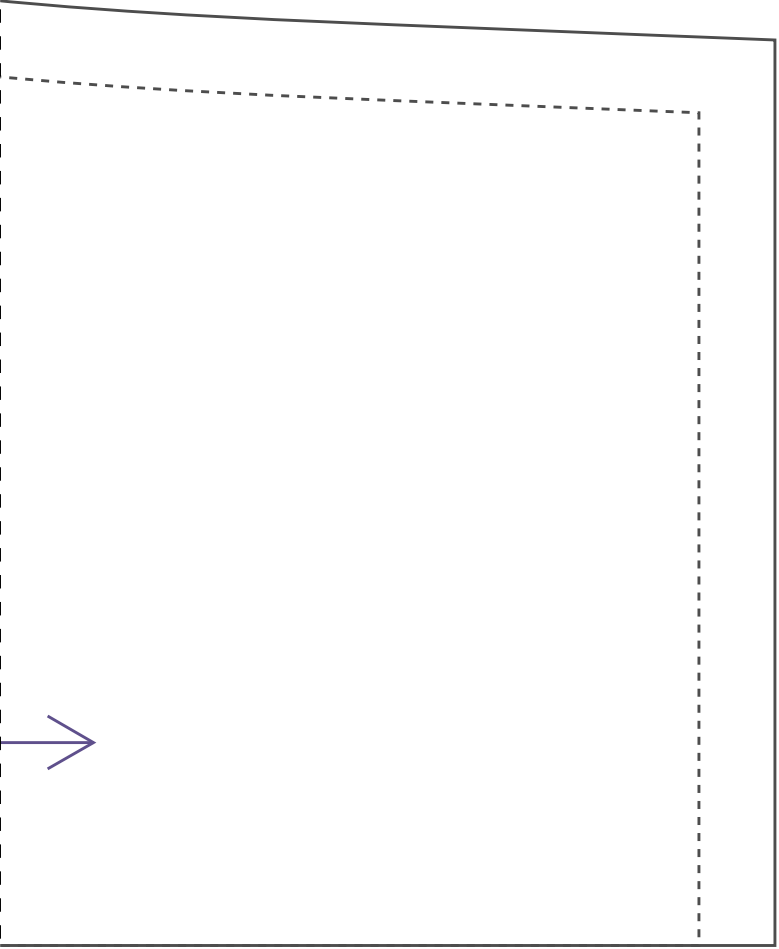
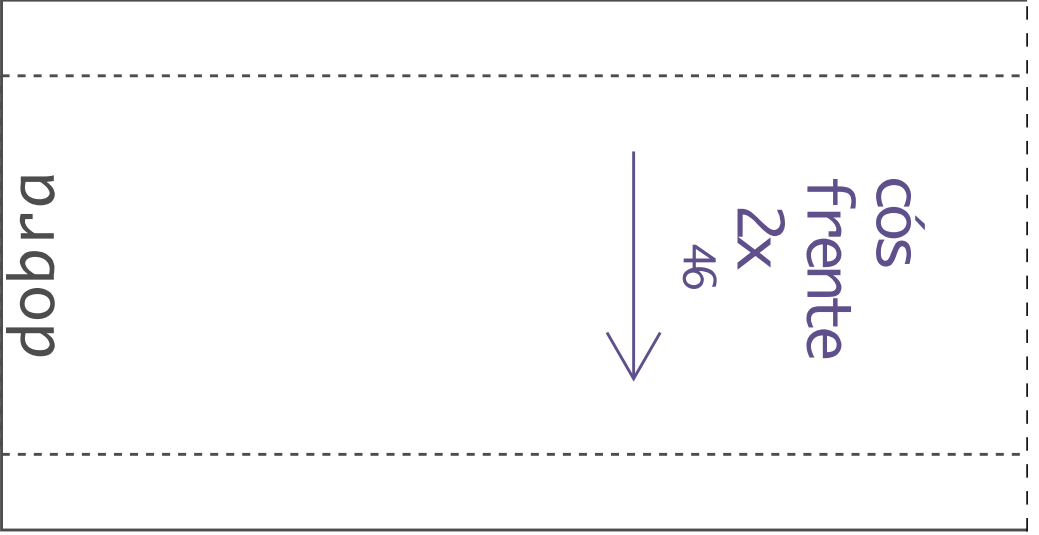

1-6

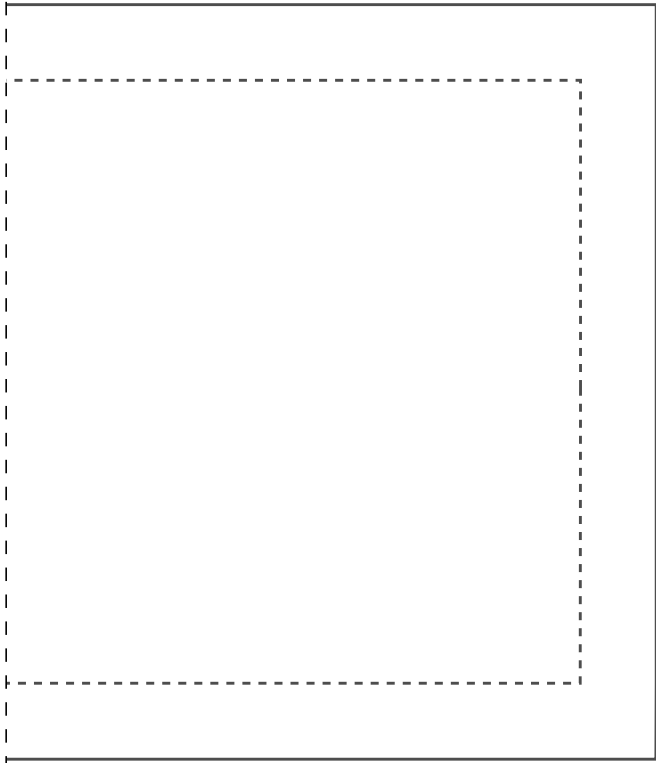

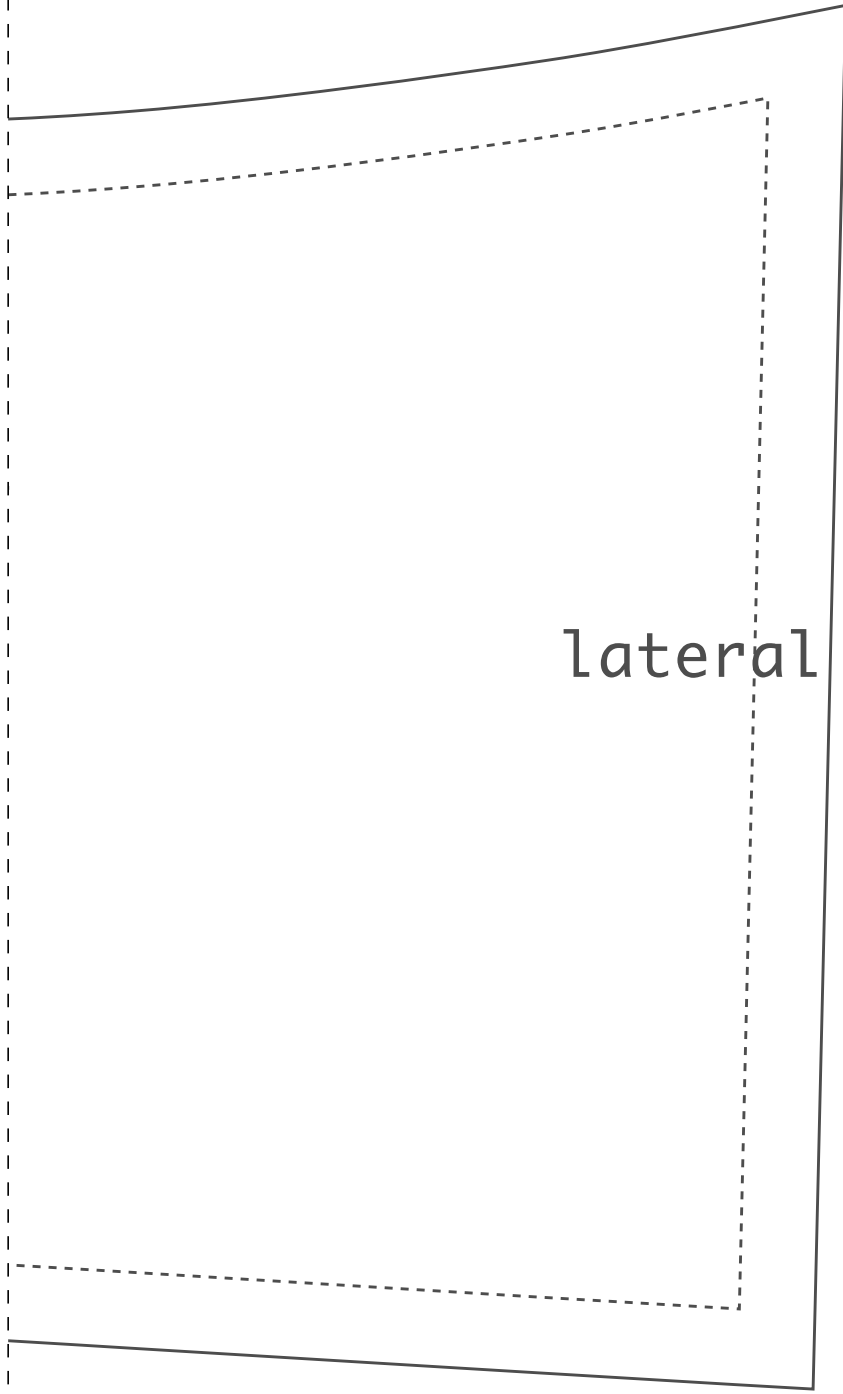

lateral

3-6

IDDIEDCD105