

1-1

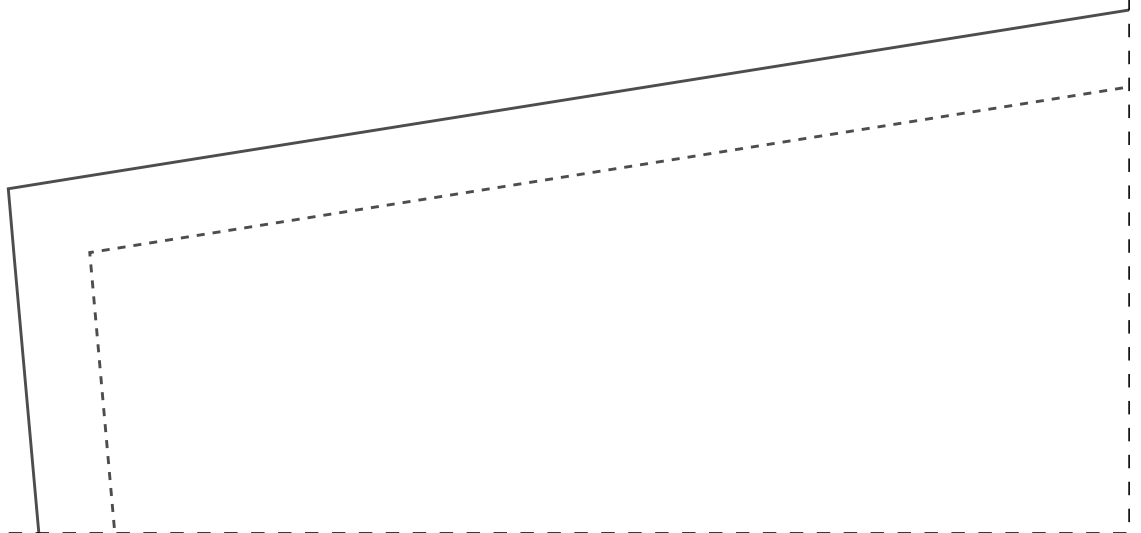

2-1

FICHA  
Teci  
-Cre  
Gaba  
-Cós  
cort  
36:  
42:  
48:  
54:  
-2,3  
-2,5

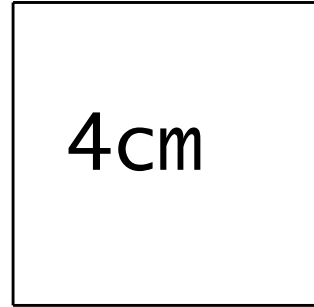
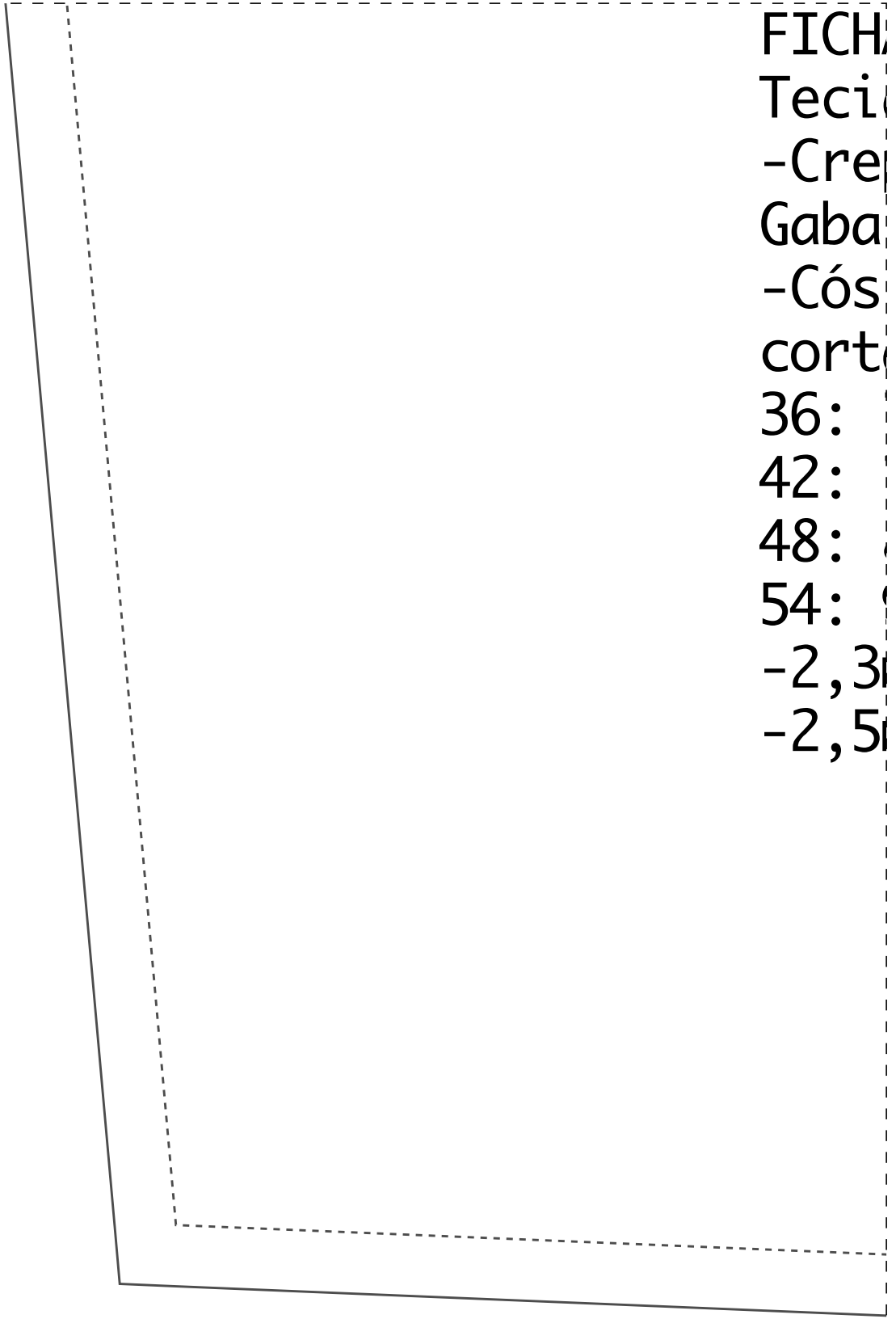

Teste de impressão: ao imprimir seu molde, meça o quadrado que deverá ter a mesma medida informada (4cm), assim você se certificará que ele foi impresso no tamanho correto.

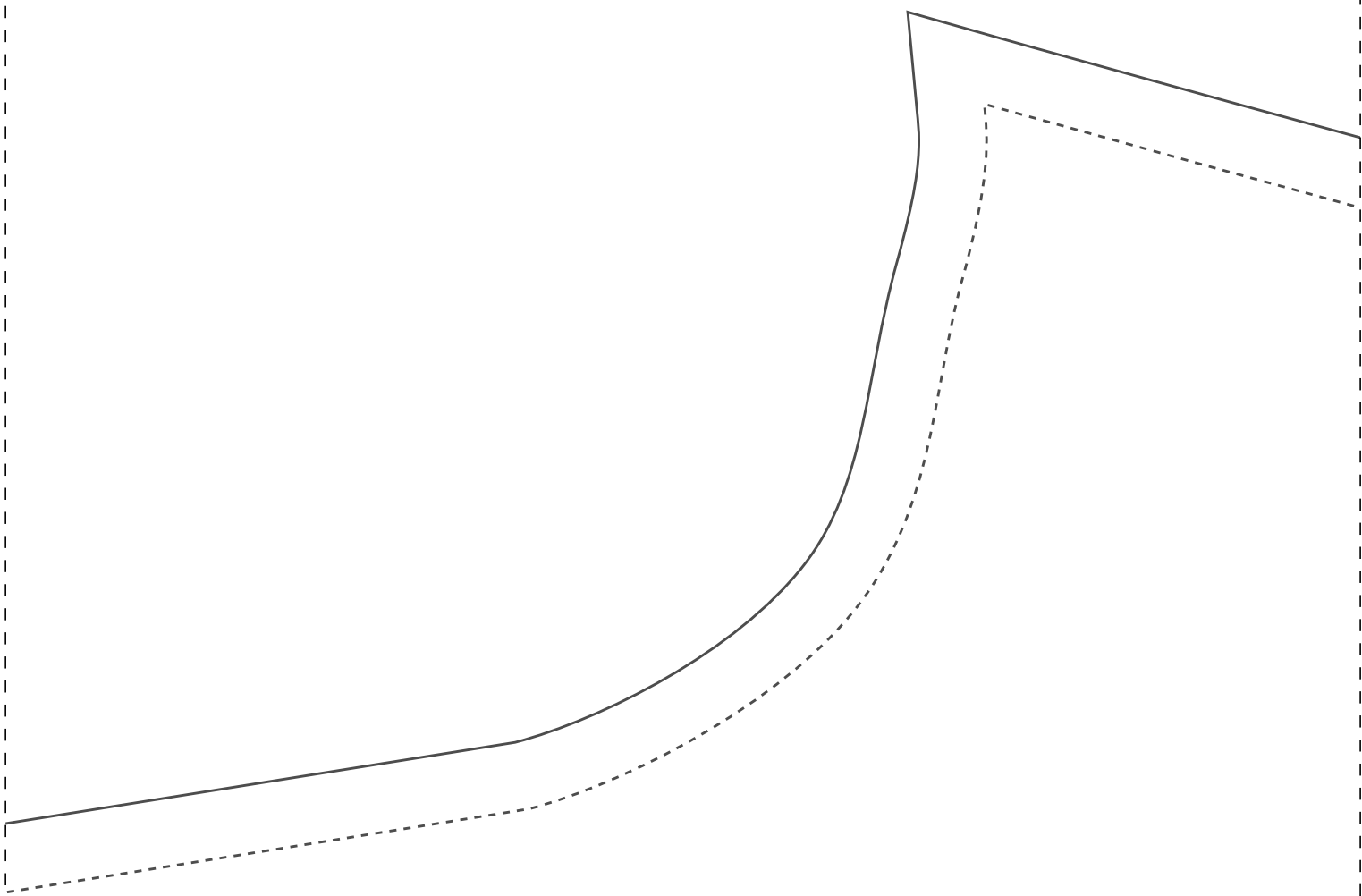

A-2 TÉCNICA:

do Plano 1,4m larg  
pe Flow, Oxfordine,  
rdine, brim leve ou similares  
com elástico 4cm,  
ar elástico com:

72cm / 38: 74cm / 40: 76cm

78cm / 44: 80cm / 46: 82cm

84cm / 50: 86cm / 52: 88cm

90cm

m do 36 ao 44

m do 46 ao 54

1-3

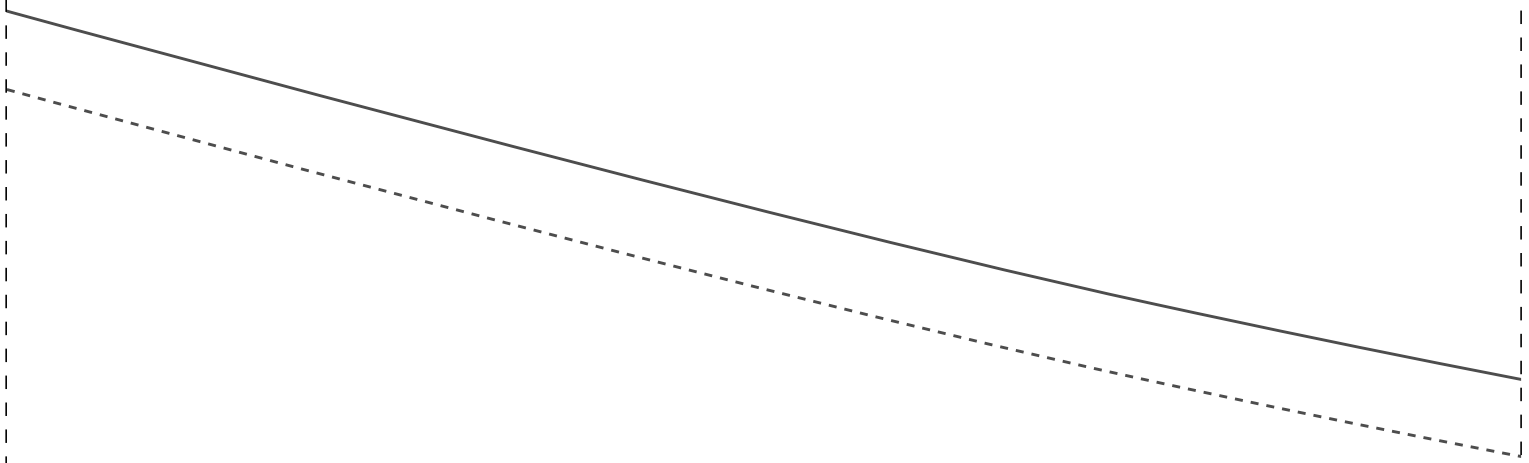

TRASEIRO 2X  
36



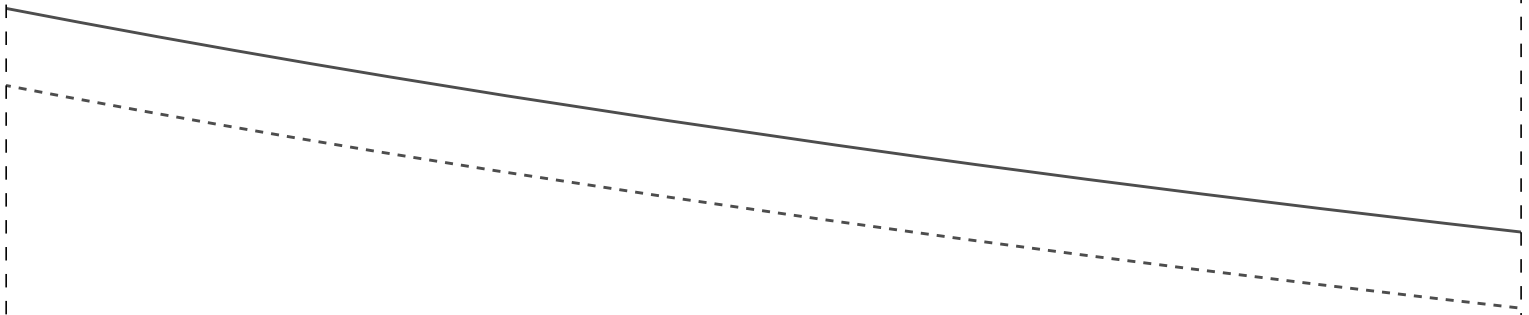

IDDS03



1-5

DOBRA

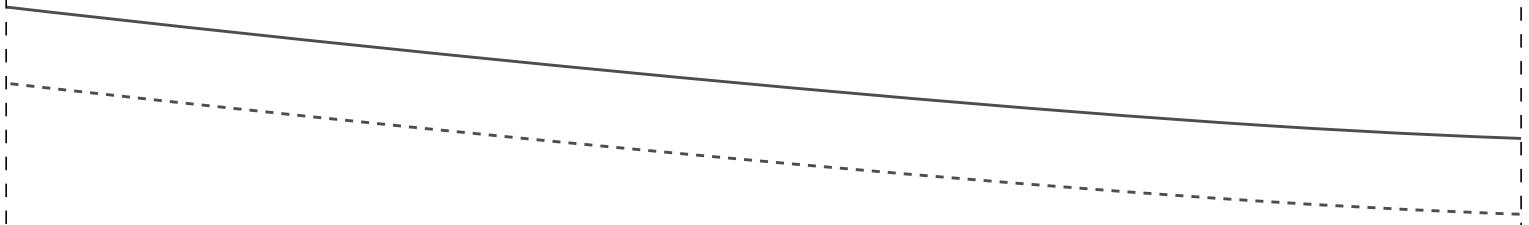

2-5

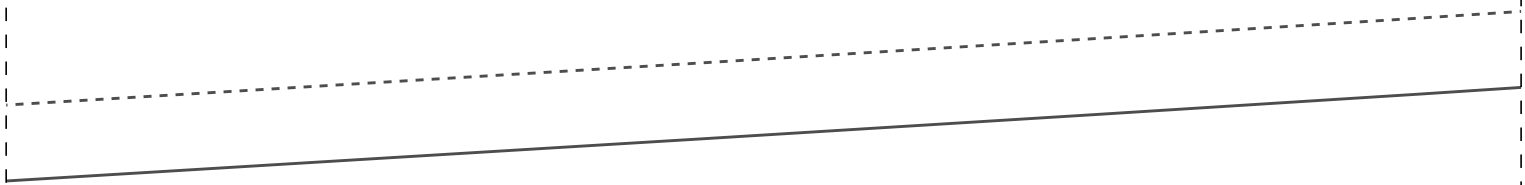

1-6

IDD503

COS 2X  
36

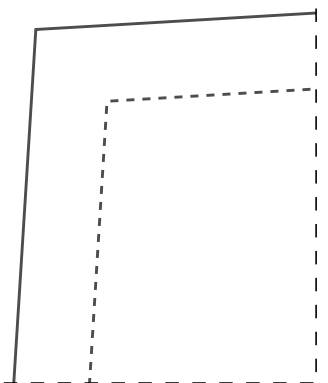
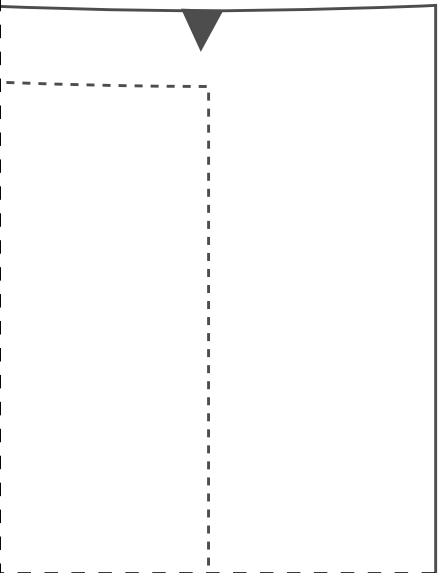

2-6

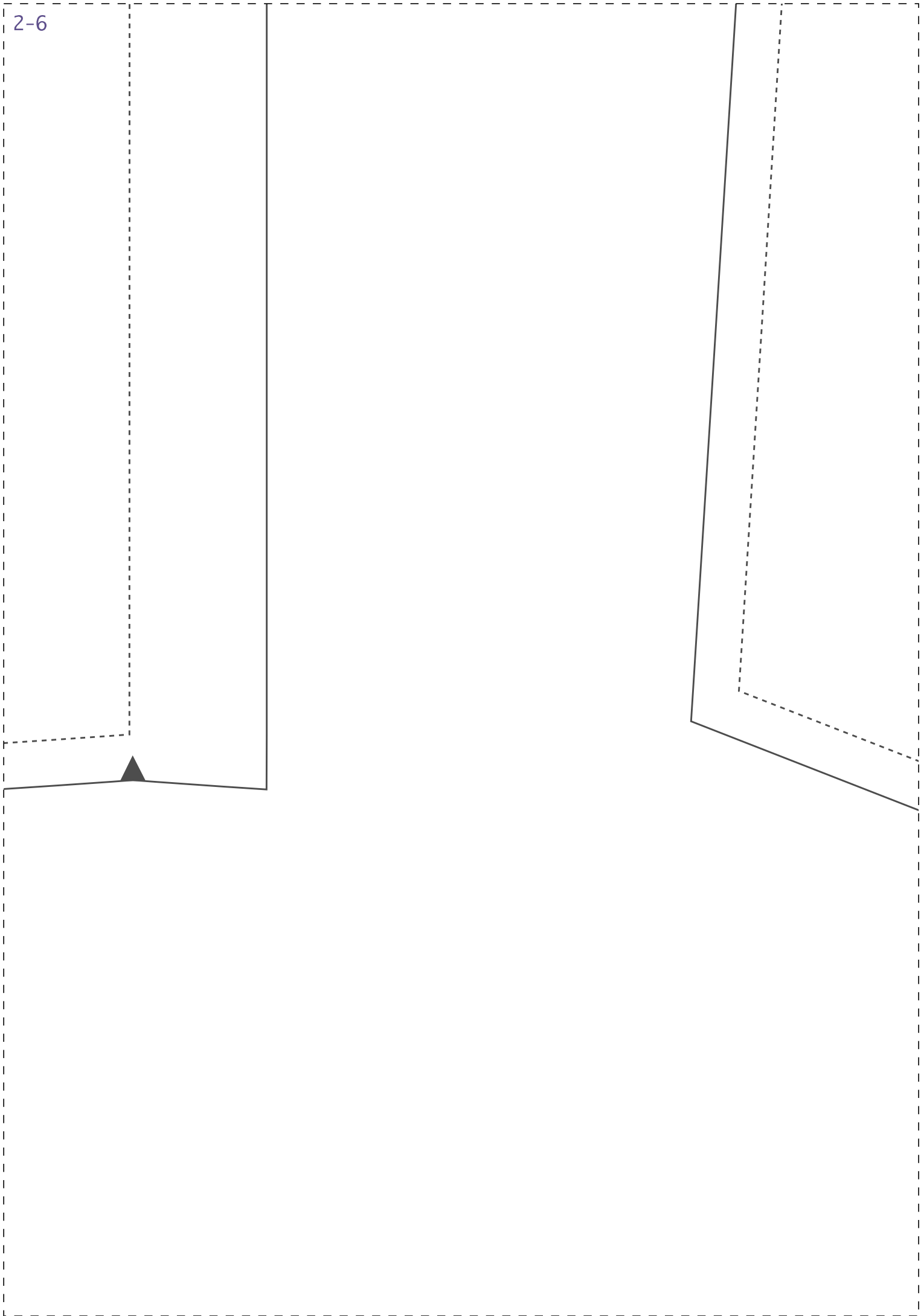

1-7

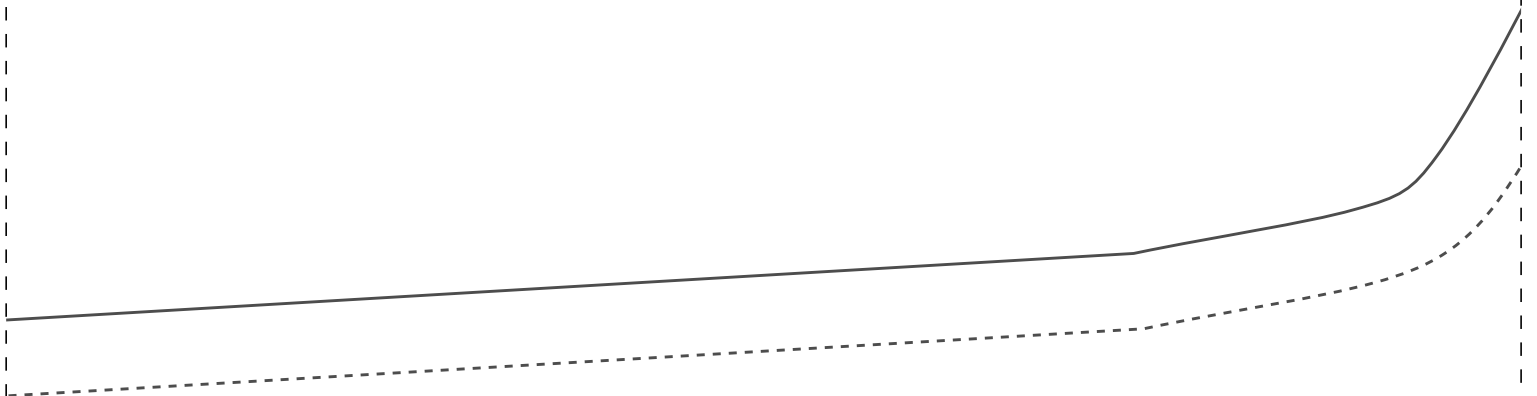

---

Instituto Diana Demarchi  
Curso de Uniformes da Saúde  
Calça Pijama Cirúrgico  
Feminino

**PROIBIDA REVENDA**

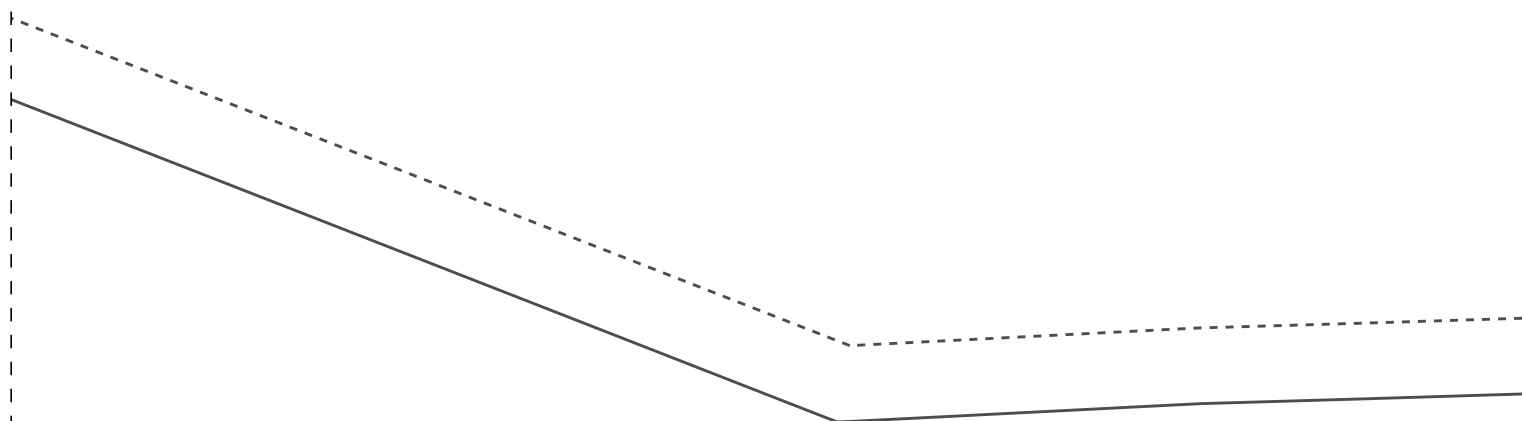

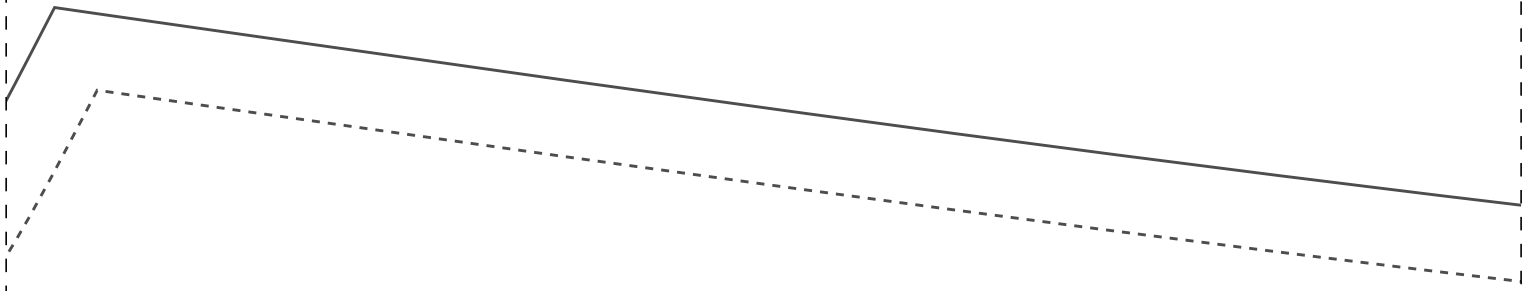

DIANTEIRO 2X

36

IDDSO

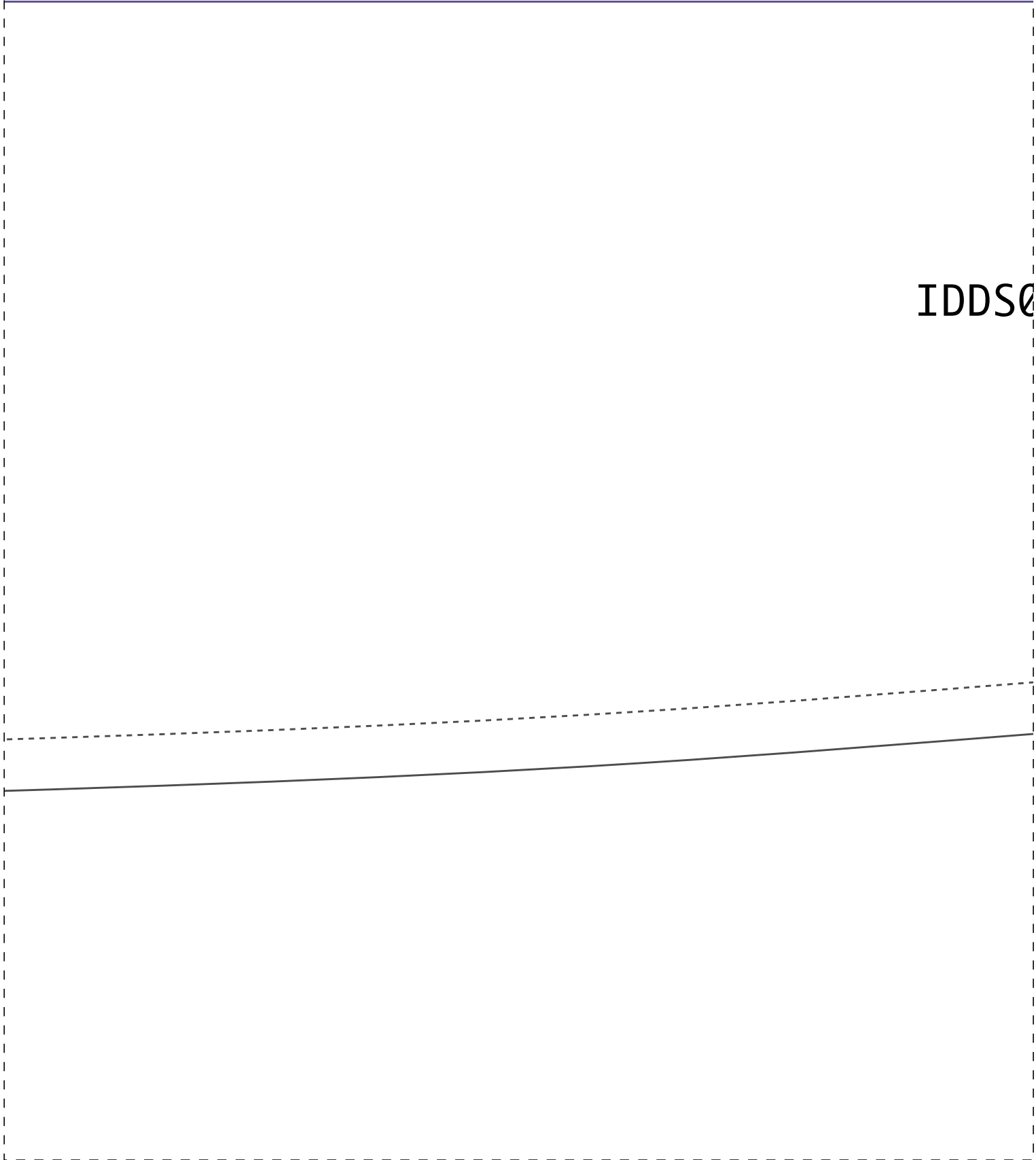



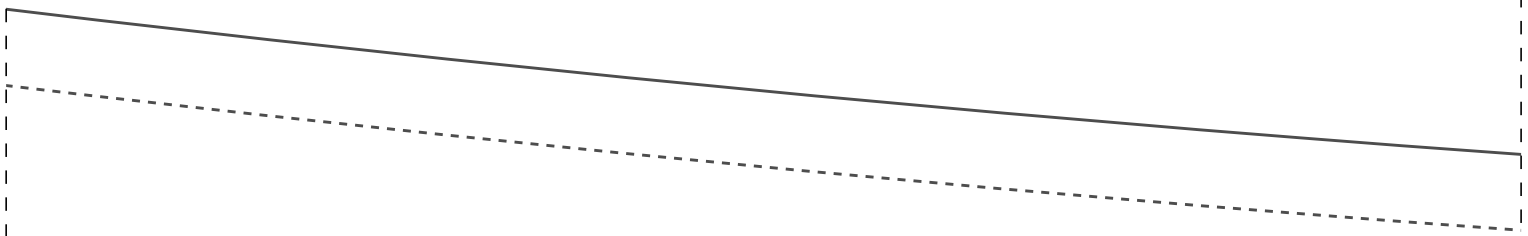

2-9

3

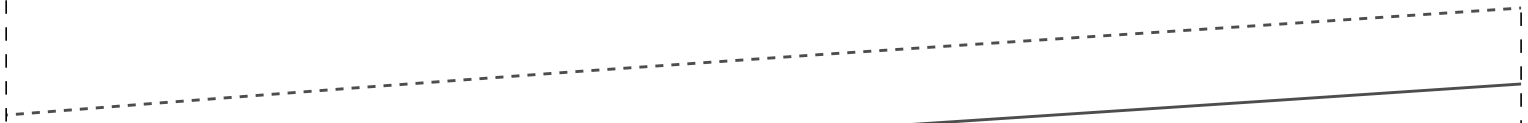

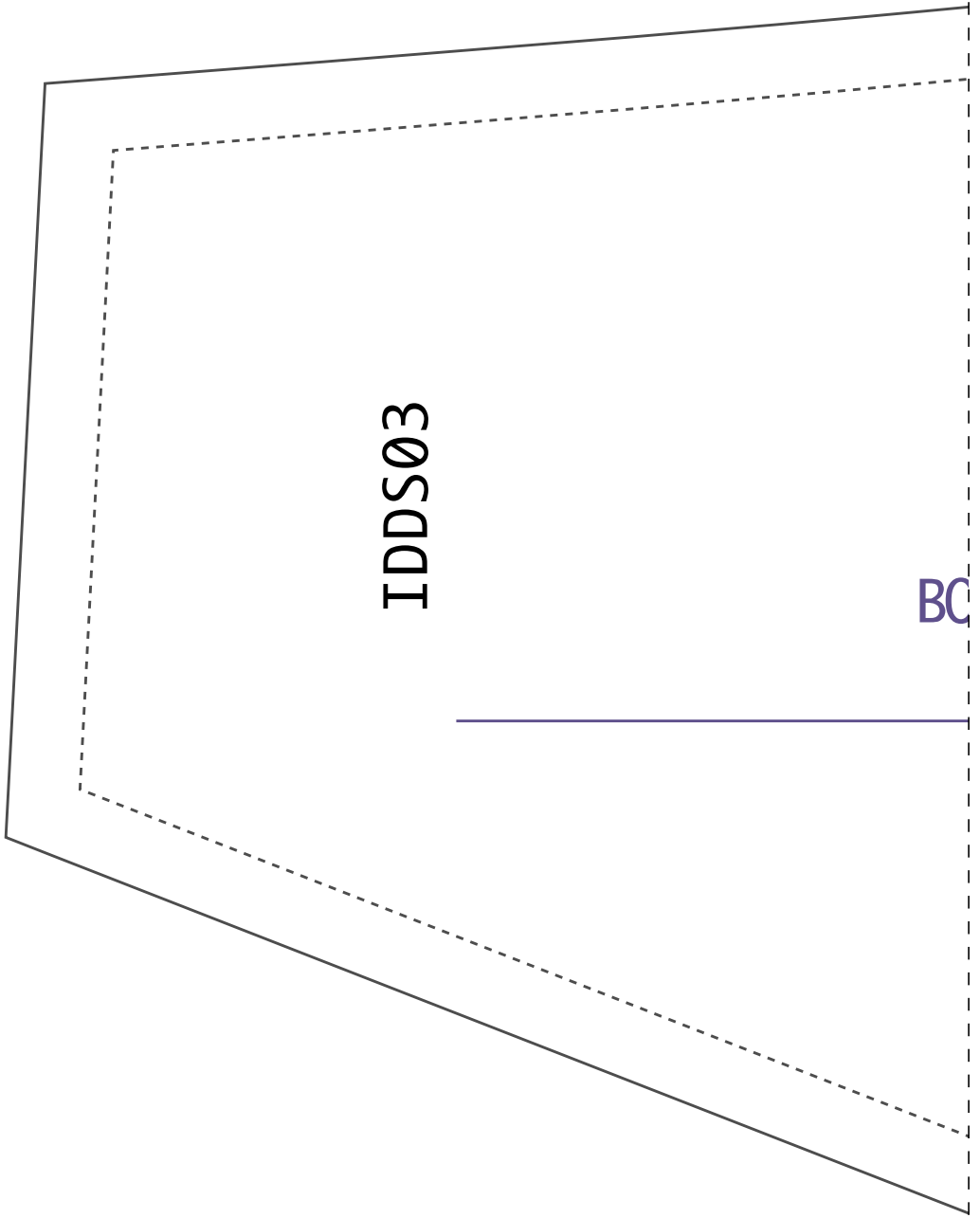

IDDS03

BC

2-10

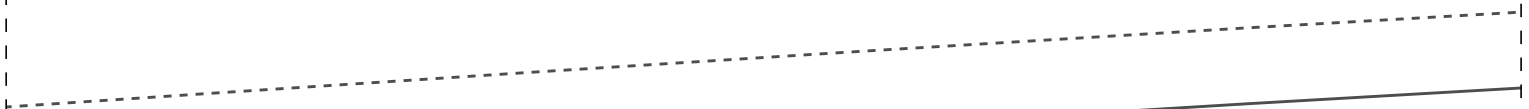

1-11

ALSO 2X

36

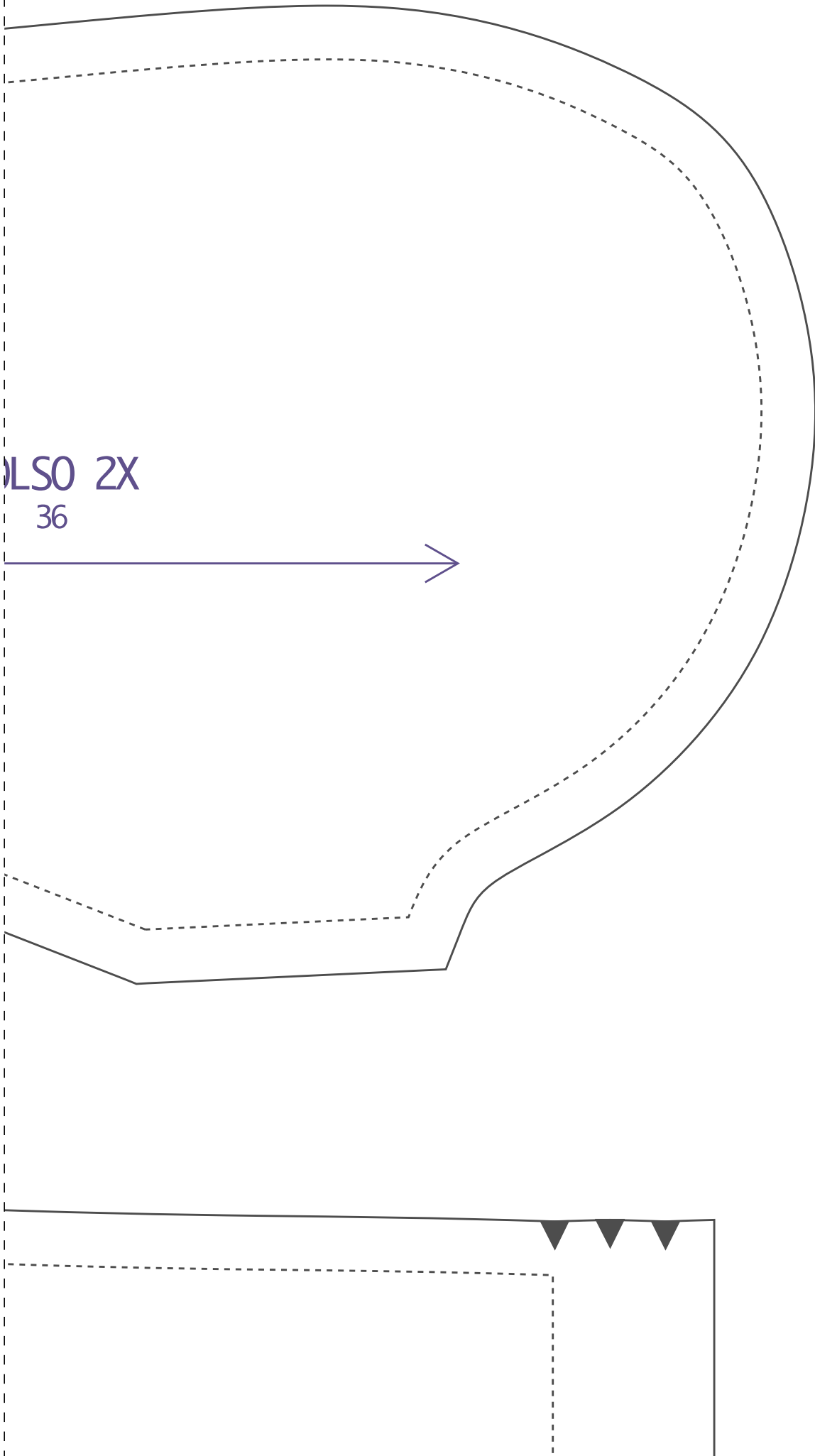

2-11

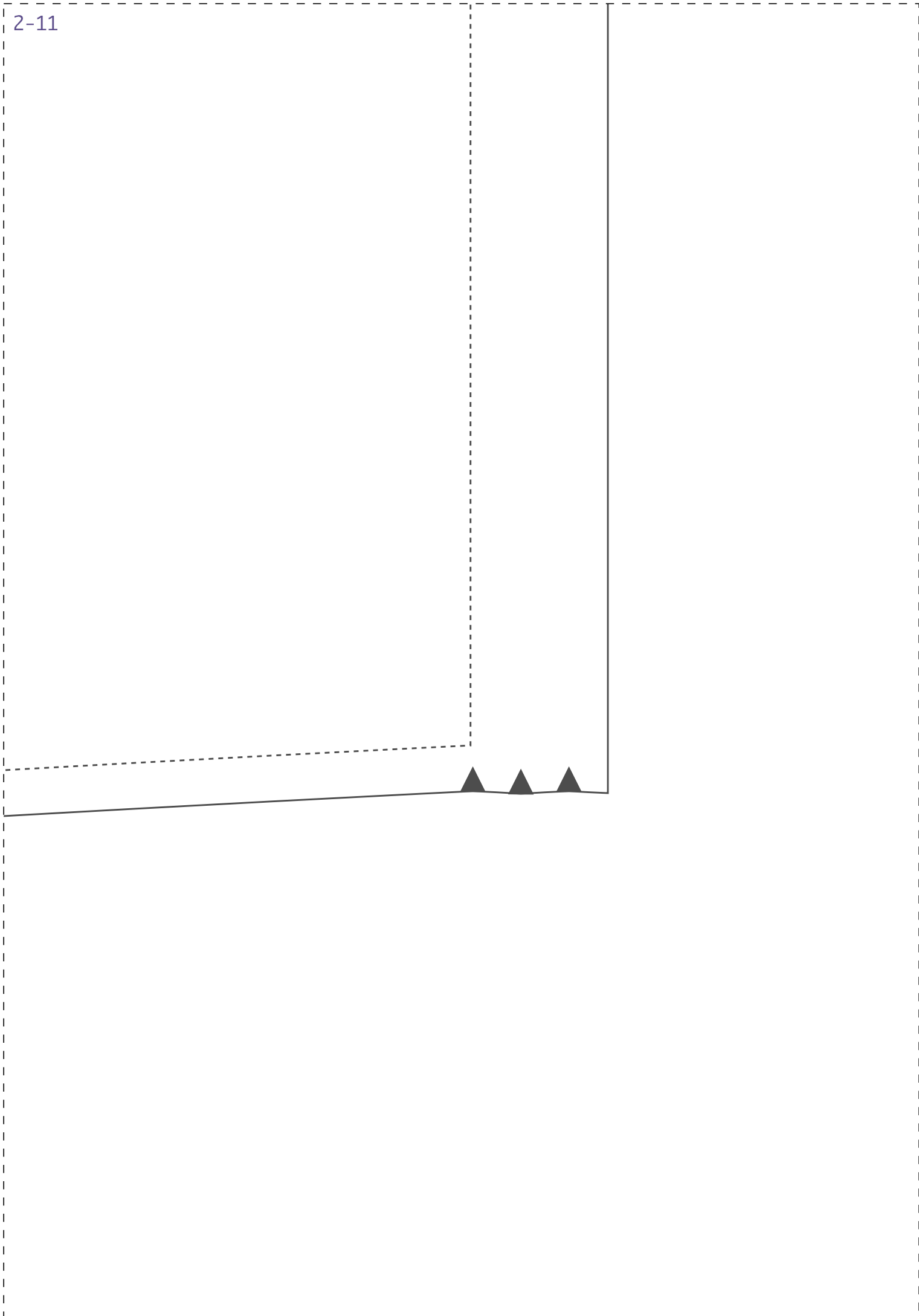

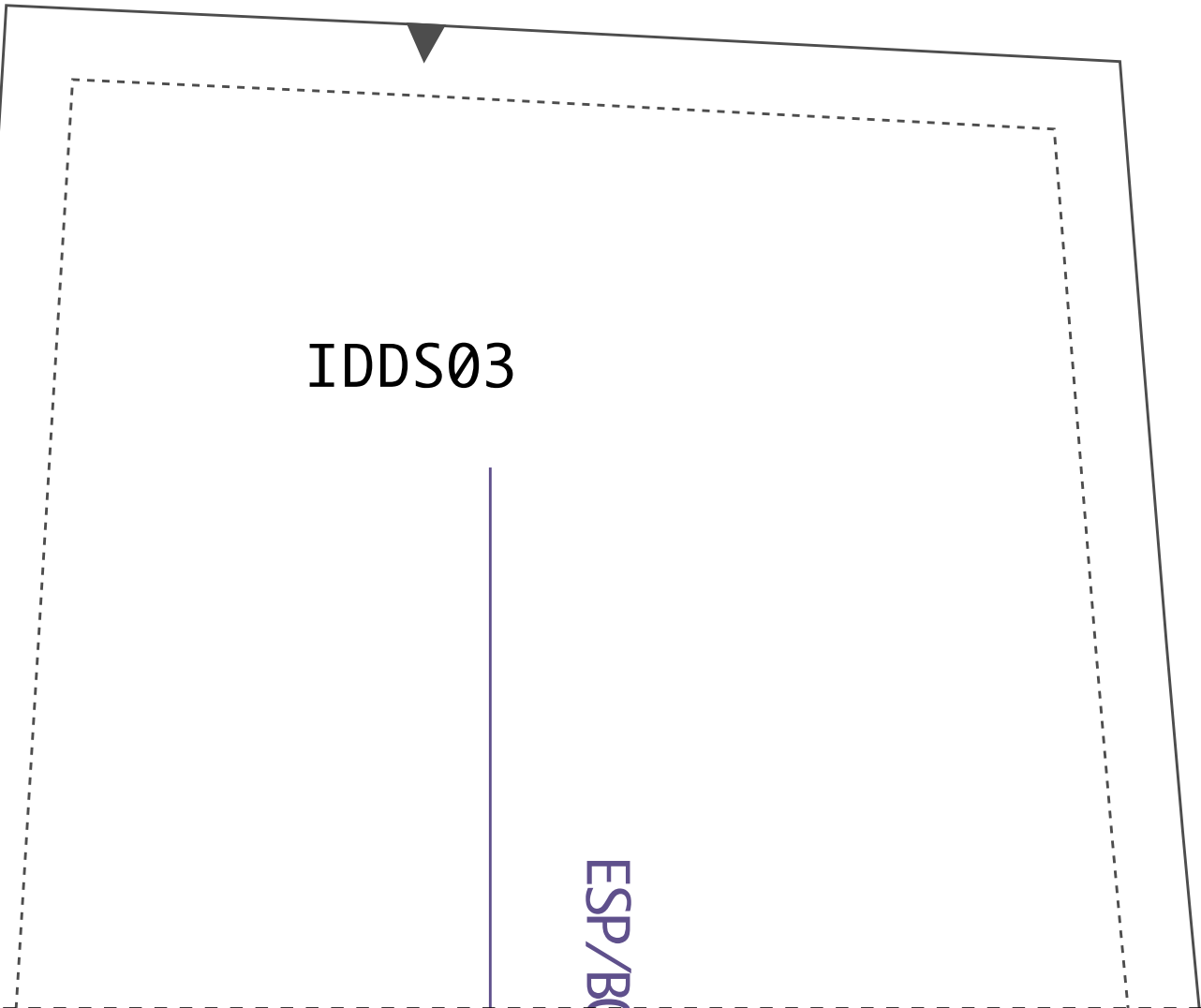

IDDS03

ESP/B

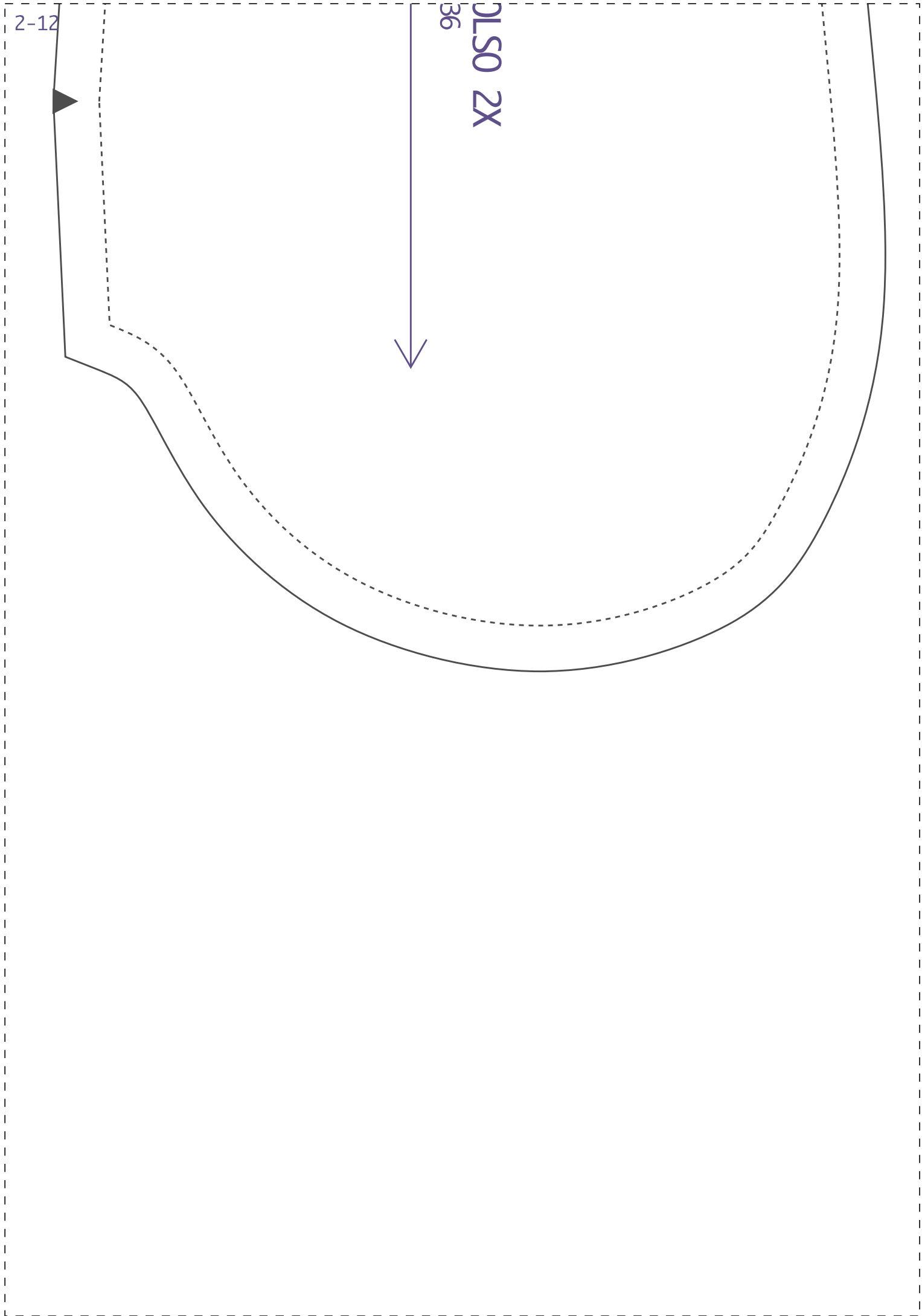

2-12

36

DLSO 2X