

1-1

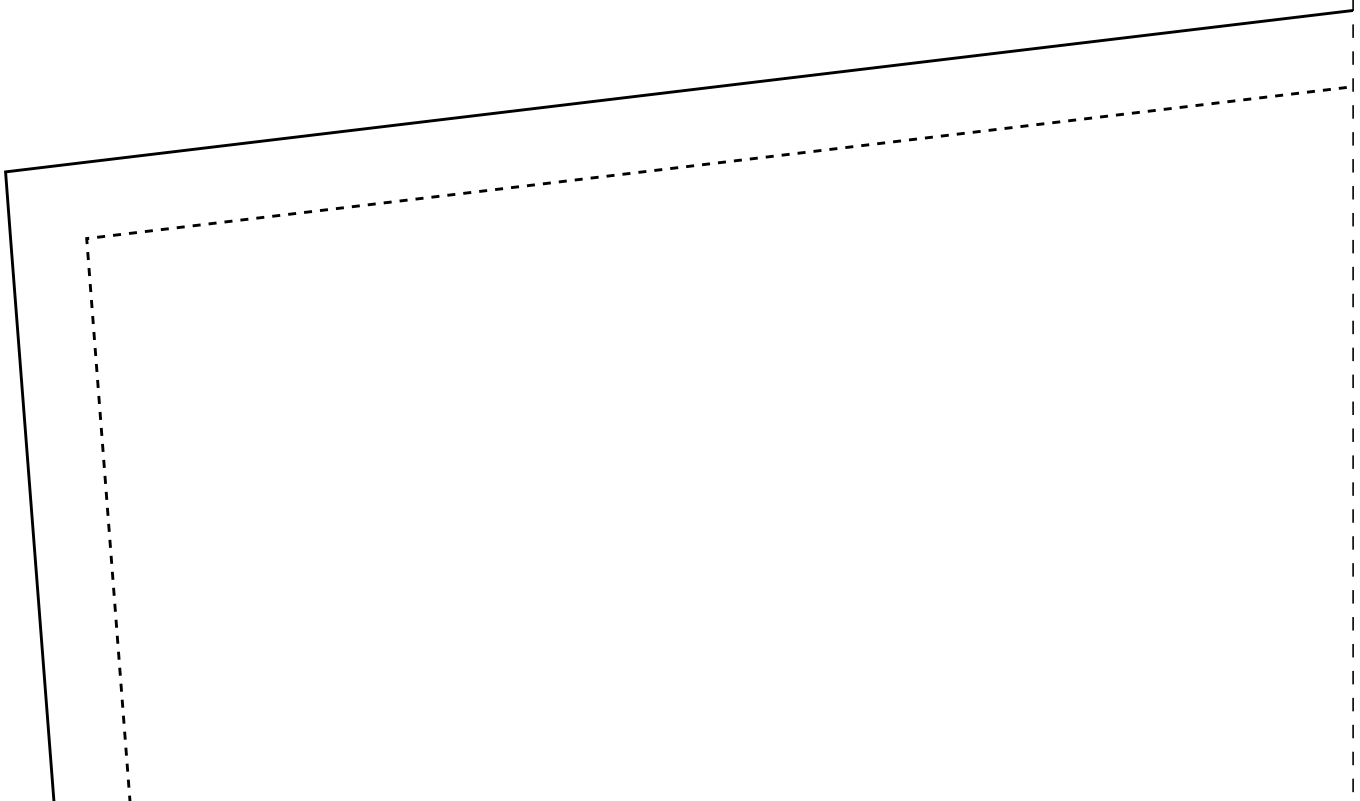

2-1

FICHA
Teci
-Cre
Gaba
-Cós
cort
36:
42:
48:
54:
-2,3
-2,5

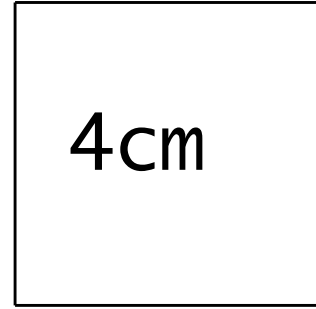
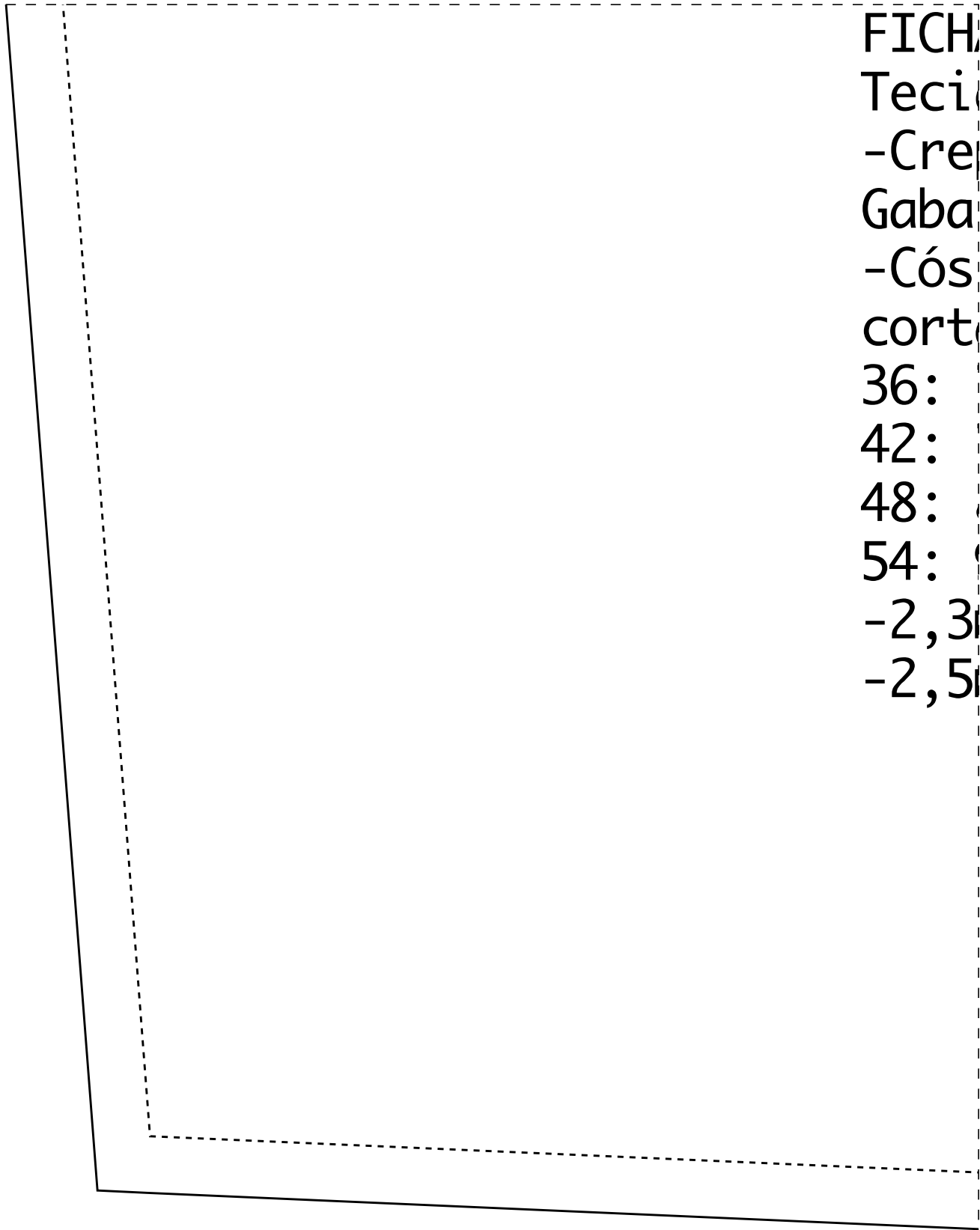

Teste de impressão: ao imprimir seu molde, meça o quadrado que deverá ter a mesma medida informada (4cm), assim você se certificará que ele foi impresso no tamanho correto.

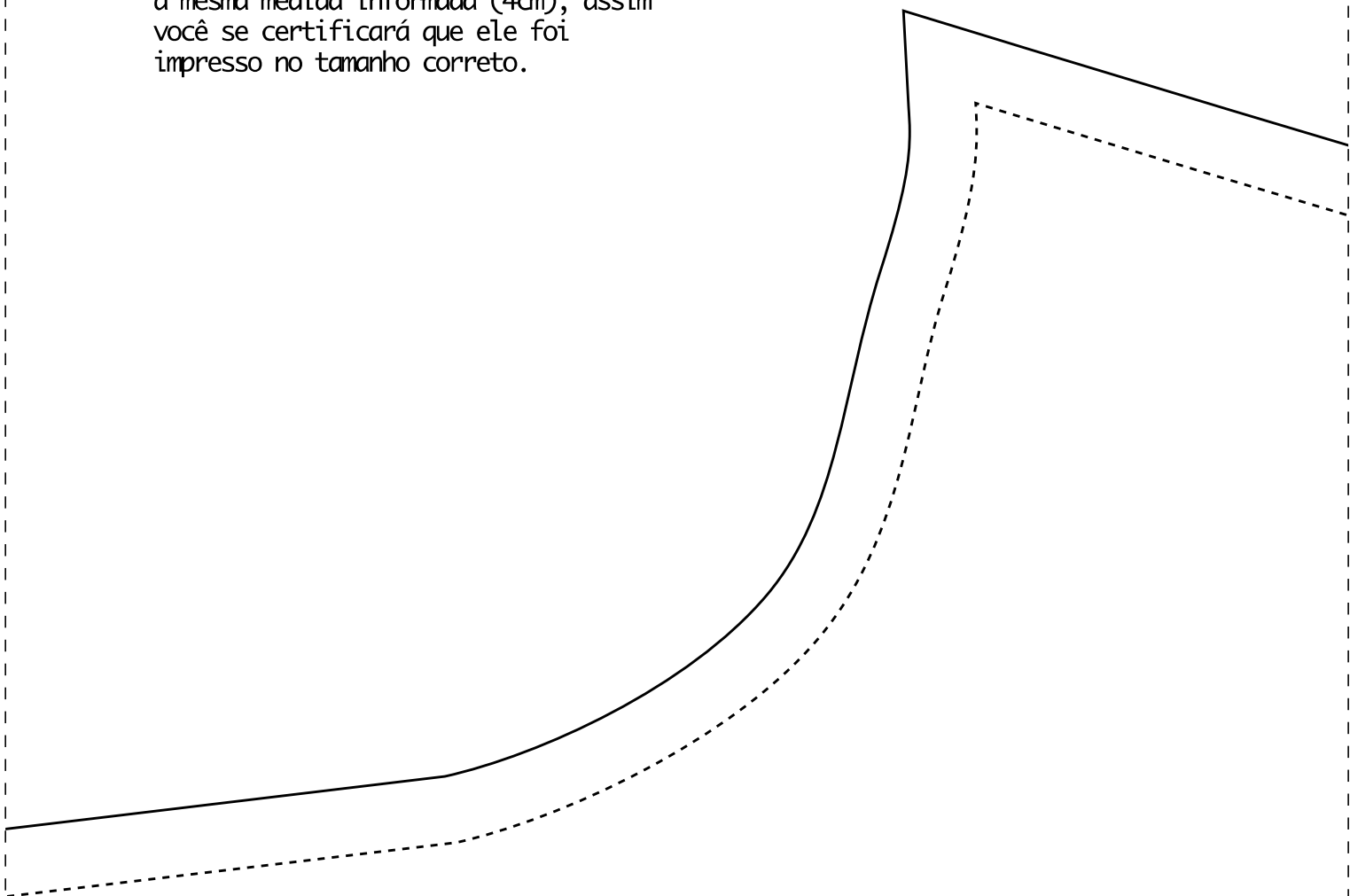

A-2 TÉCNICA:

do Plano 1,4m larg
pe Flow, Oxfordine,
rdine, brim leve ou similares
com elástico 4cm,
ar elástico com:

72cm / 38: 74cm / 40: 76cm

78cm / 44: 80cm / 46: 82cm

84cm / 50: 86cm / 52: 88cm

90cm

m do 36 ao 44

m do 46 ao 54

1-3

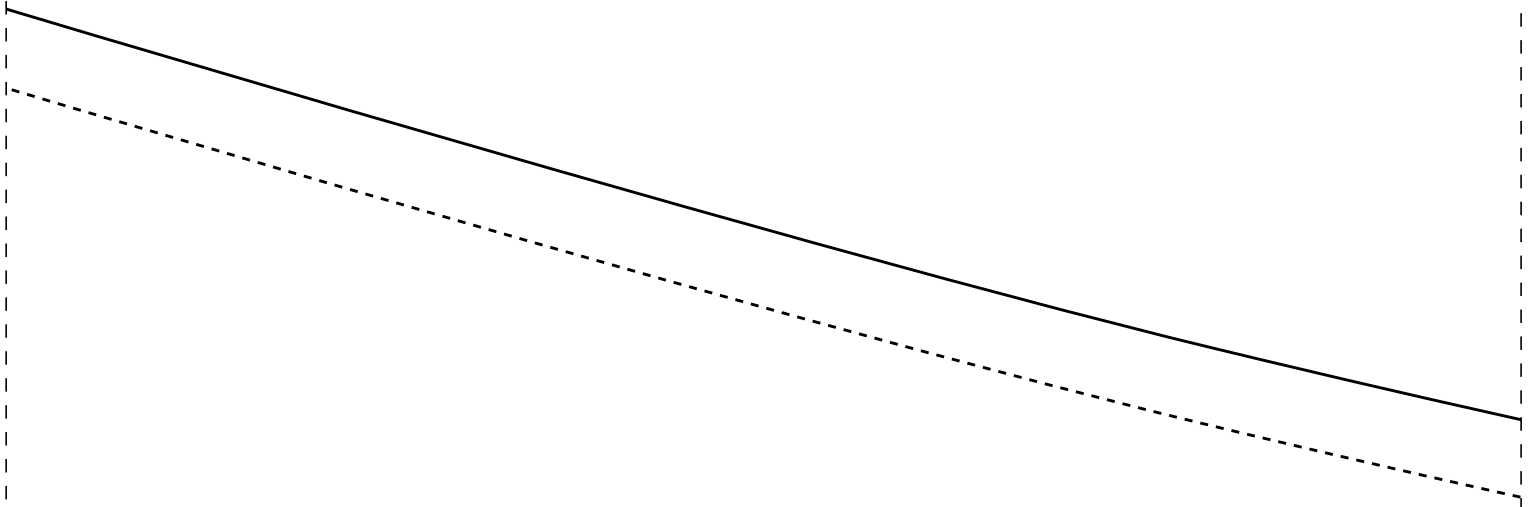

TRASEIRO 2X

42

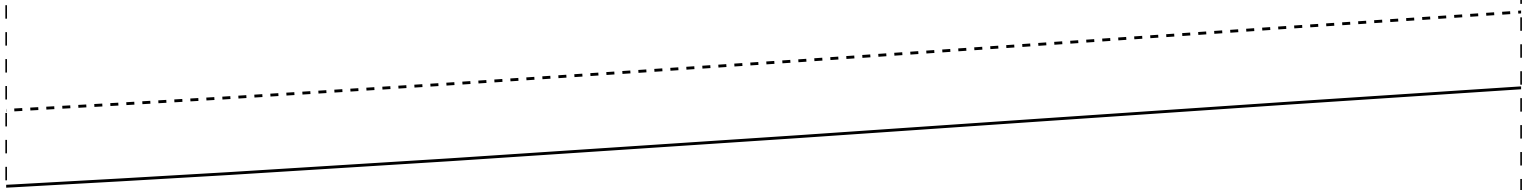

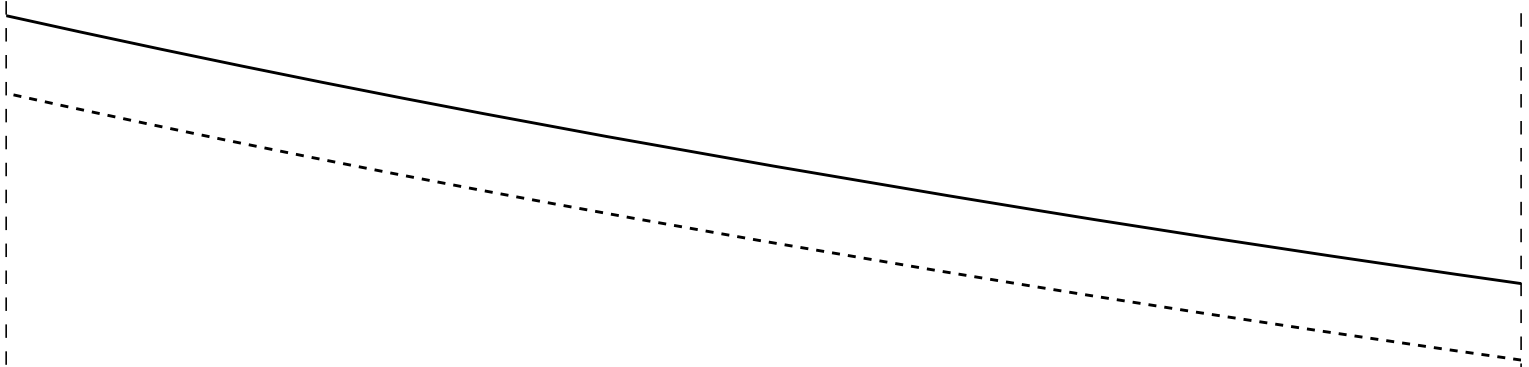

IDDS03

1-5

DOBRA

2-5

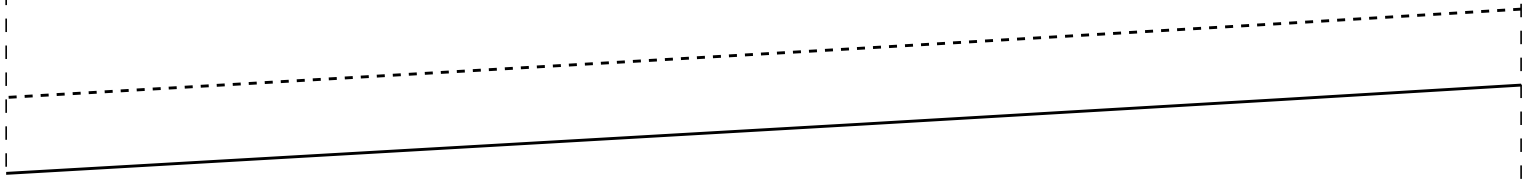

1-6

IDD503

COS 2X
42

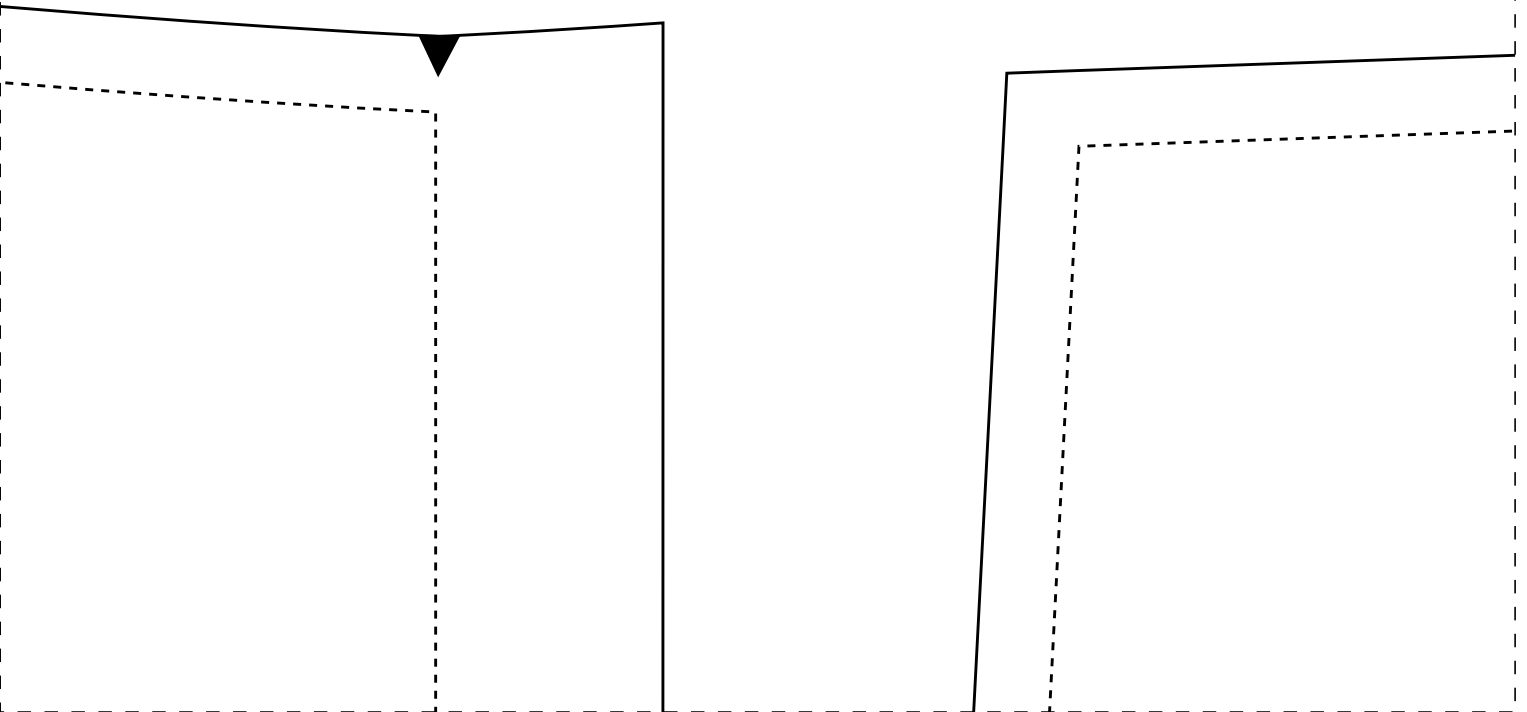

2-6

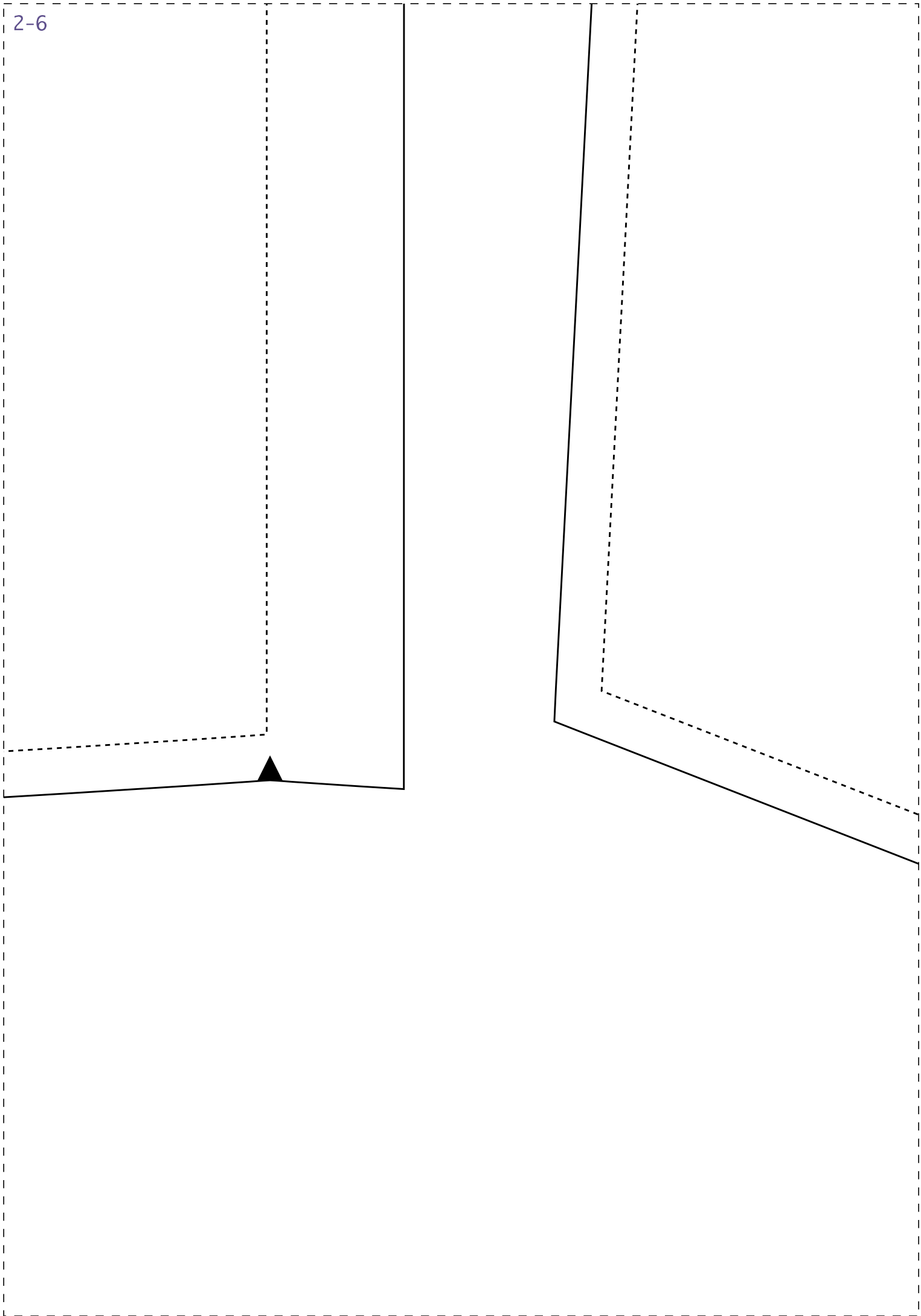

1-7

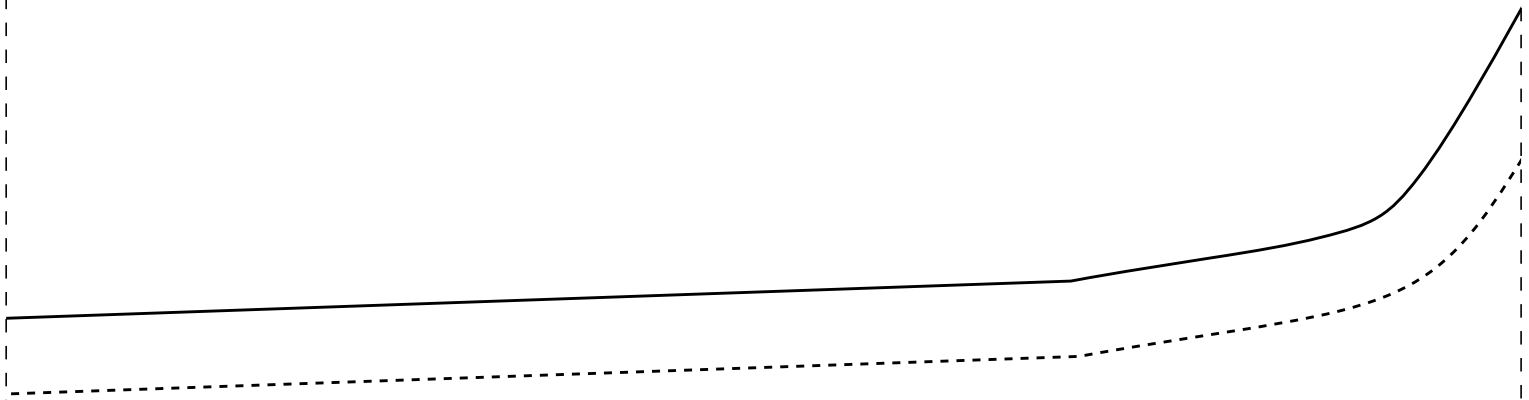
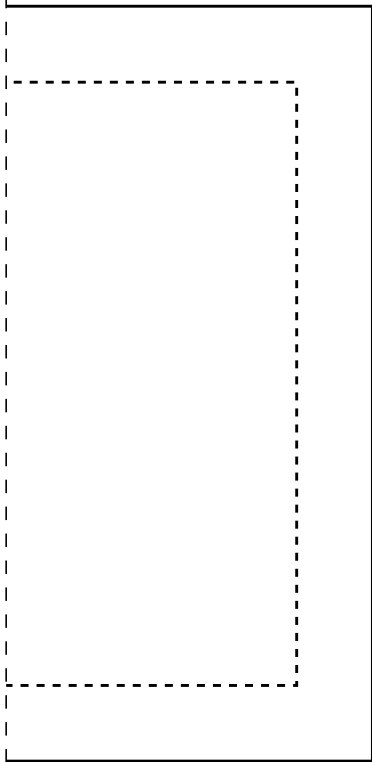

Instituto Diana Demarchi
Curso de Uniformes da Saúde
Calça Pijama Cirúrgico
Feminino

PROIBIDA REVENDA

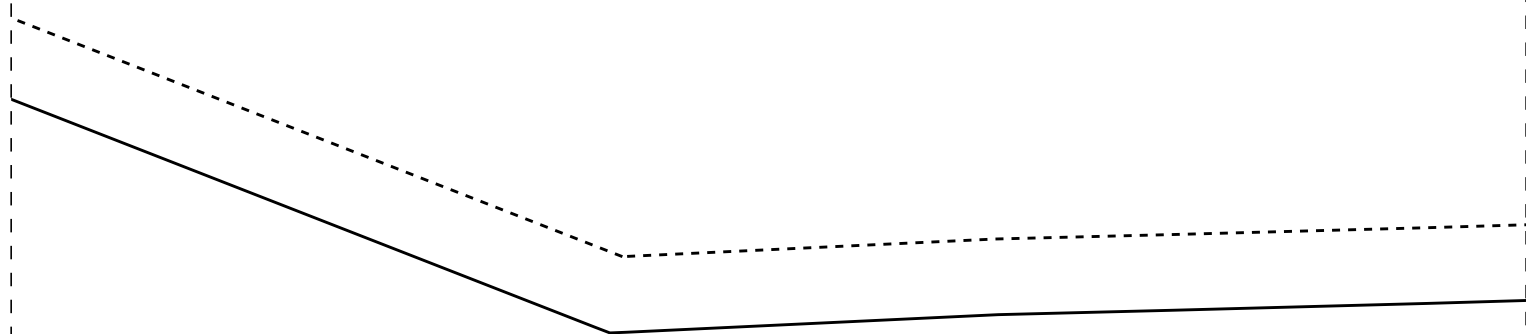

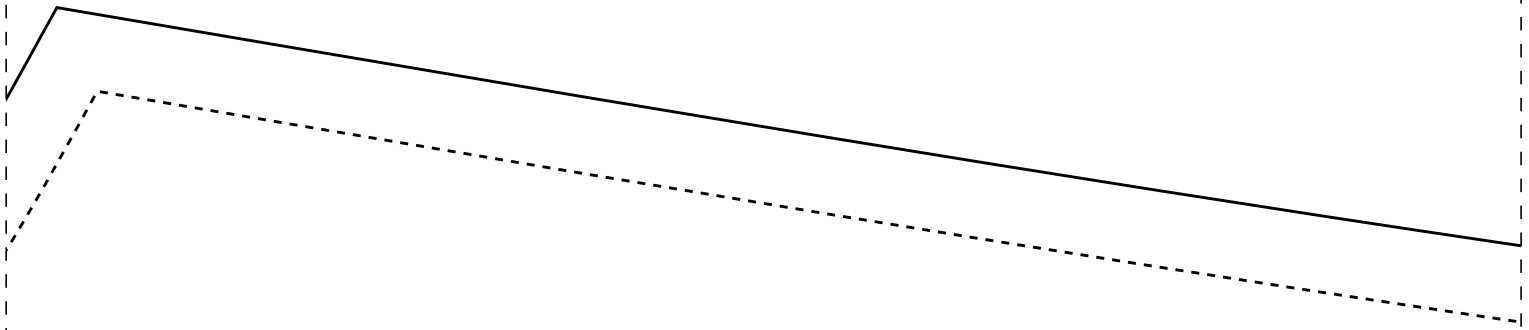

2-8

DIANTEIRO 2X
42

IDDSO

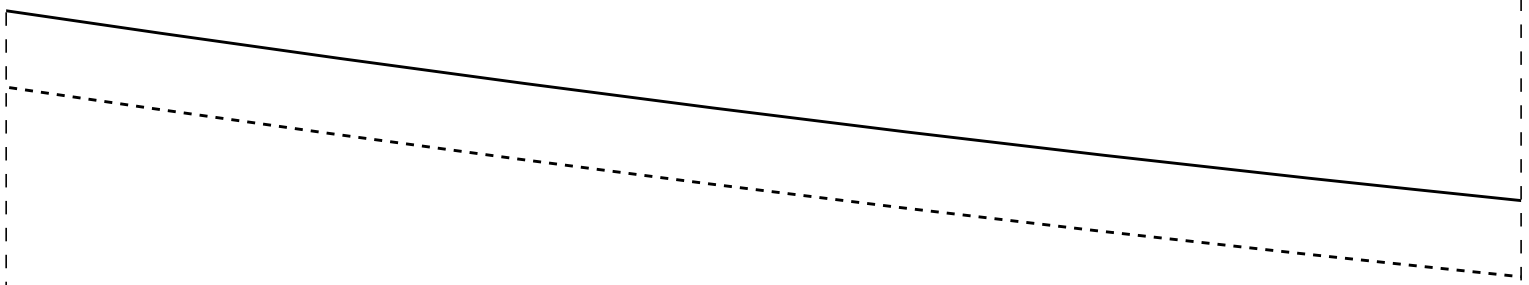

2-9

3

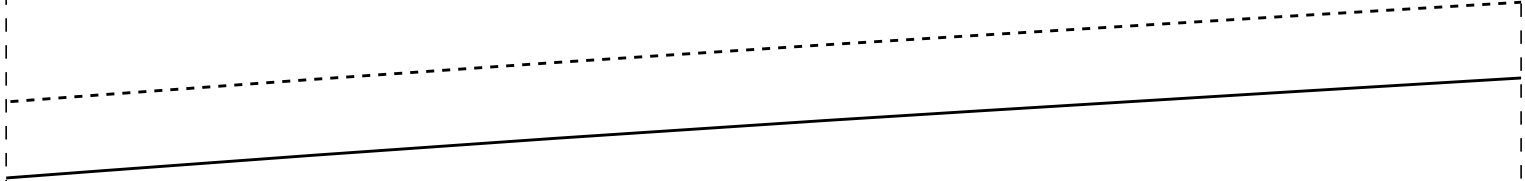

IDD S03

BC

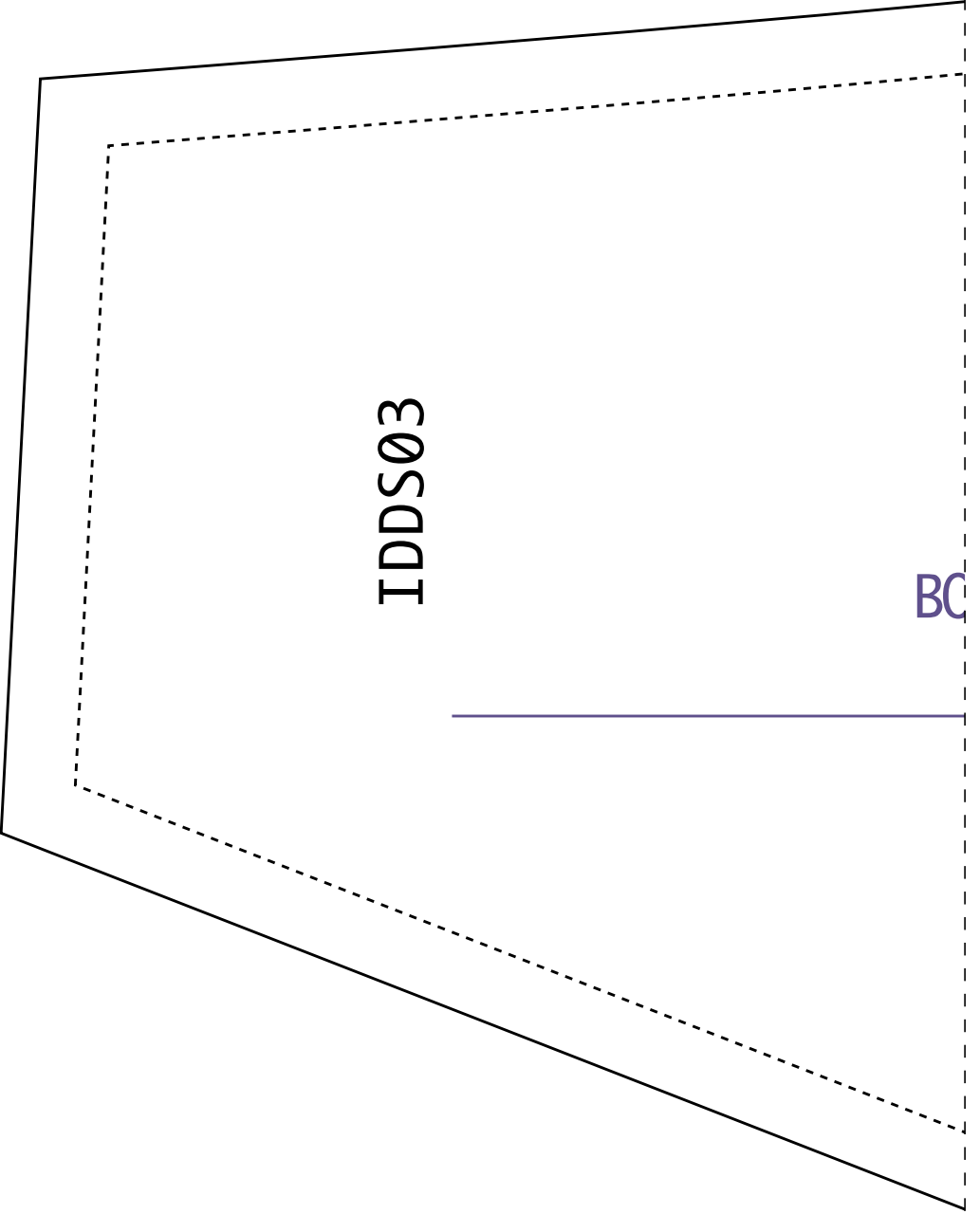

2-10

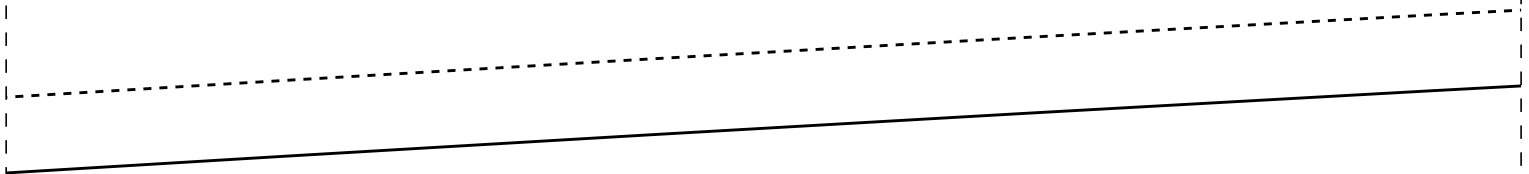

1-11

ALSO 2X
42

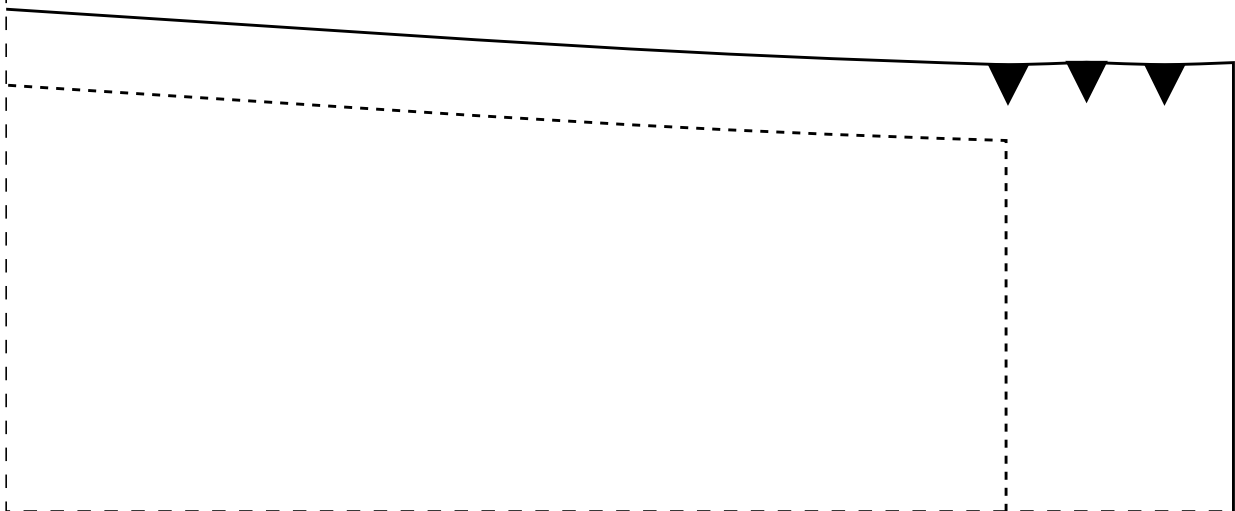
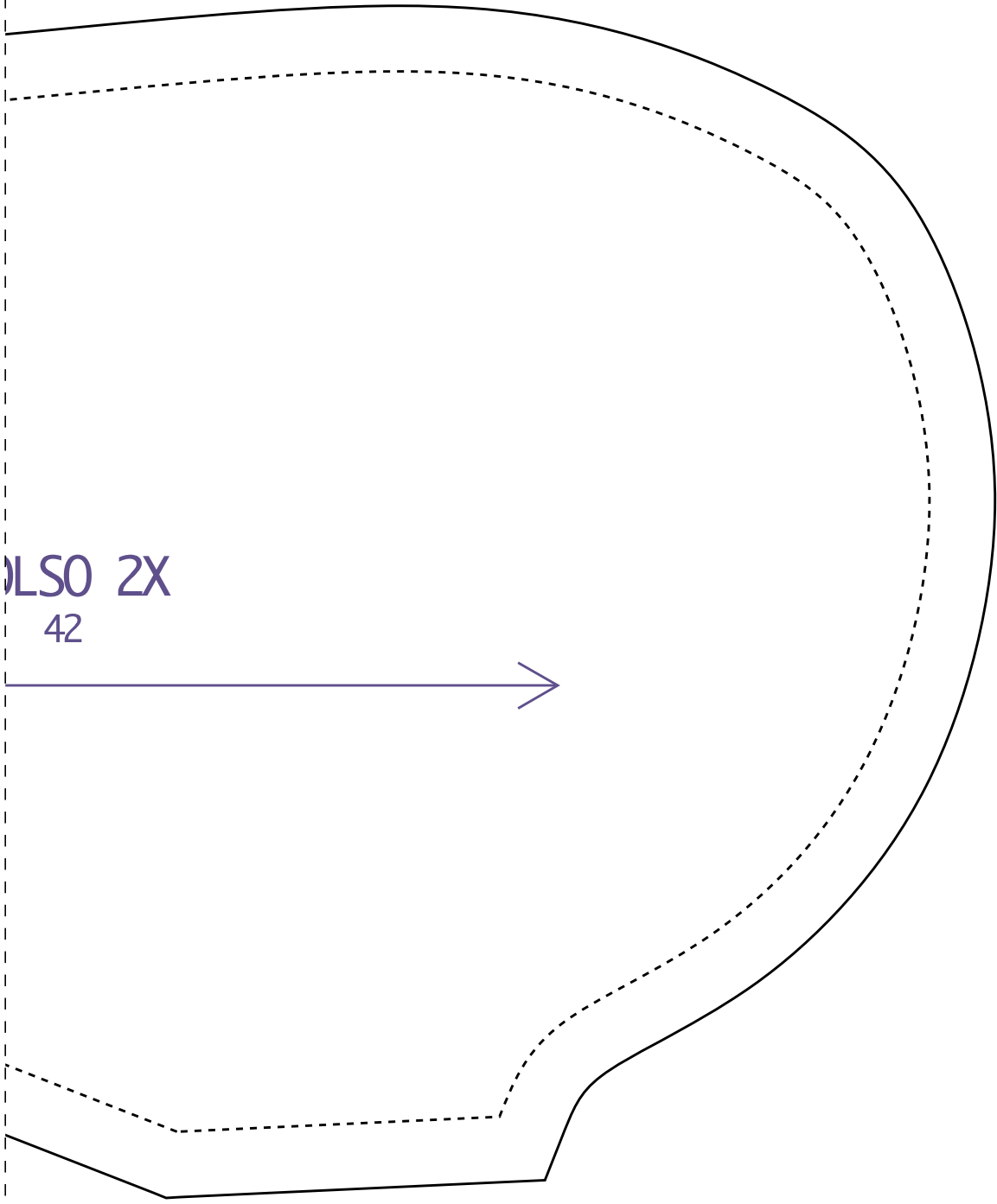

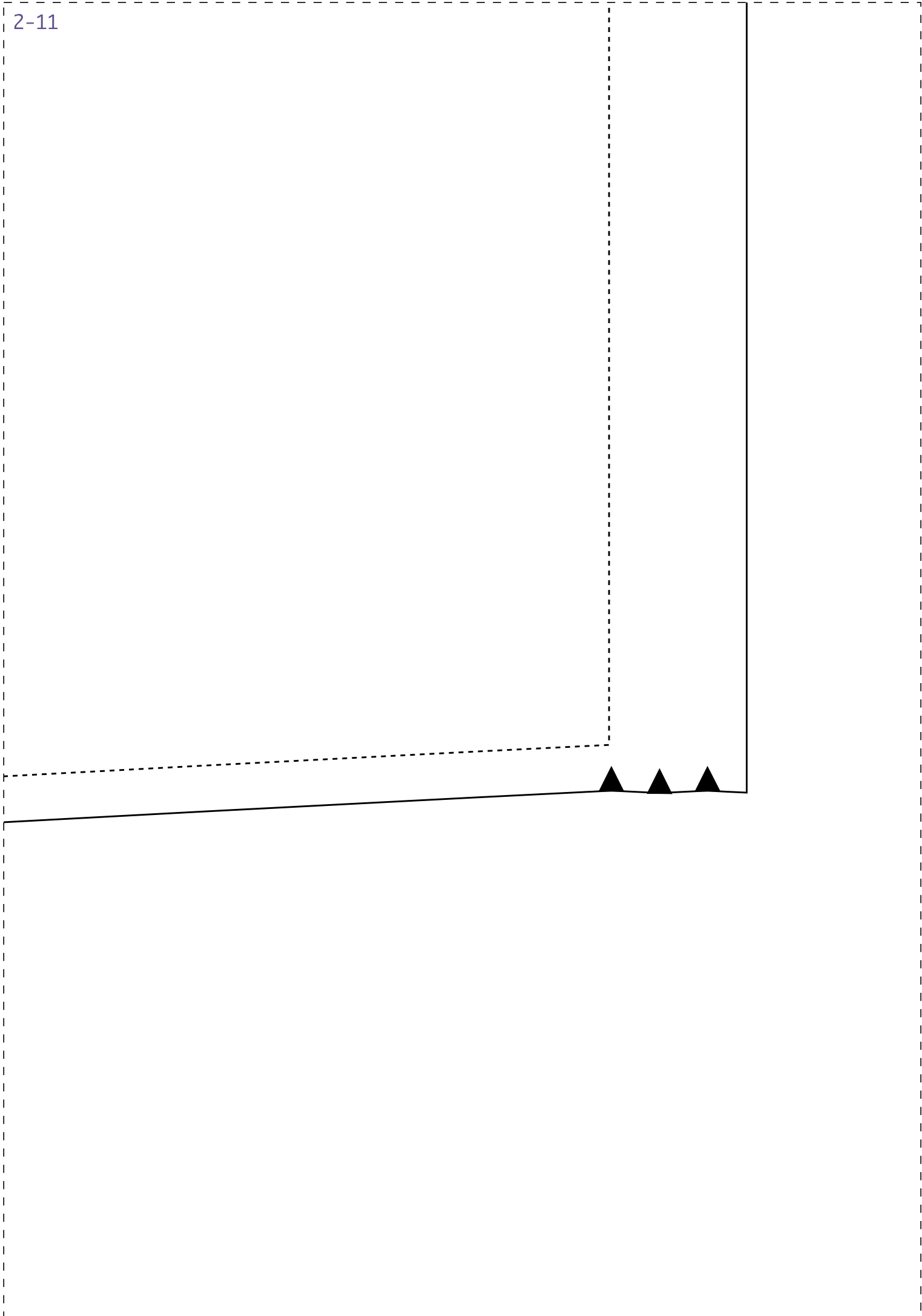

IDDS03

ESP/B



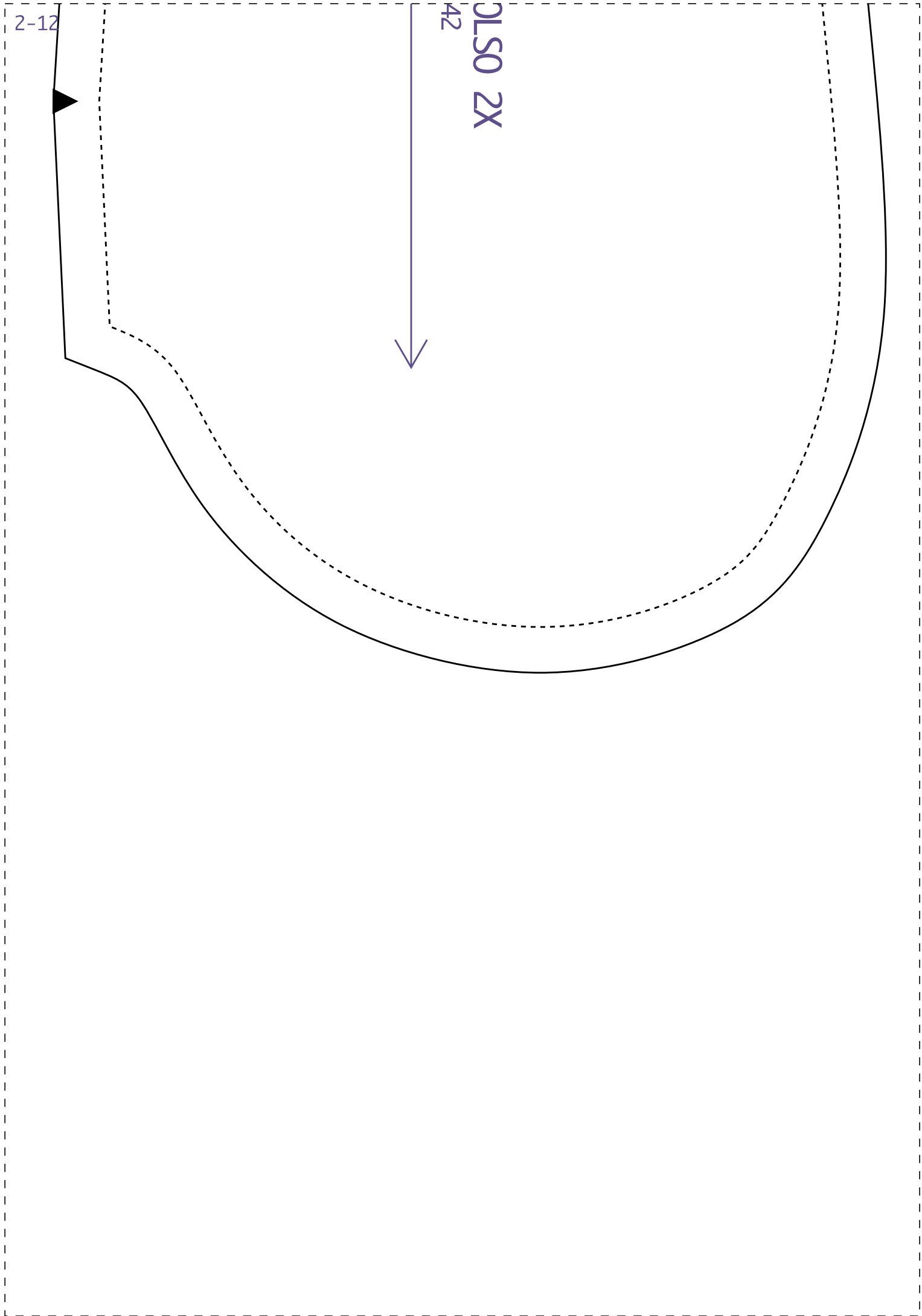

2-12



42

QLSO 2X