

1-1

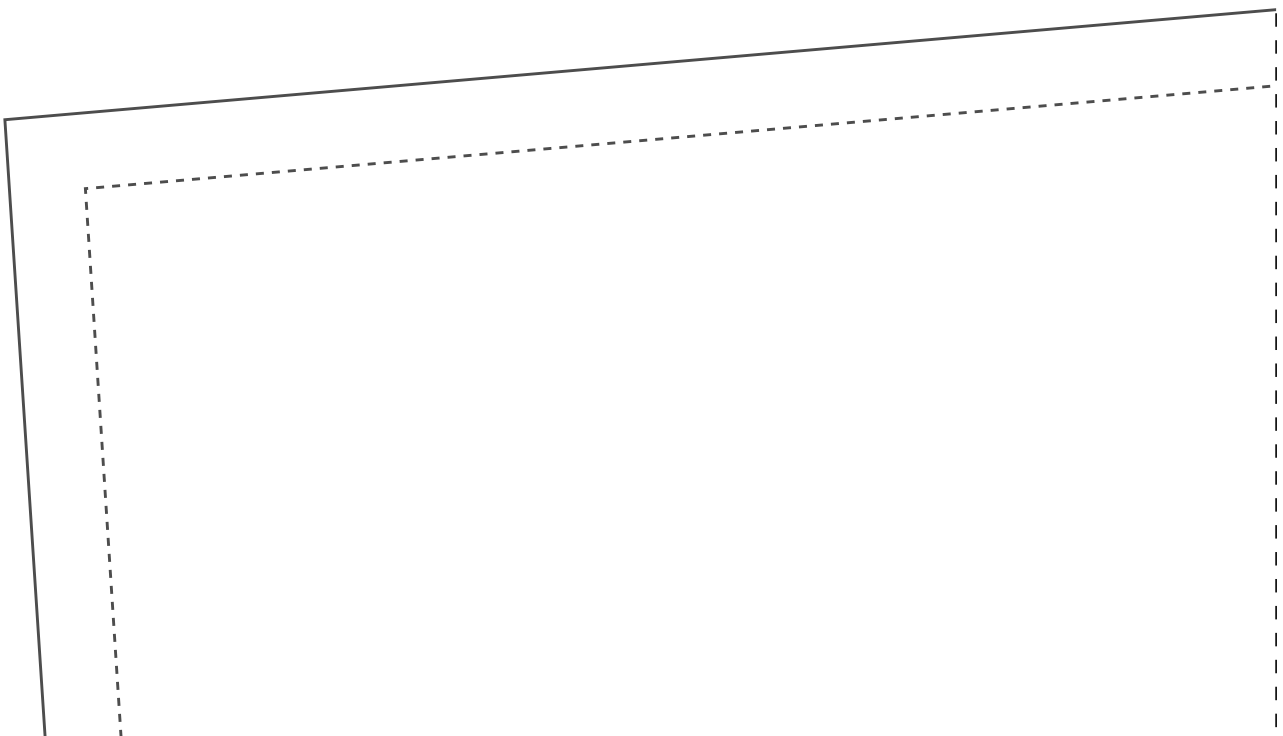

2-1

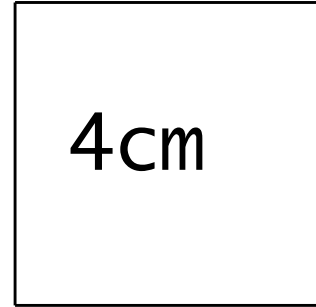
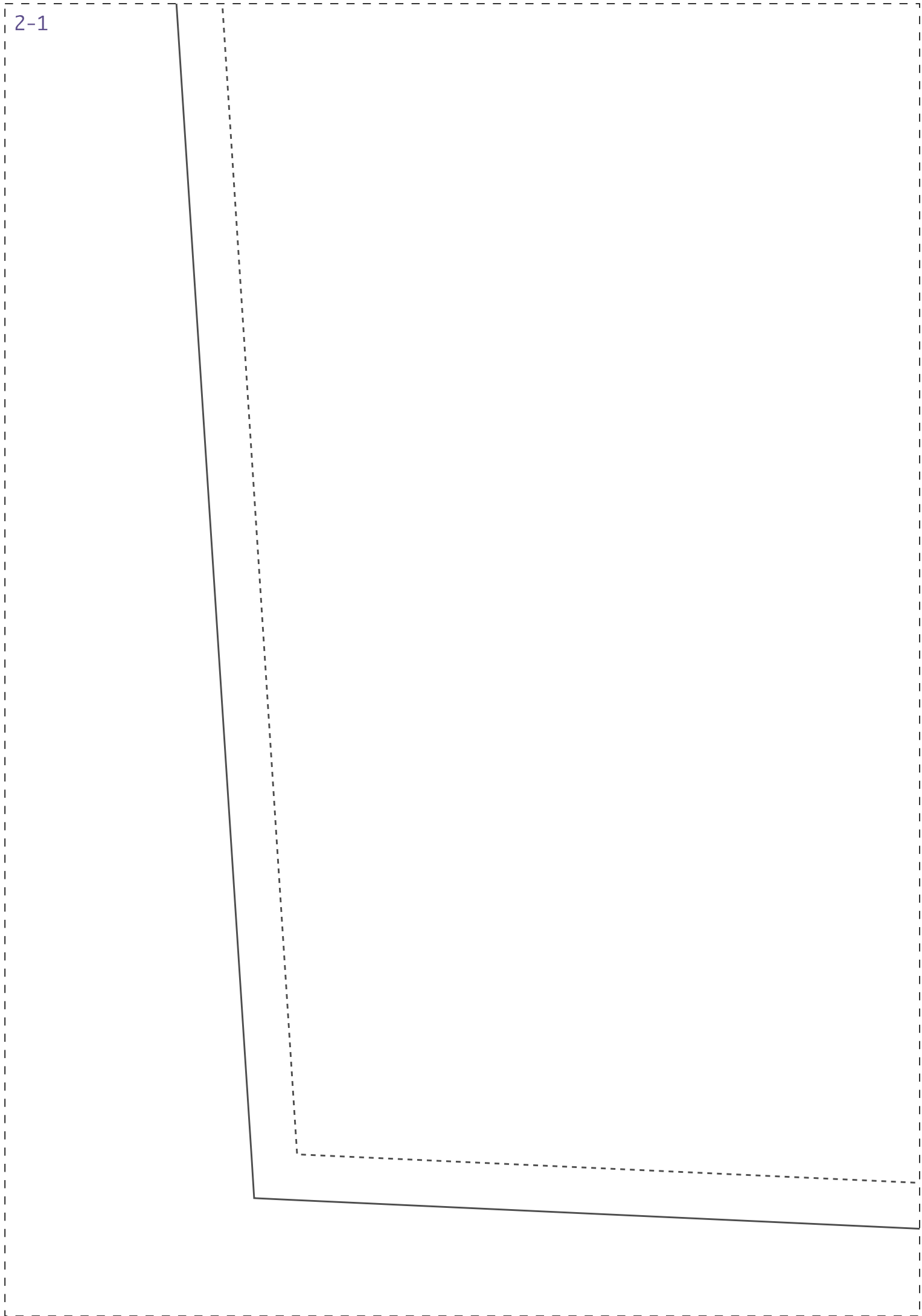

Teste de impressão: ao imprimir seu molde, meça o quadrado que deverá ter a mesma medida informada (4cm), assim você se certificará que ele foi impresso no tamanho correto.

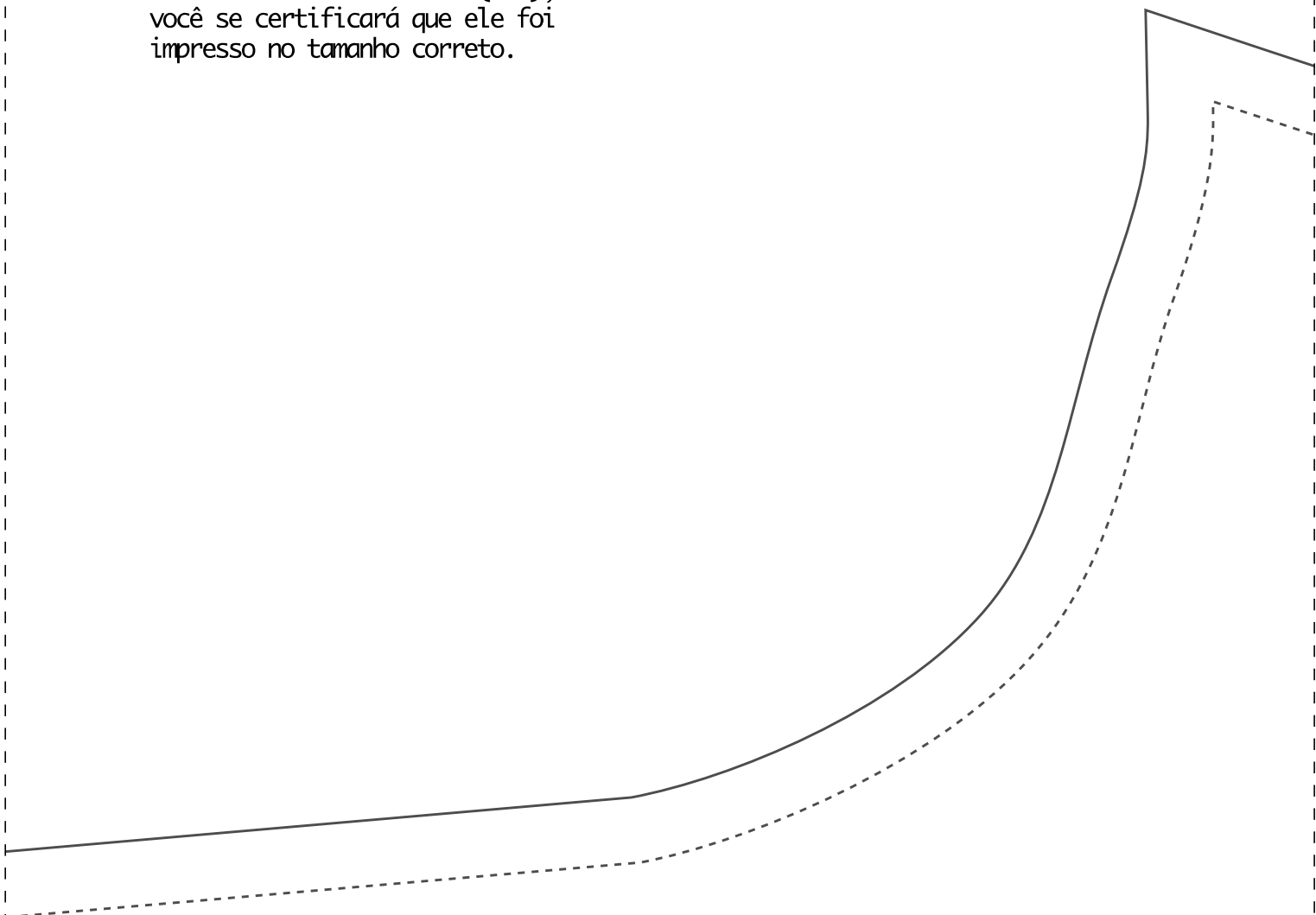

## FICHA TÉCNICA:

Tecido Plano 1,4m larg

-Crepe Flow, Oxfordine,

Gabardine, brim leve ou similares

-Cós com elástico 4cm,

cortar elástico com:

36: 72cm / 38: 74cm / 40: 76cm

42: 78cm / 44: 80cm / 46: 82cm

48: 84cm / 50: 86cm / 52: 88cm

54: 90cm

-2,3m do 36 ao 44

-2,5m do 46 ao 54

1-3

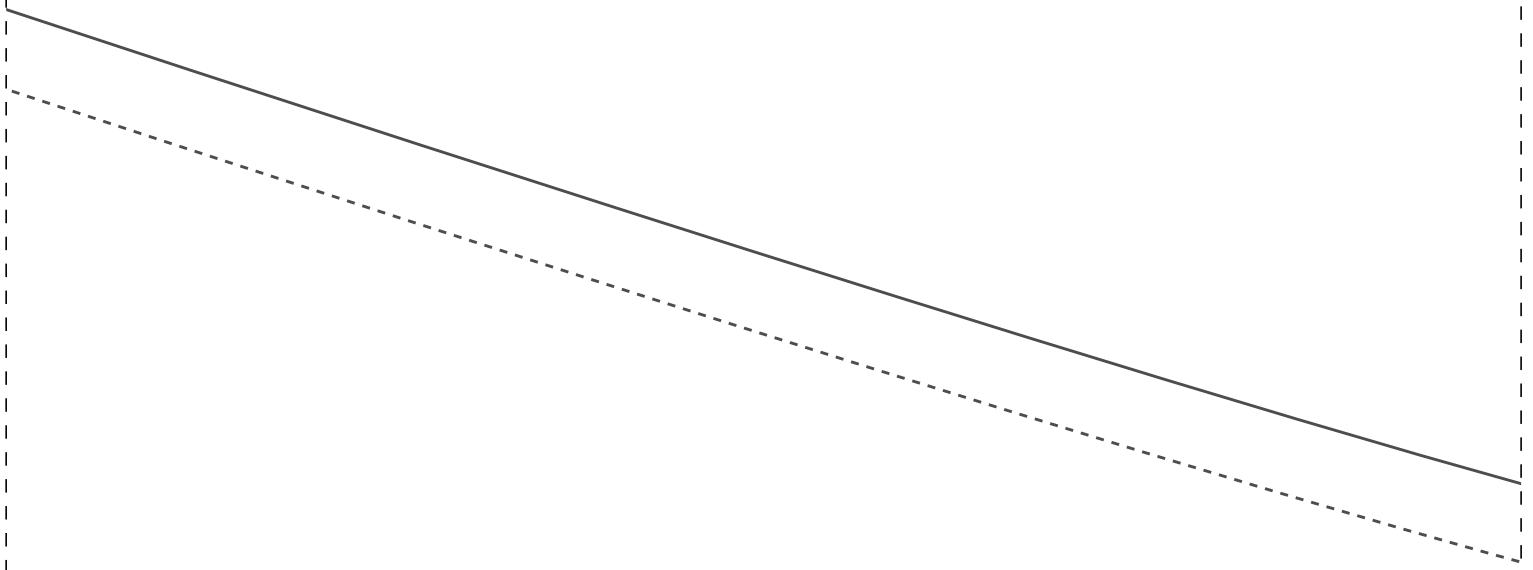

---

TRASEIRO 2X  
50

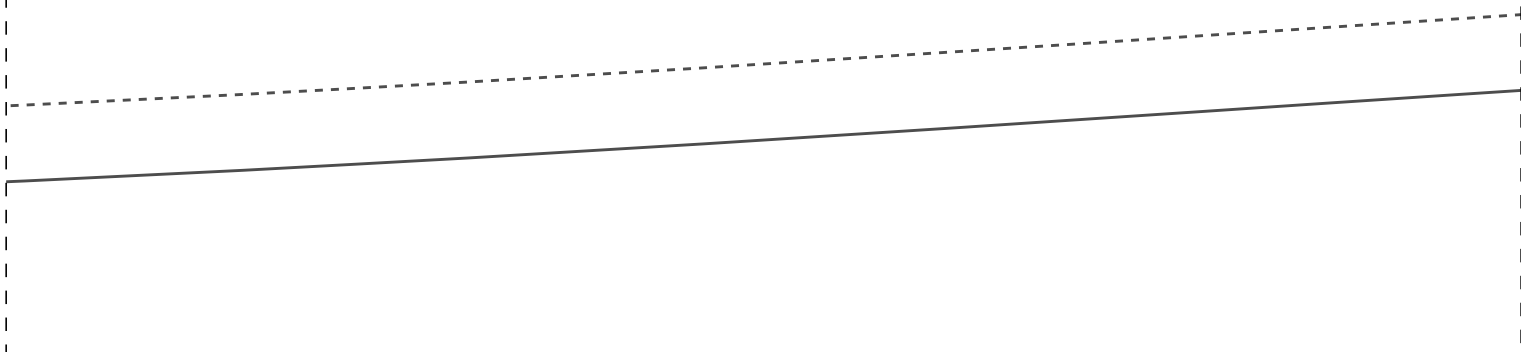

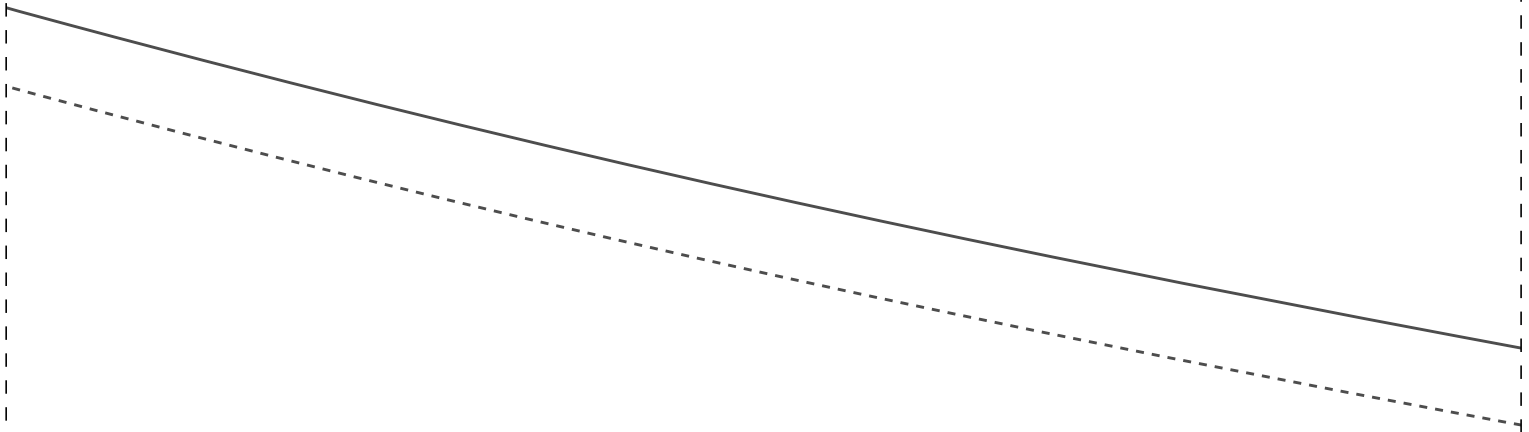

IDDS03



DOBRA

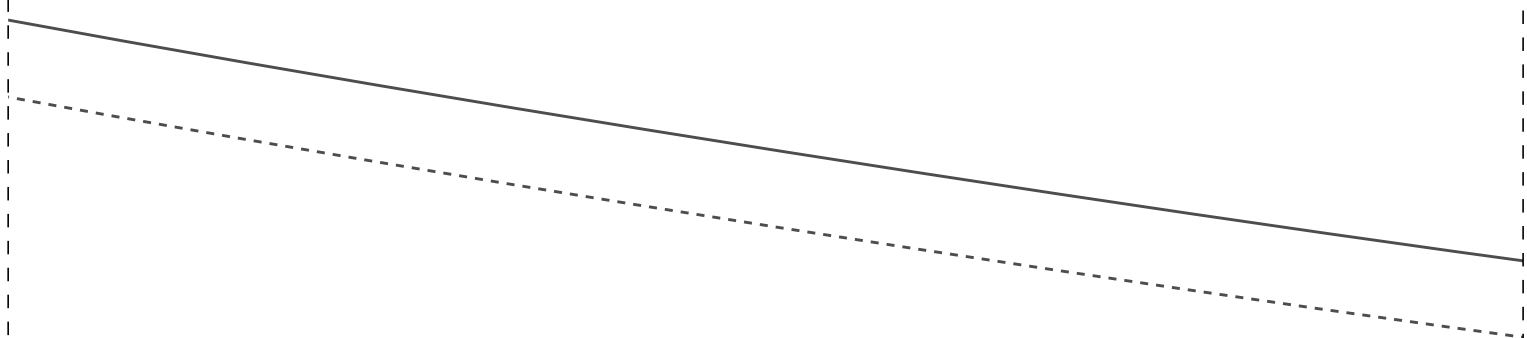

2-5



1-6

IDD503

CÓ5 2X  
50

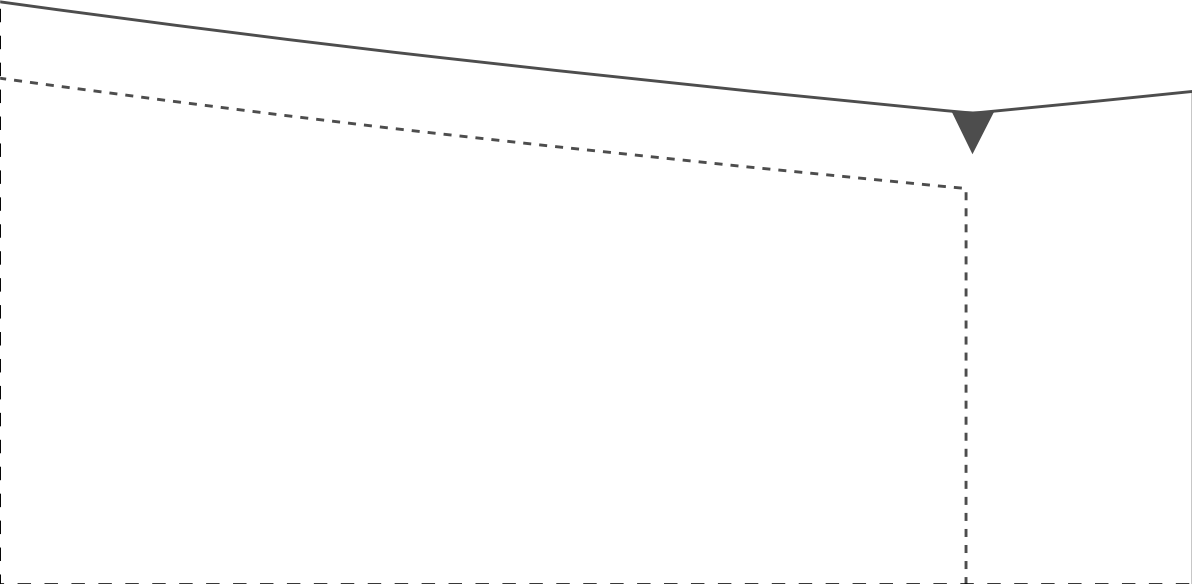

2-6

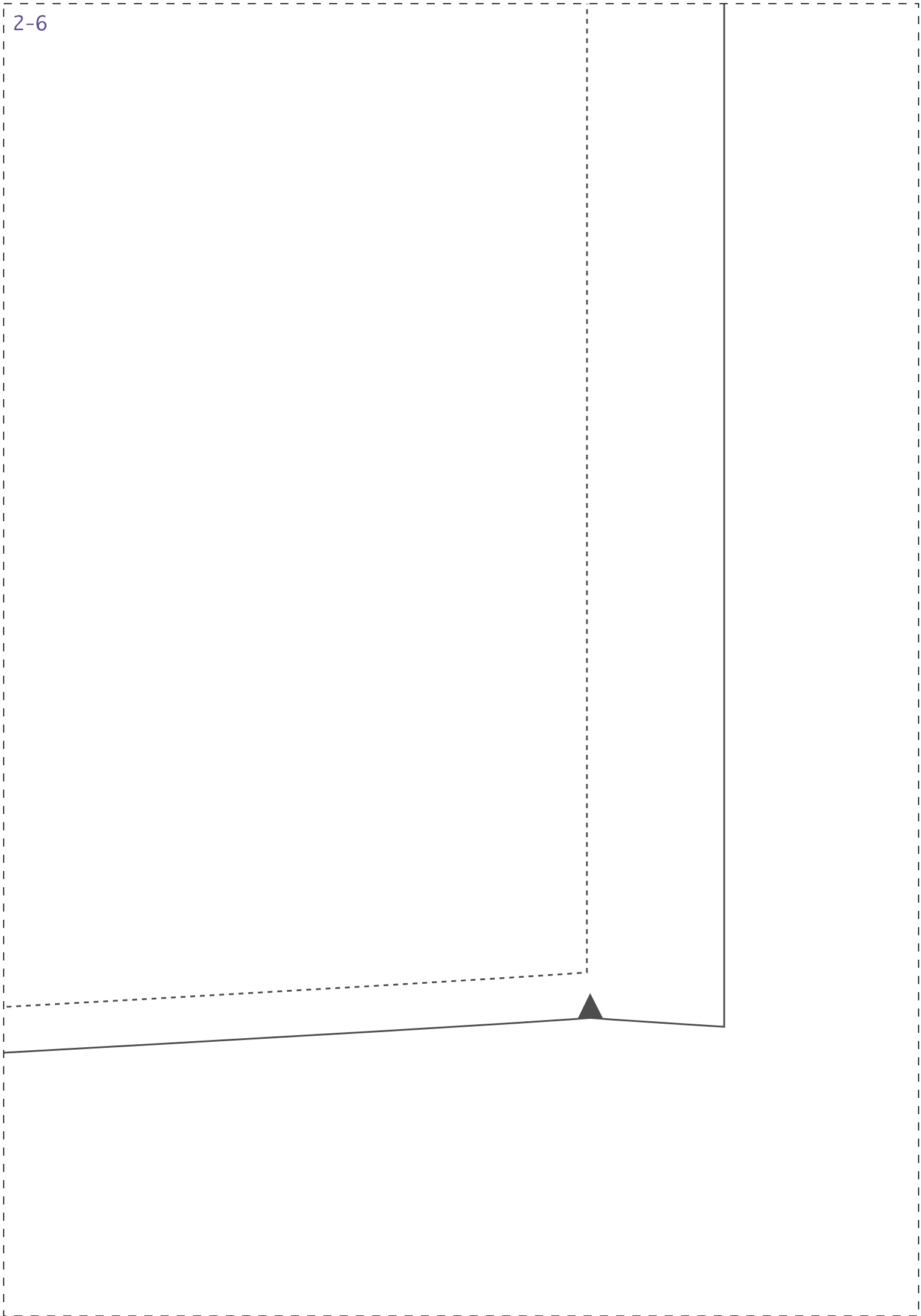

1-7

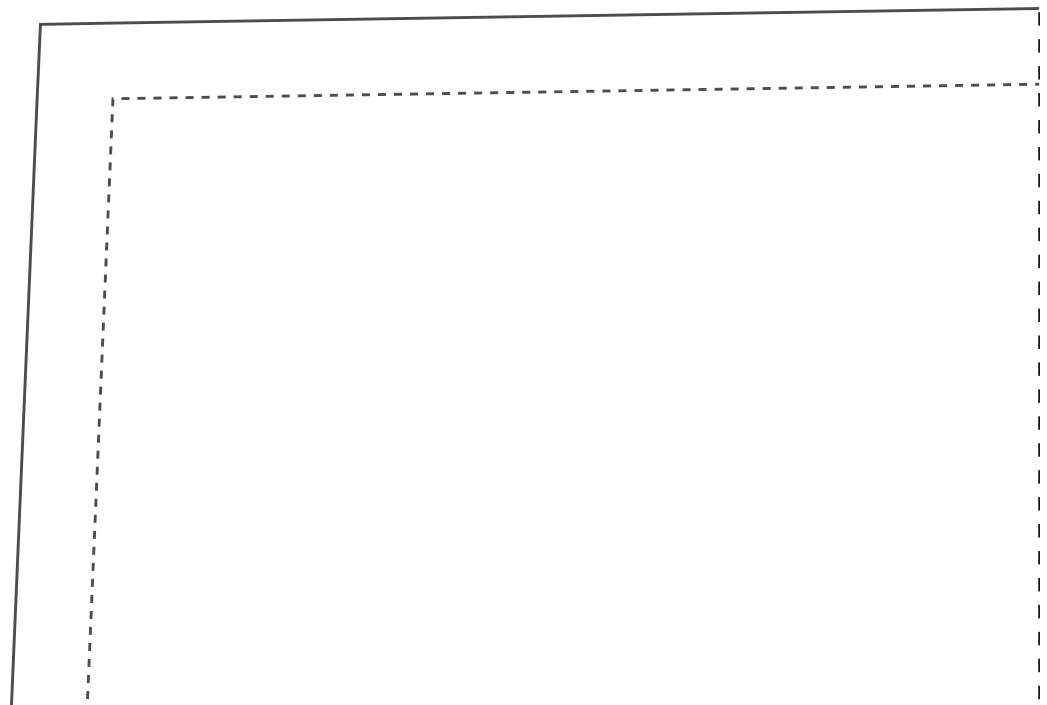
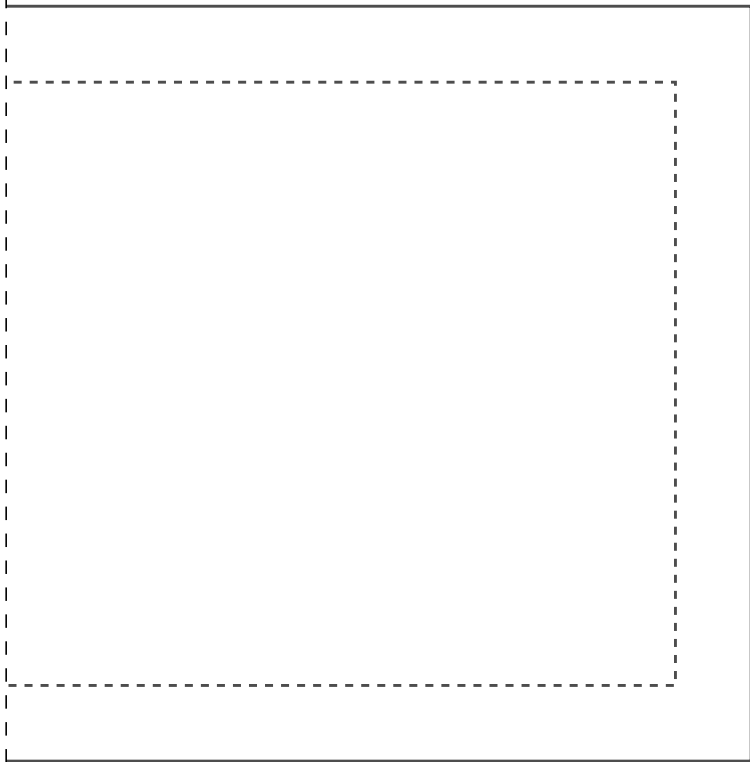

2-7

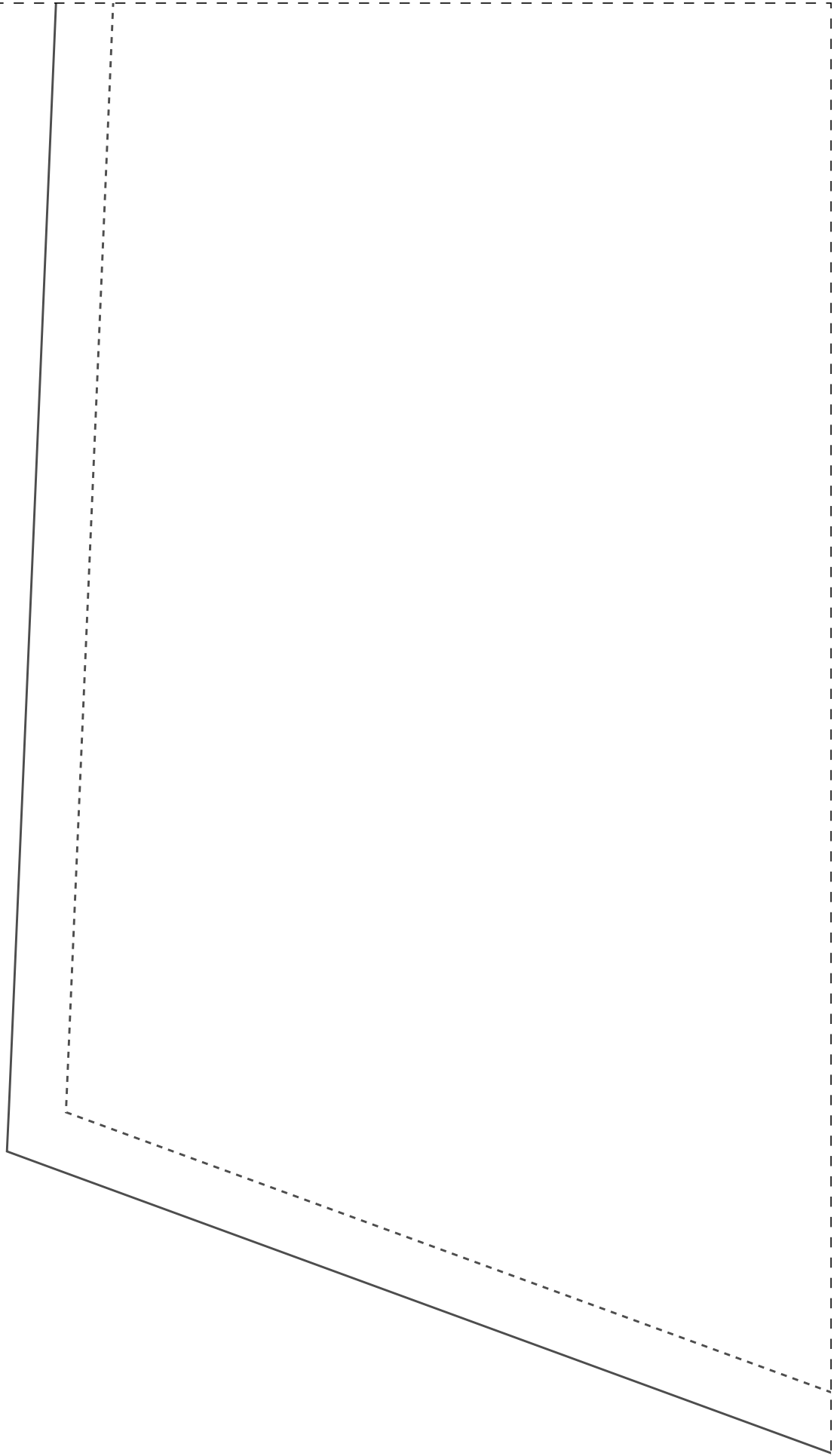



---

Instituto Diana Demarchi  
Curso de Uniformes da Saúde  
Calça Pijama Cirúrgico  
Feminino

**PROIBIDA REVENDA**



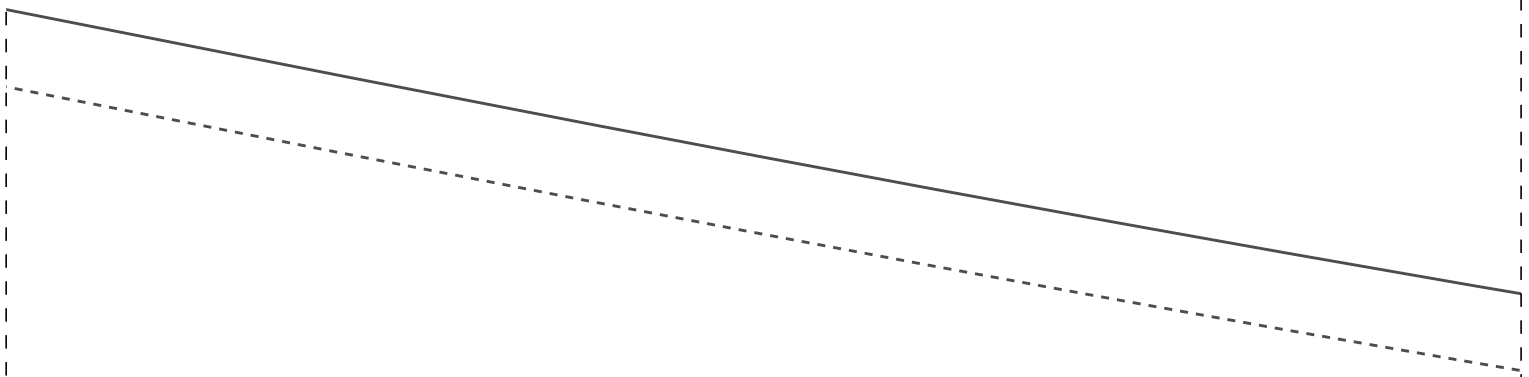

DIANTEIRO 2X  
50

---

IDDS03



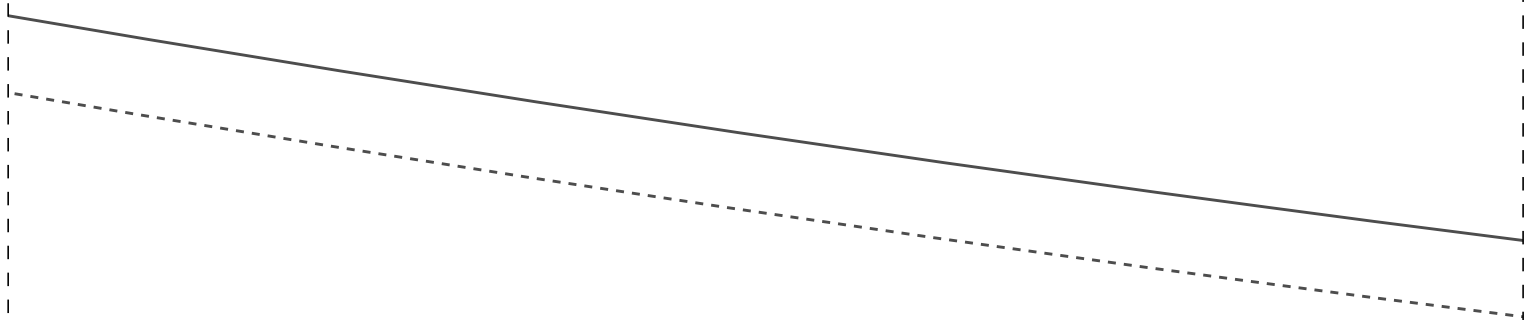

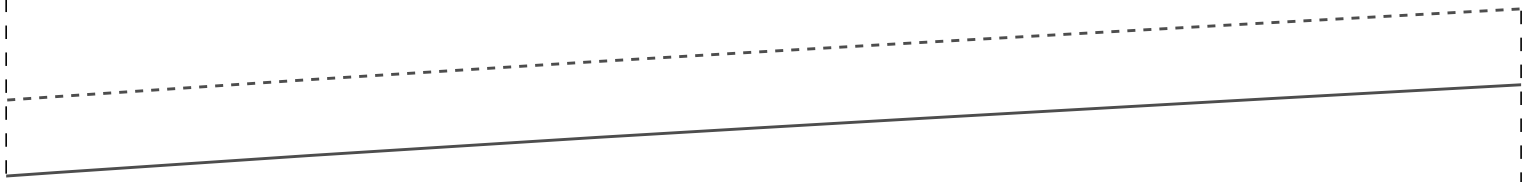

IDD SØ3

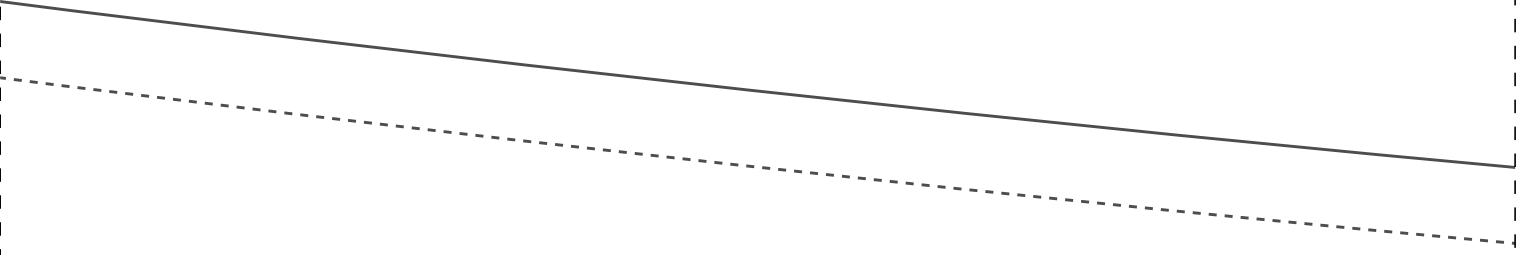
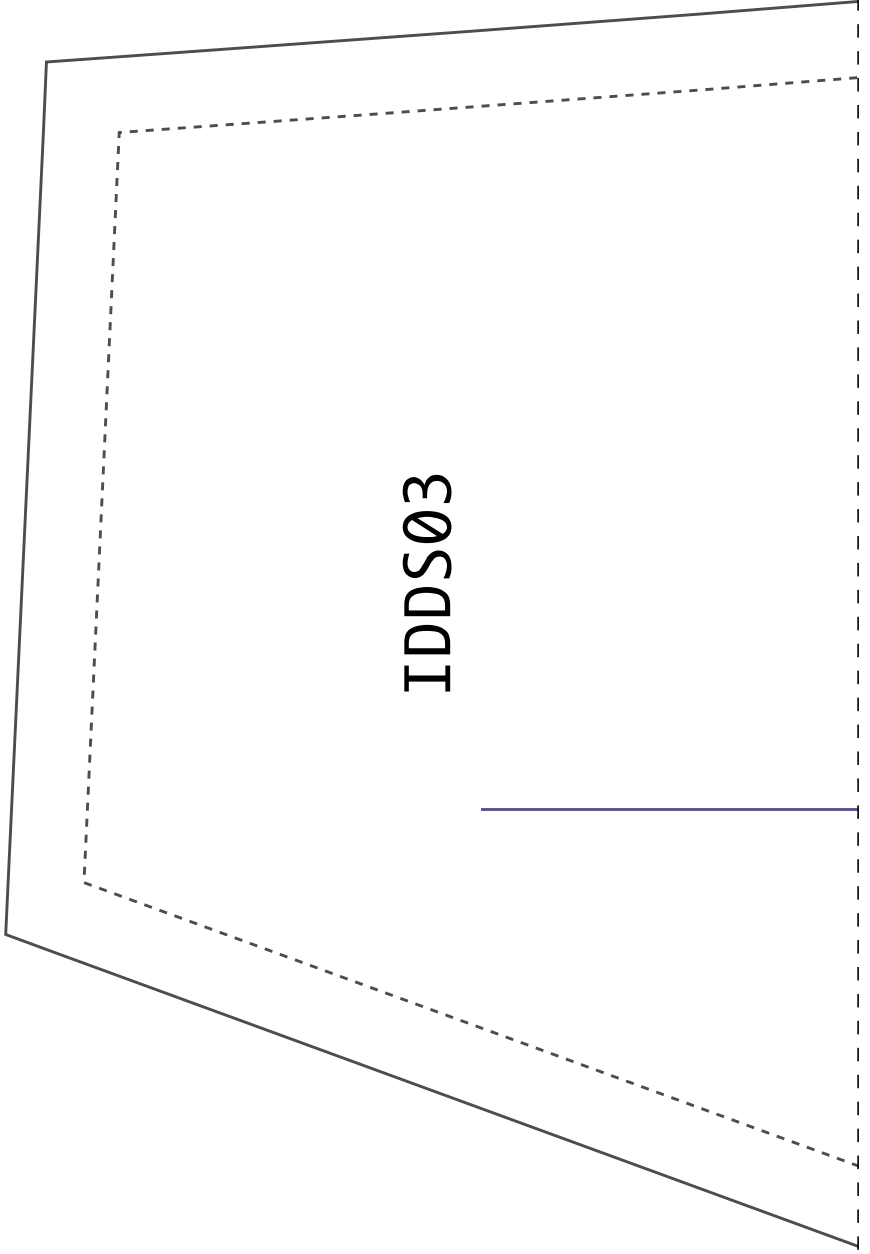

2-11

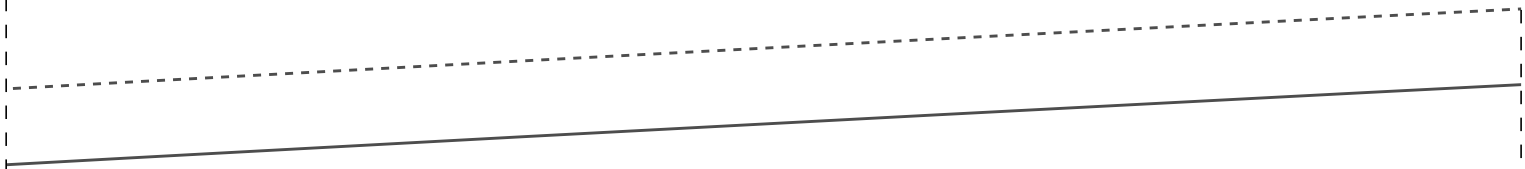

1-12

BOLSO 2X  
50

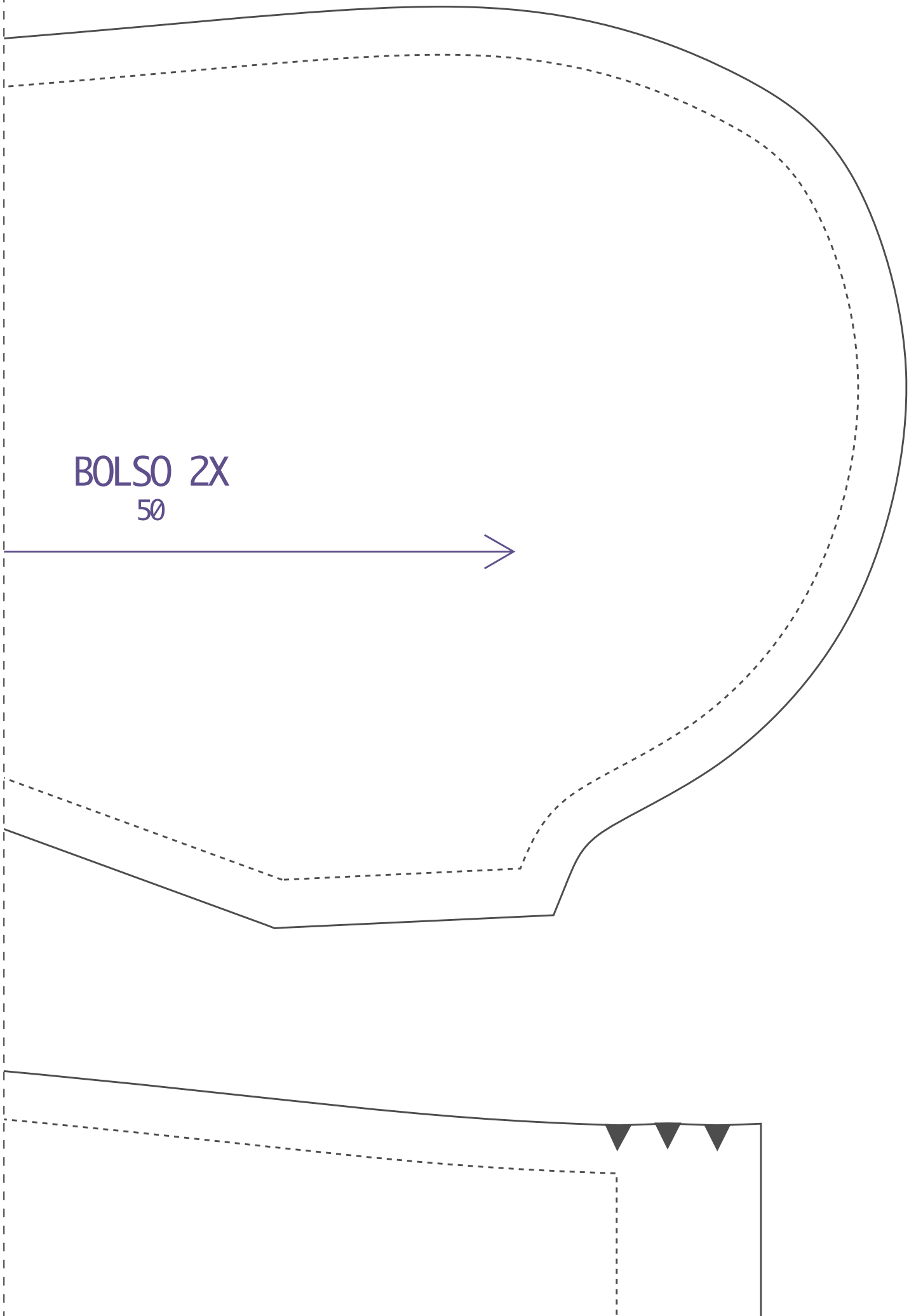

2-12

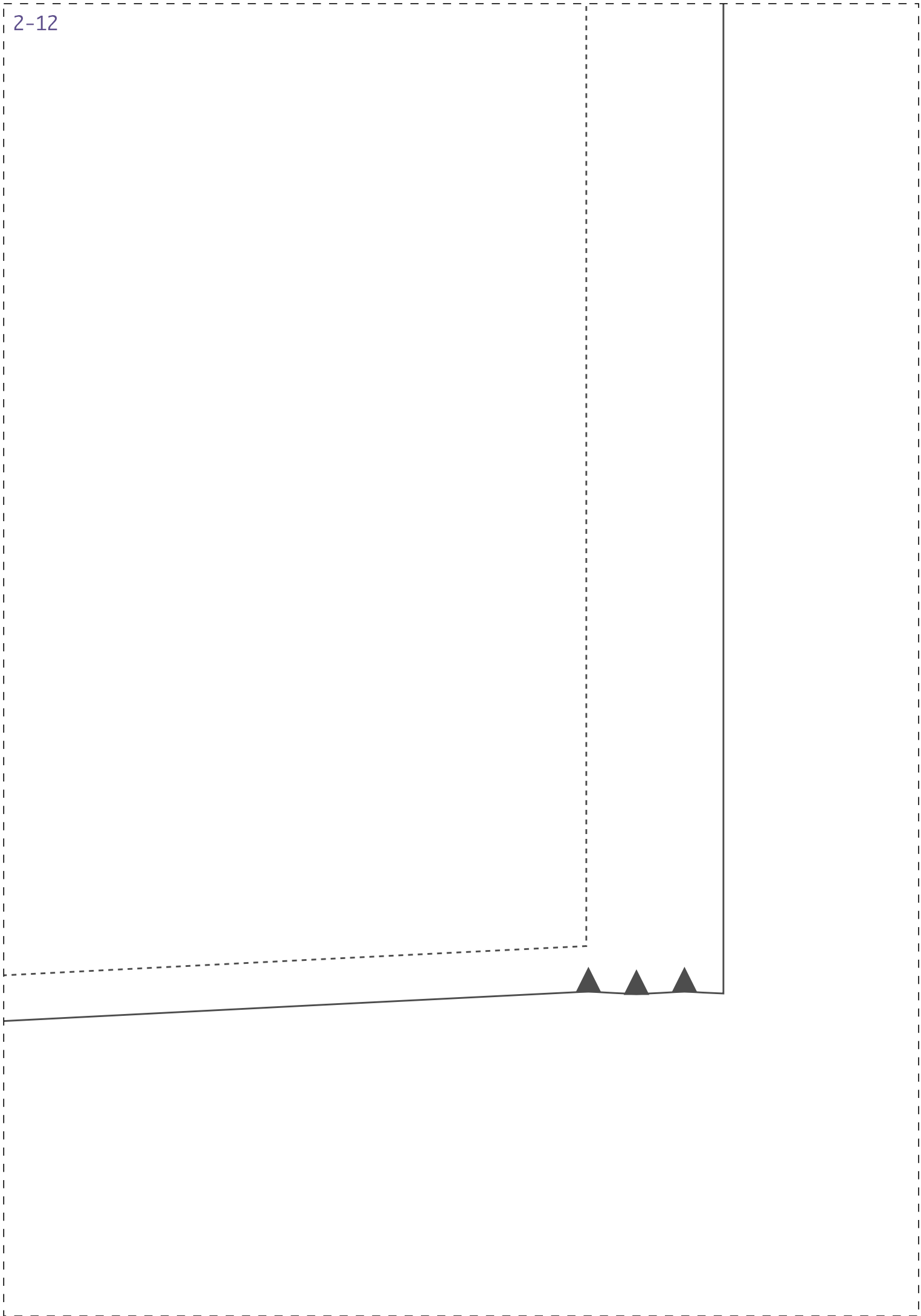



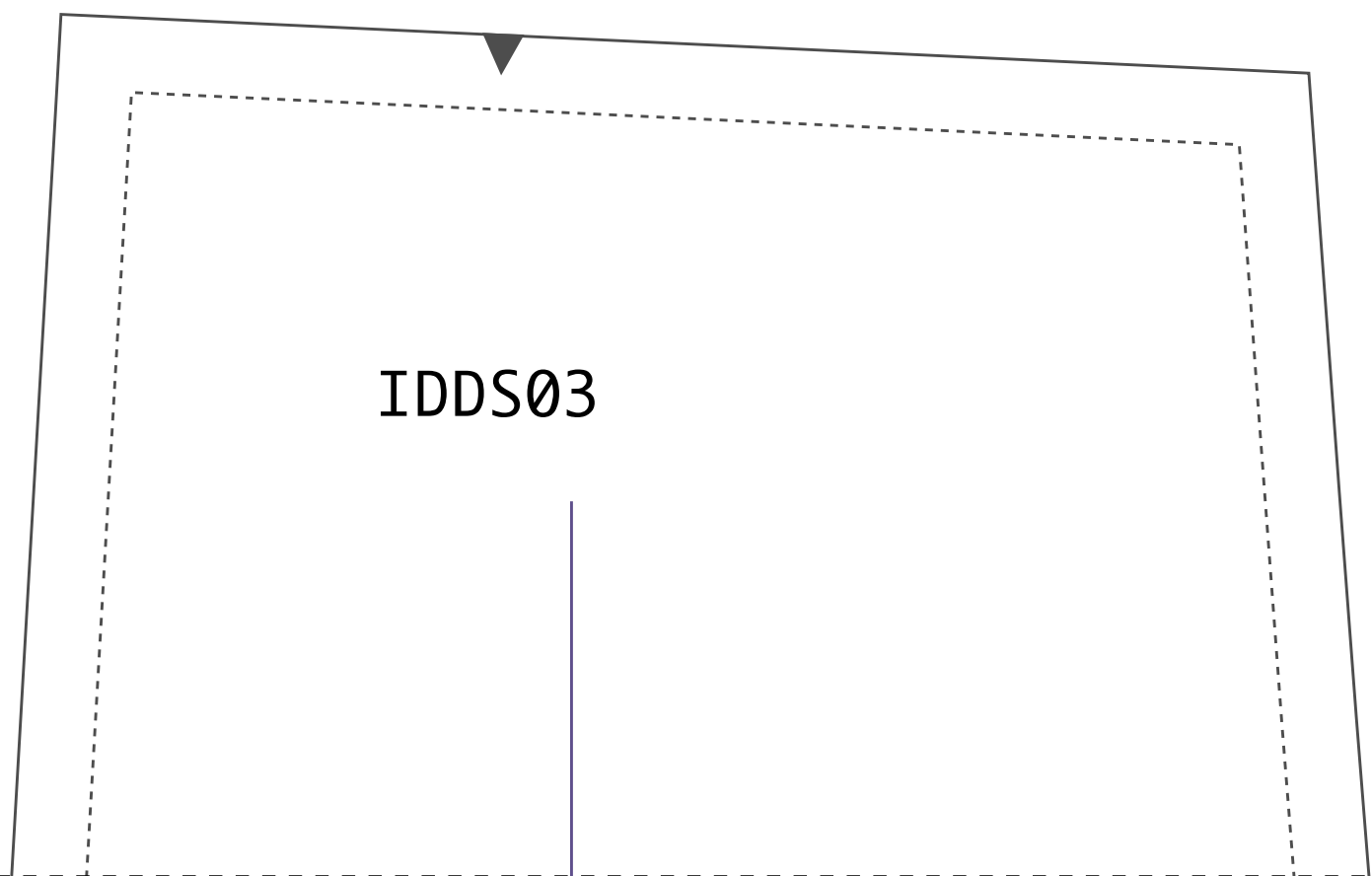

IDDS03

ESP/BOLSO 2X  
50



2-13

