

1-1

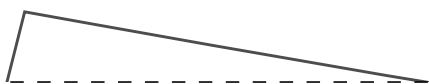

2-1

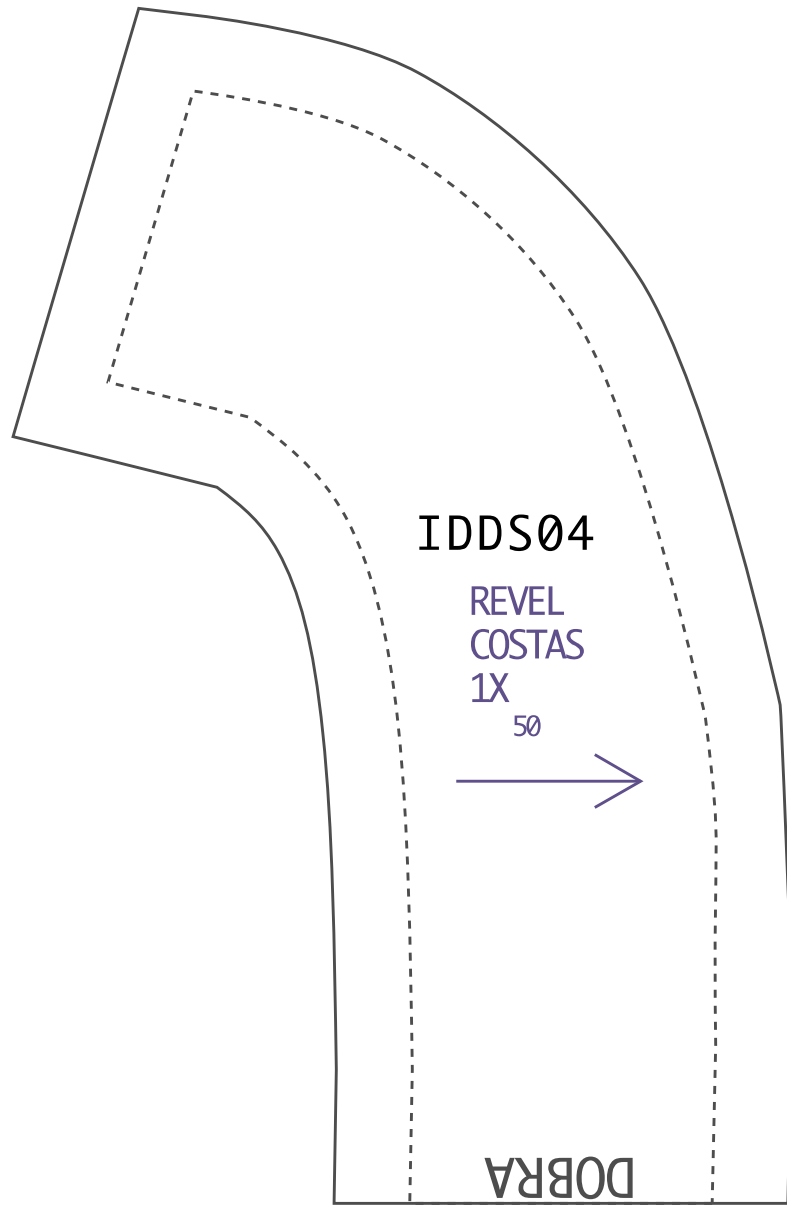

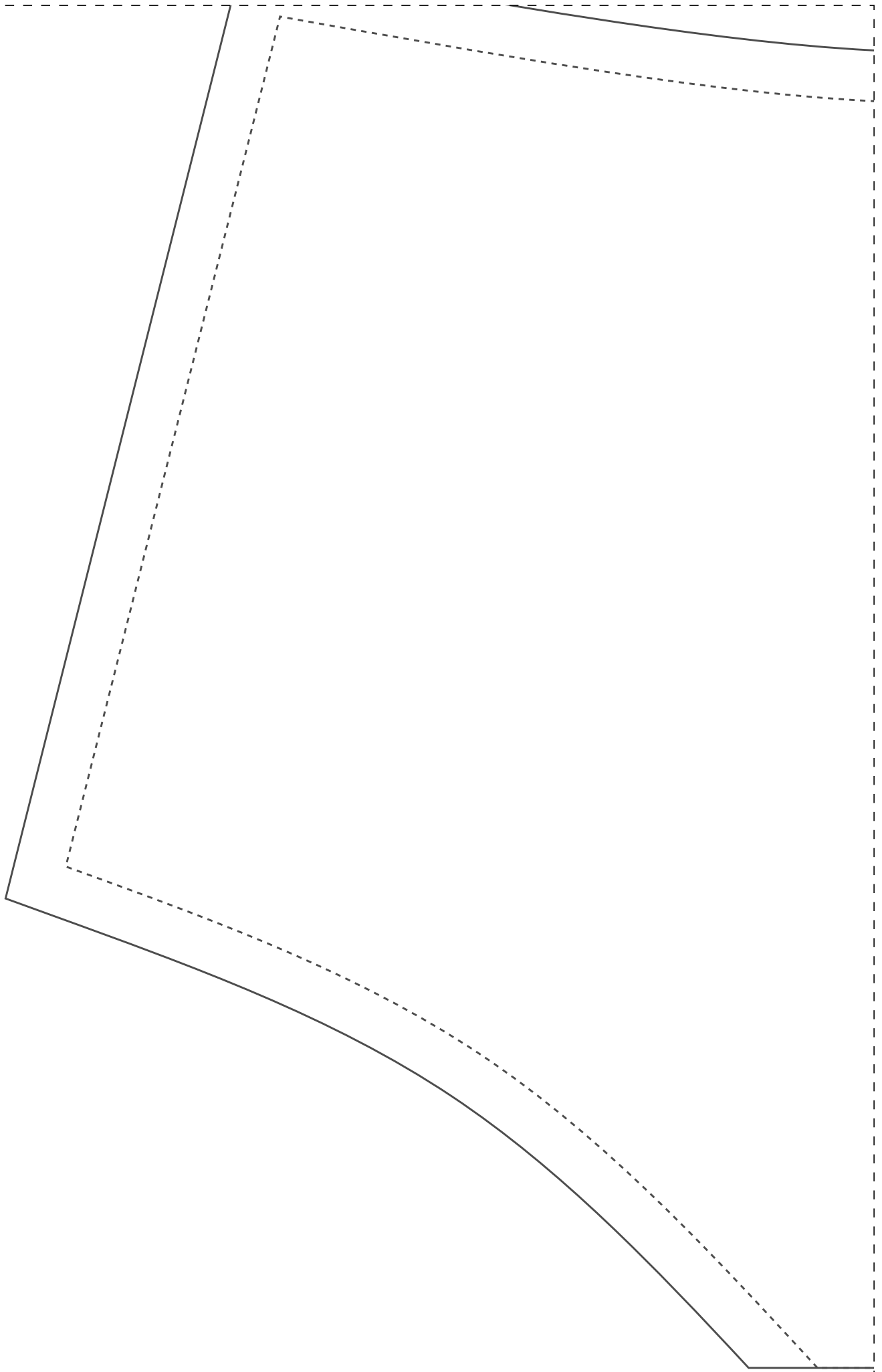
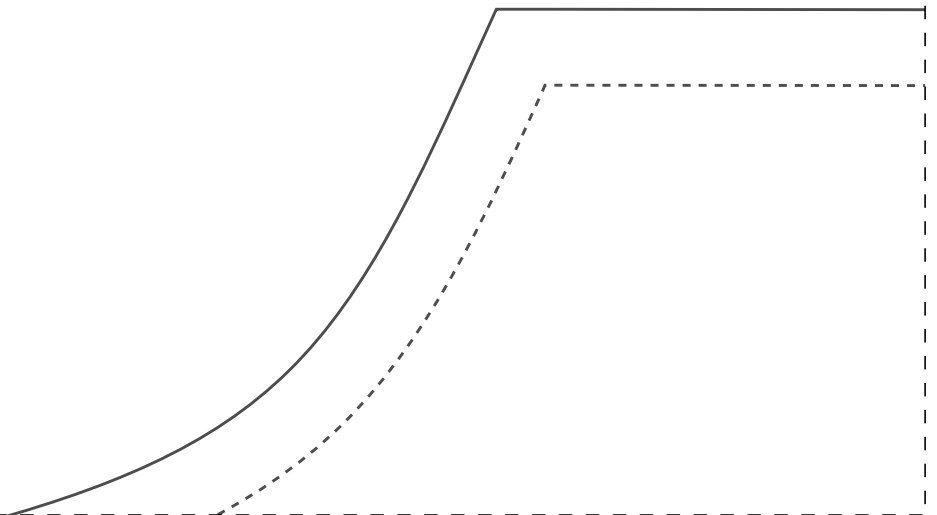
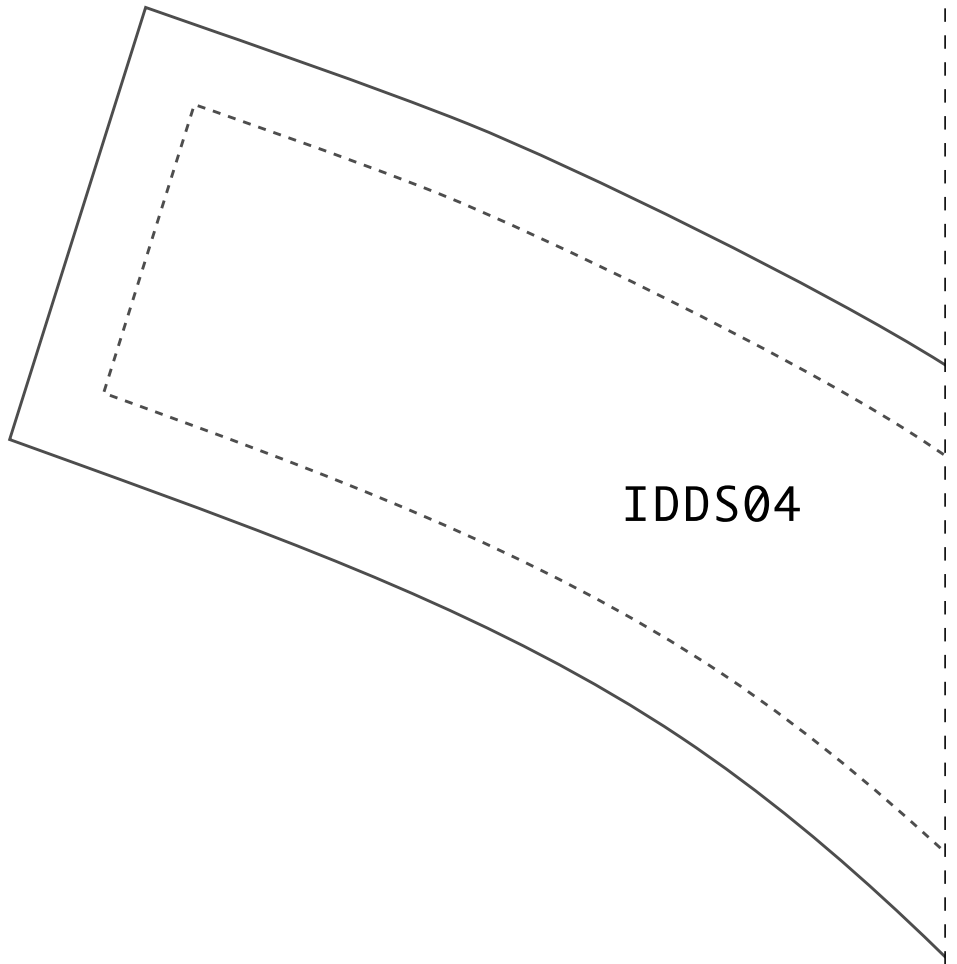

Instituto Diana Demarchi  
Curso de Uniformes da Saúde  
Blusa Pijama Cirúrgico  
Masculino

**PROIBIDA REVENDA**

1-3

REVEL  
FRENTE  
1X  
50

DOBRA 

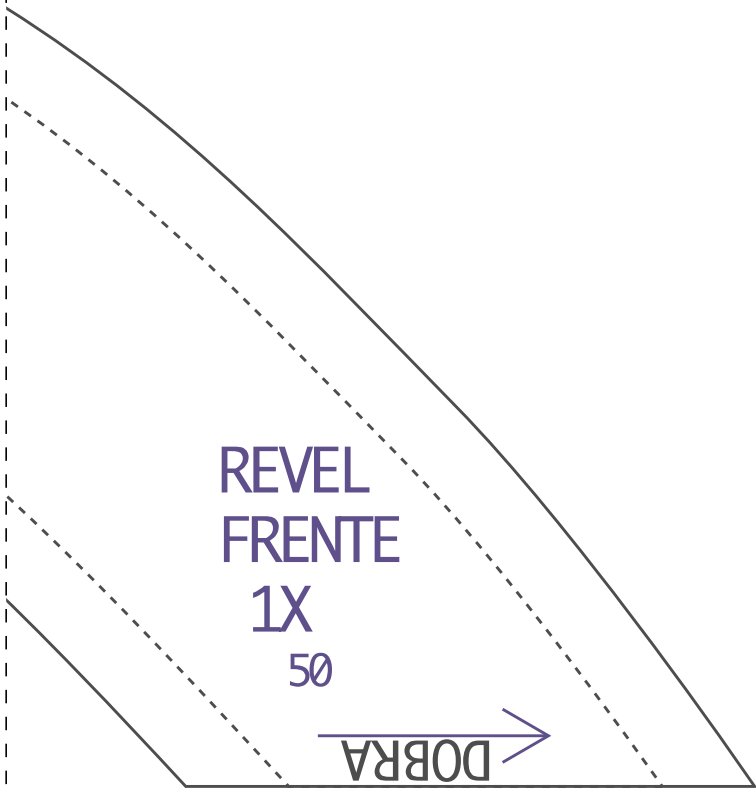

BOLSO

FRENTE 1X  
50

DOBRA

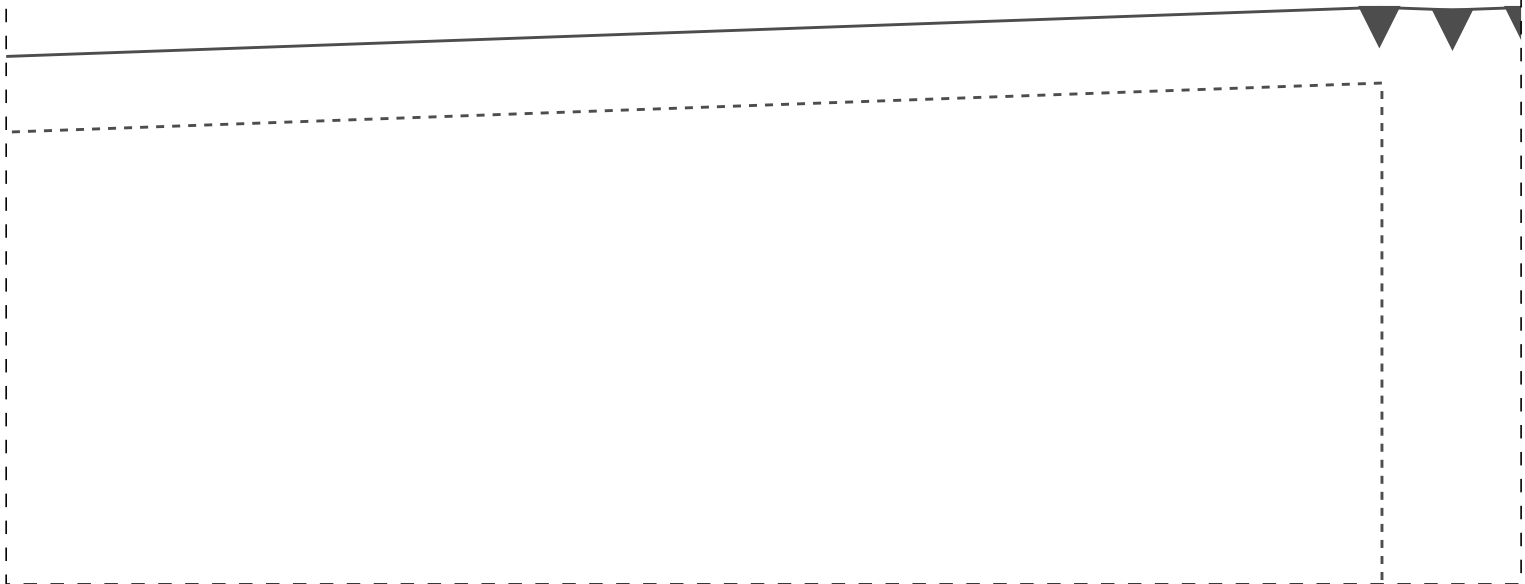

IDDS04





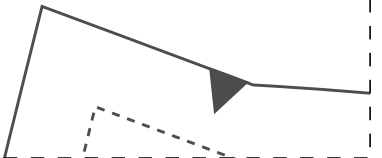
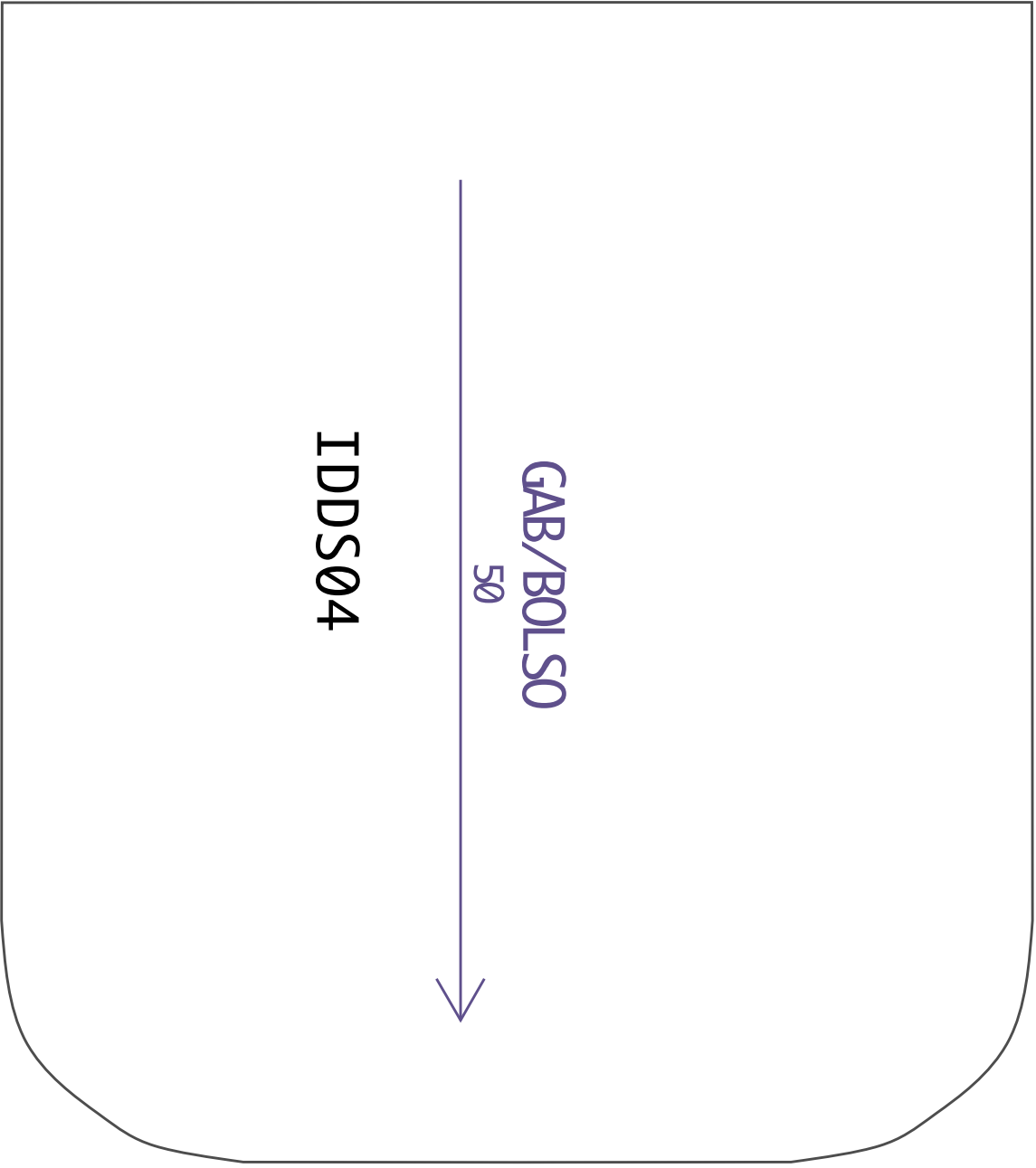

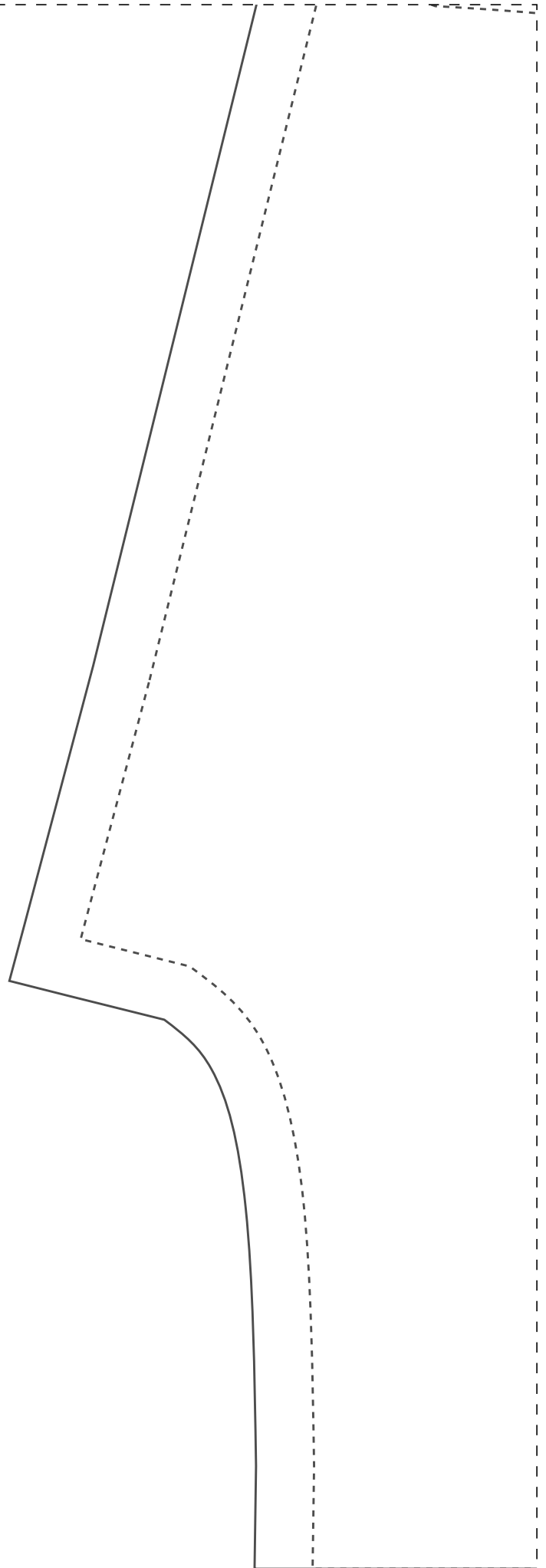

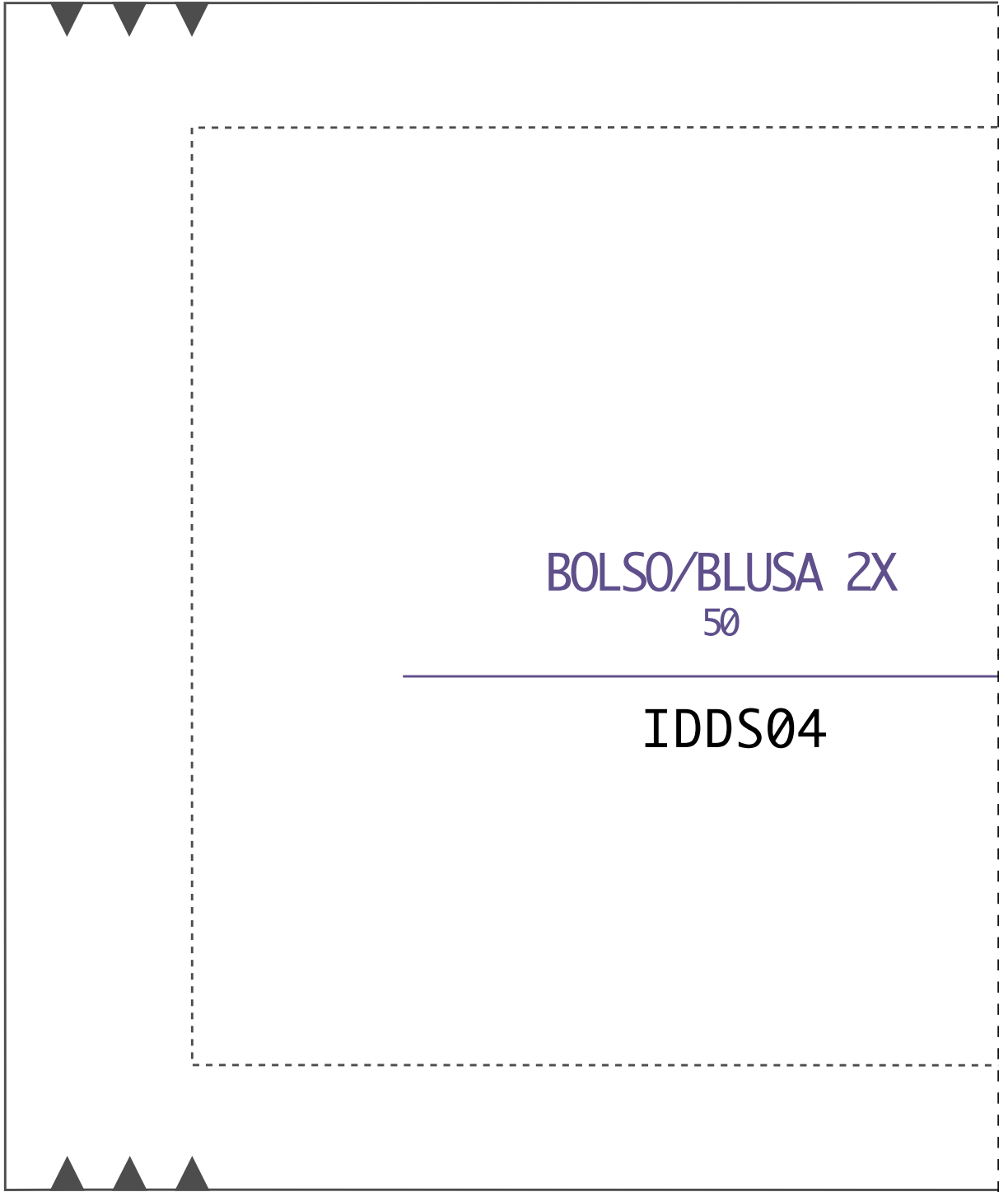

BOLSO/BLUSA 2X  
50

---

IDDS04

---

1-7

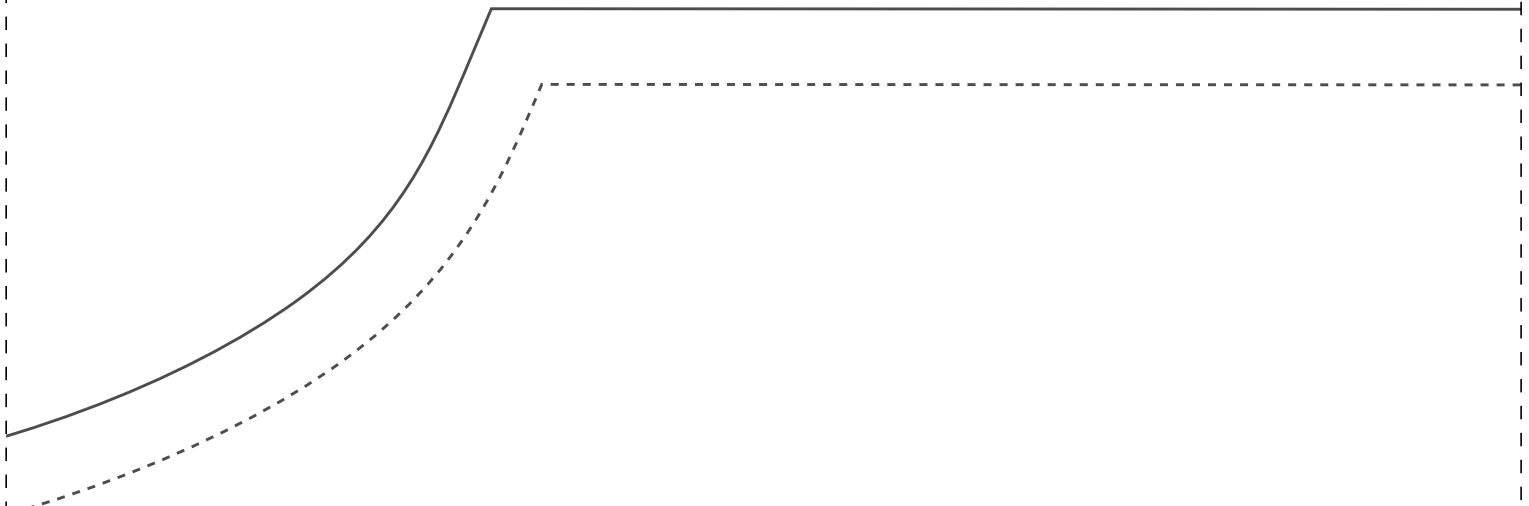
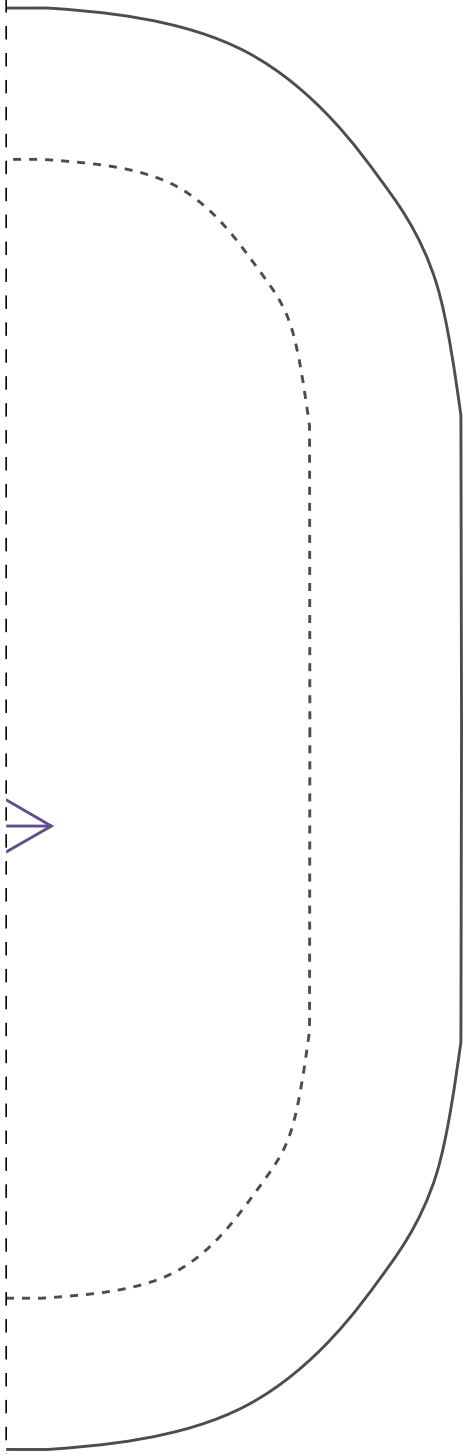

COSTAS 1X  
50

DOBRA

Teste de impressão: ao imprimir seu molde, meça o quadrado que deverá ter a mesma medida informada (4cm), assim você se certificará que ele foi impresso no tamanho correto.

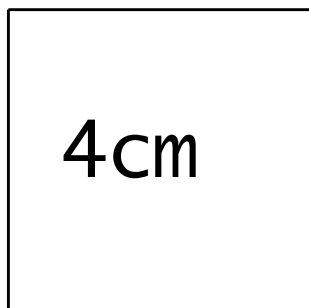

IDDS04





DOBRA

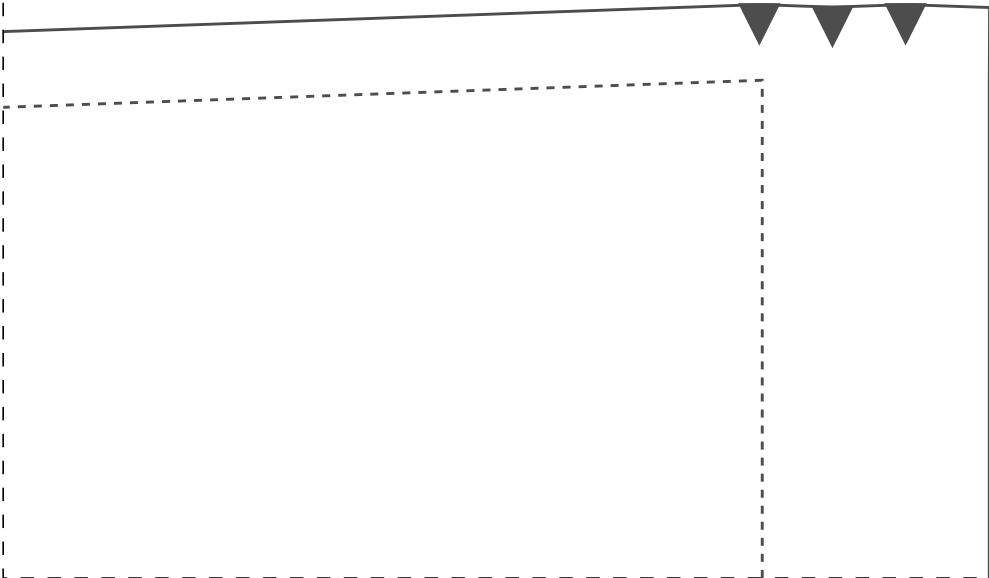
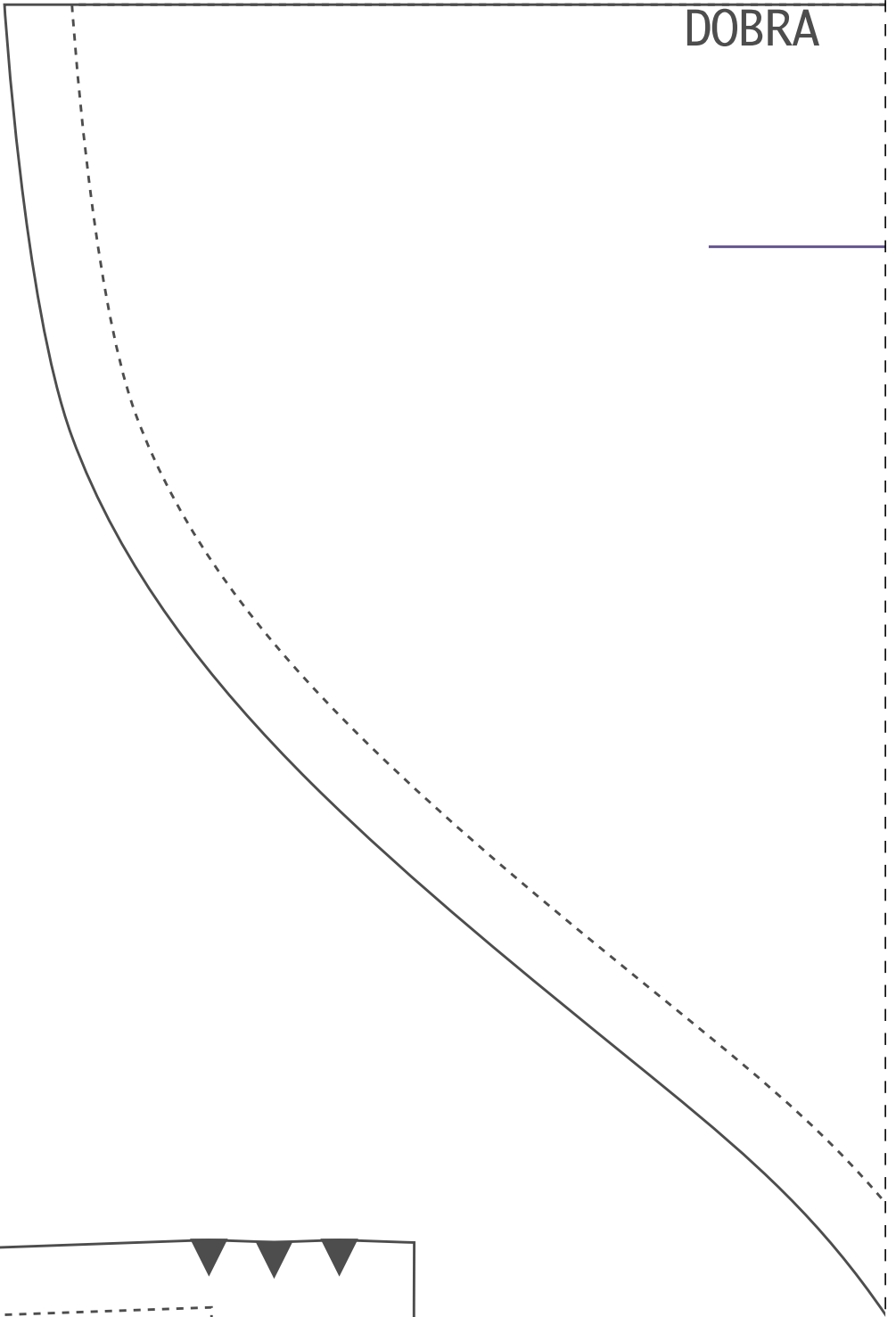



1-10



MANGA 2X  
50

IDDS04



2-10

