

2-1

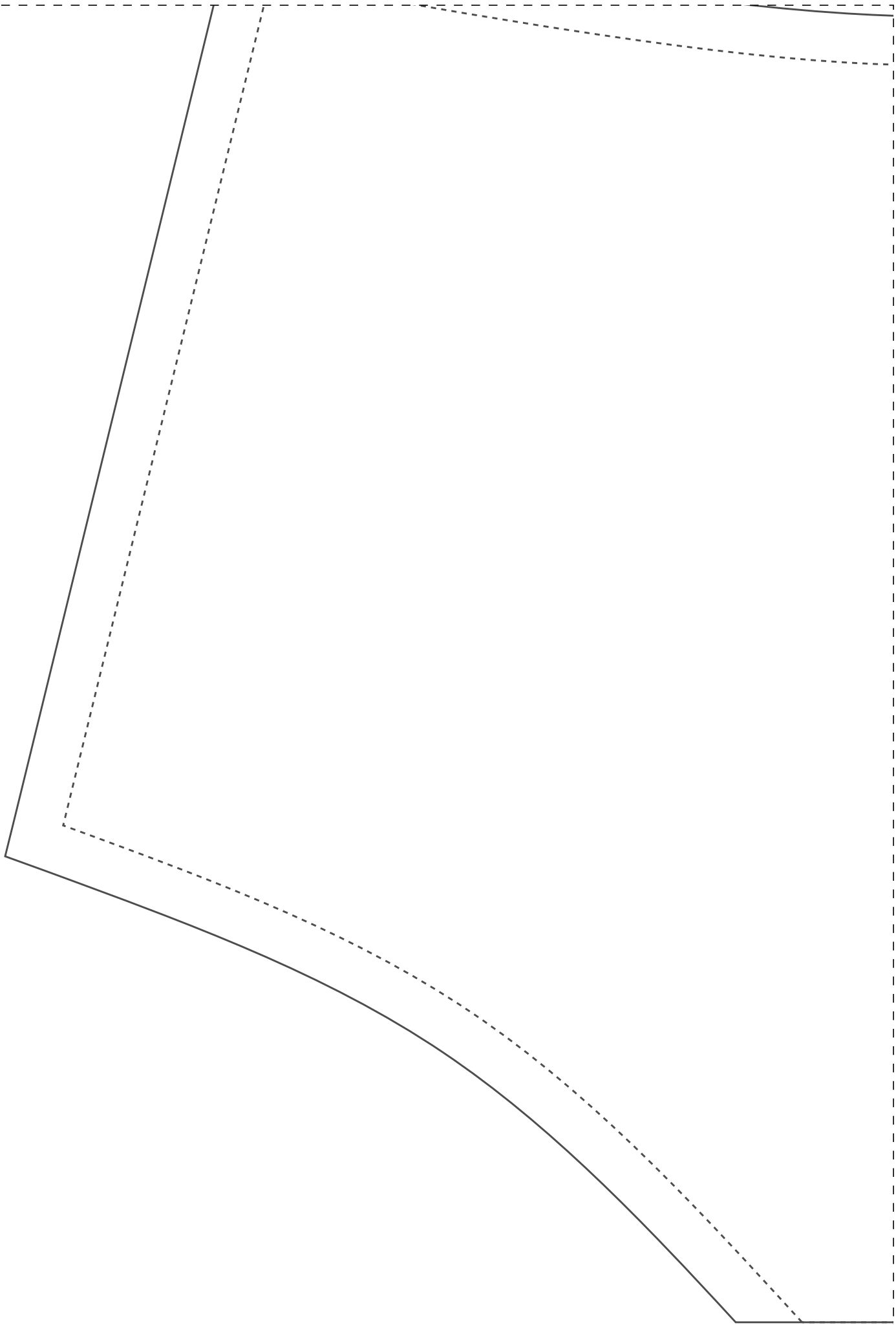

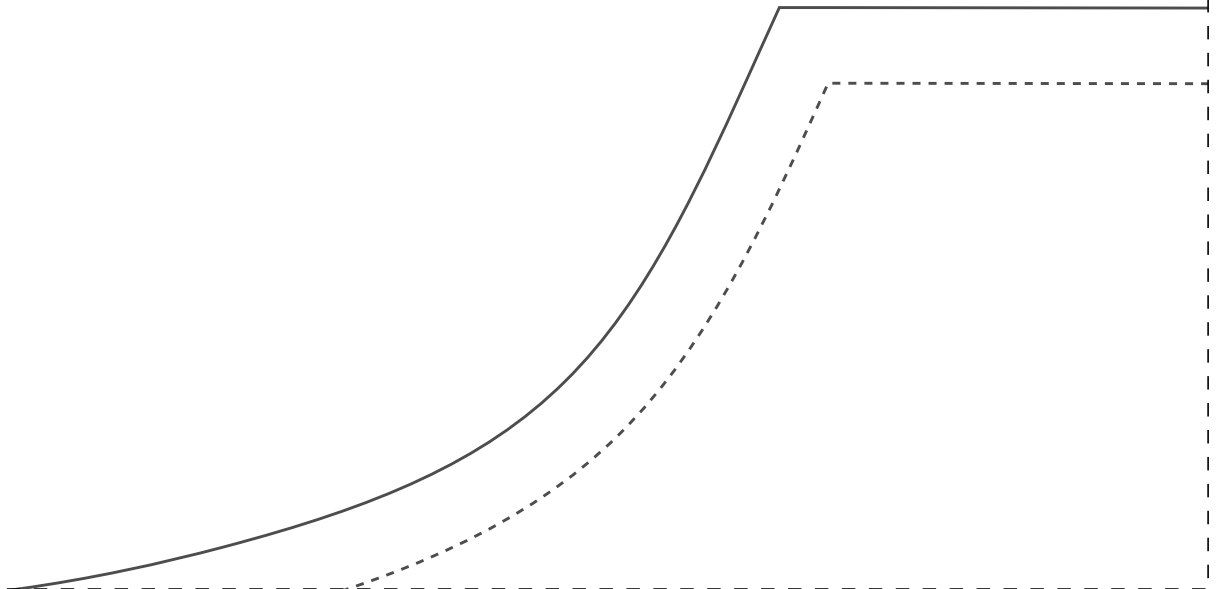
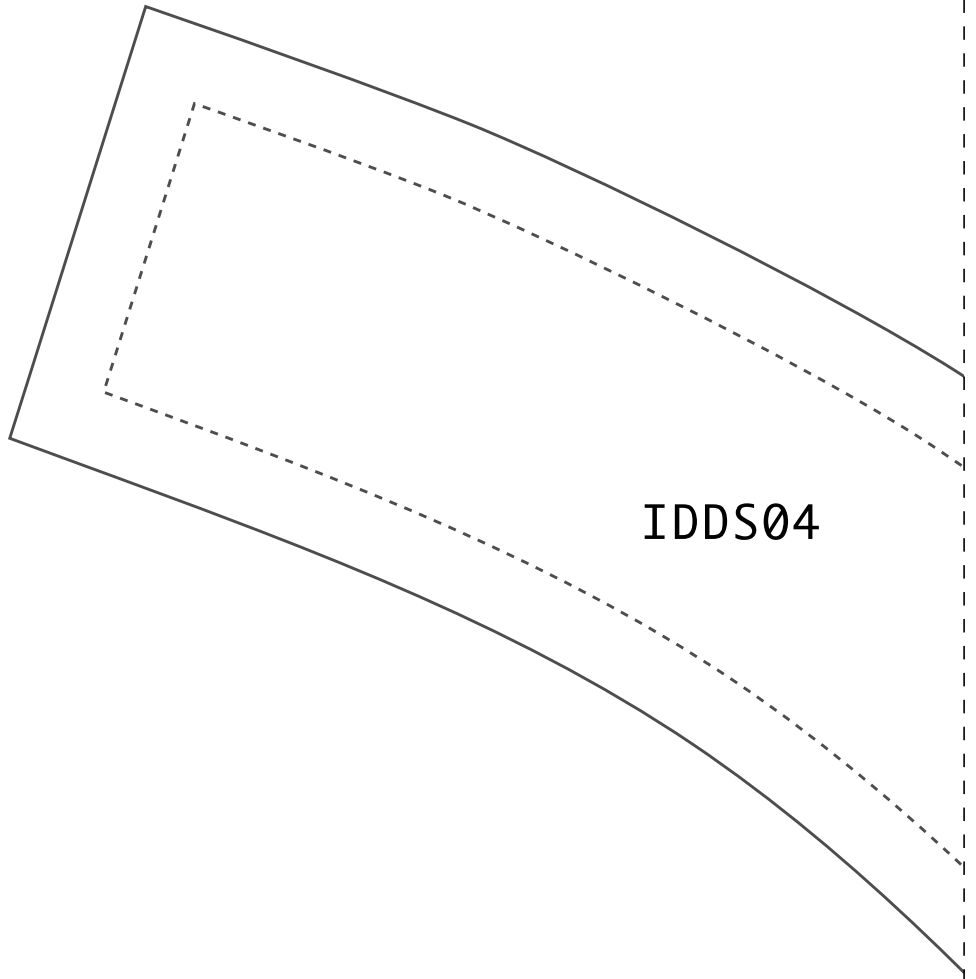

Instituto Diana Demarchi
Curso de Uniformes da Saúde
Blusa Pijama Cirúrgico
Masculino

PROIBIDA REVENDA

1-3

REVEL
FRENTE
1X
52

DOBRA 

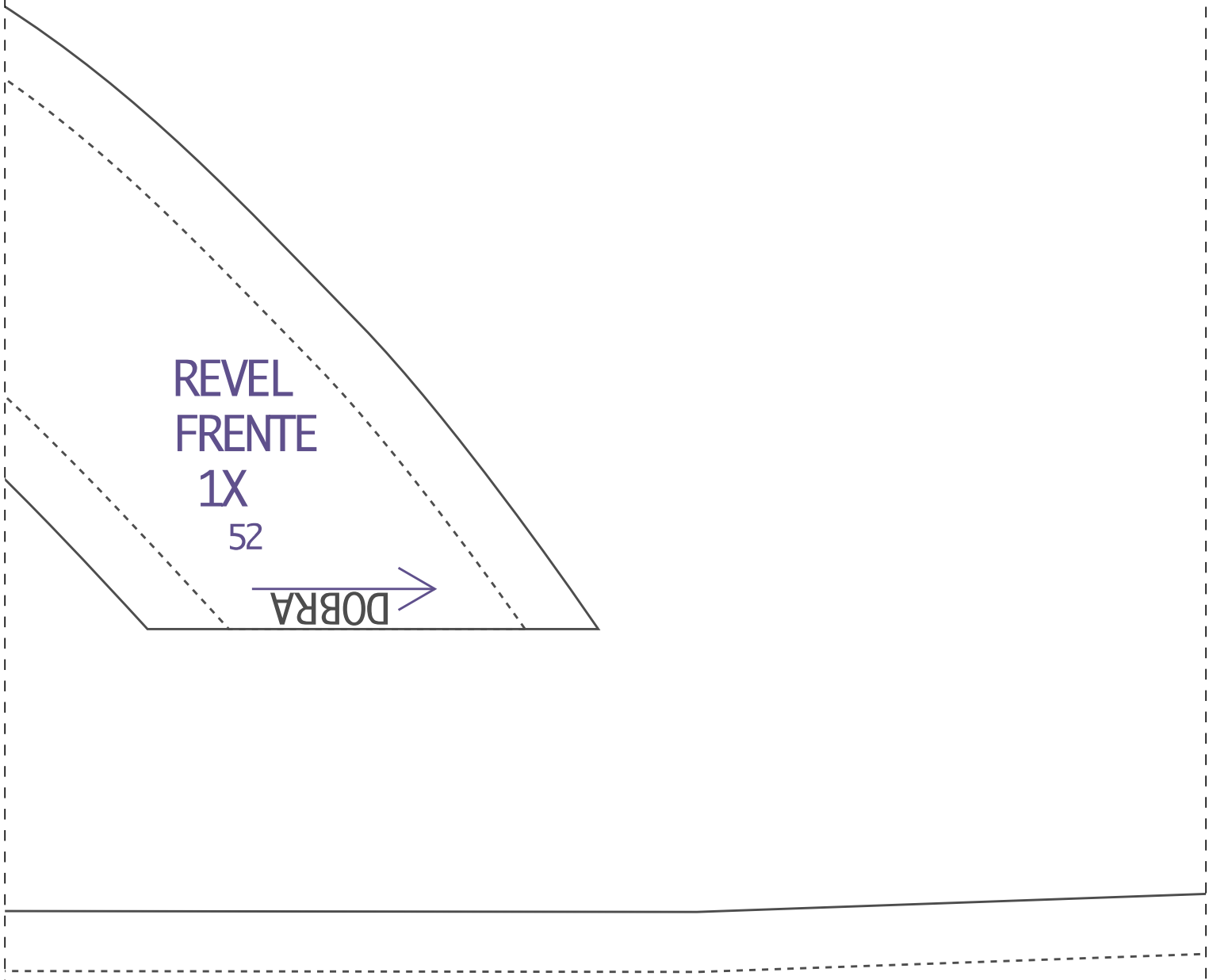

2-3

BOLSO

FRENTE 1X
52

DOBRA

1-4

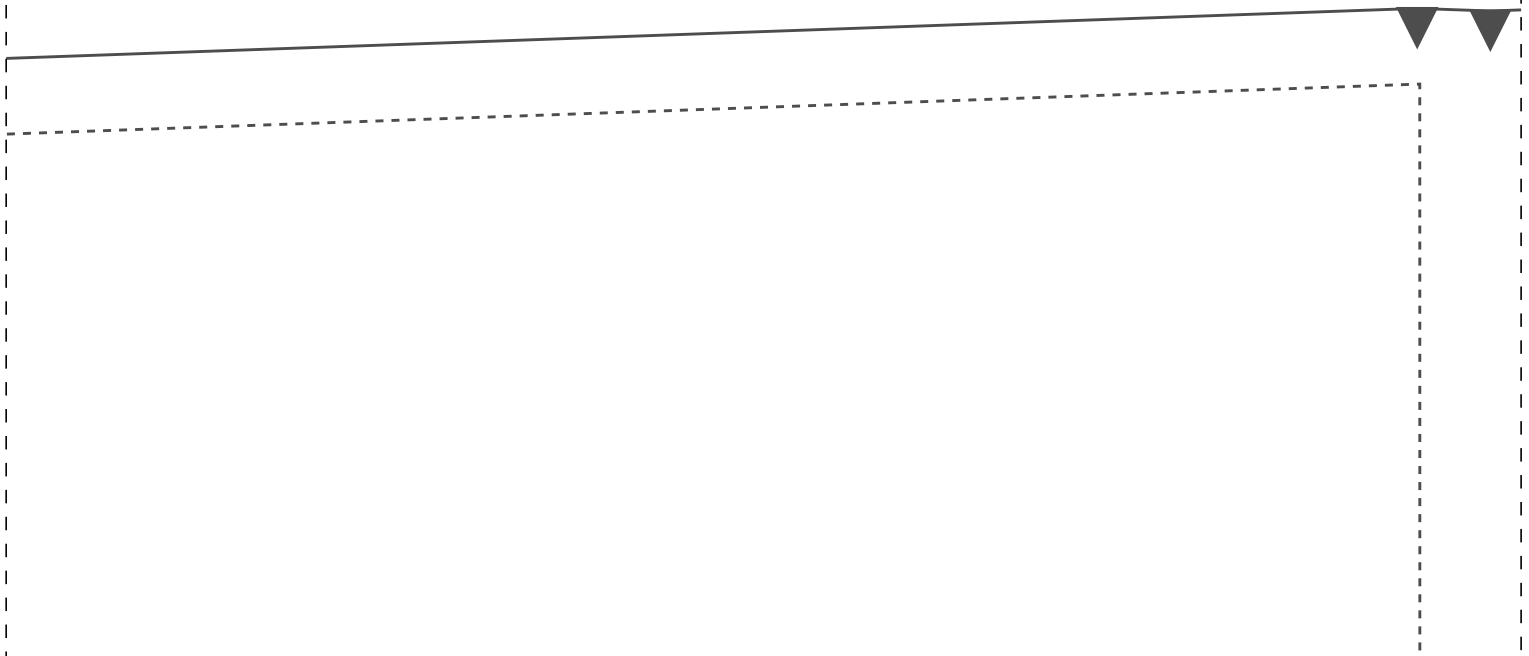

IDDS04



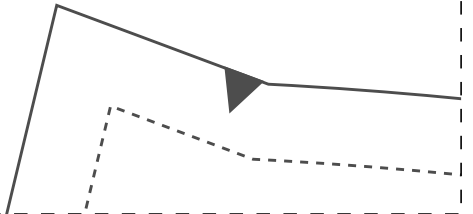
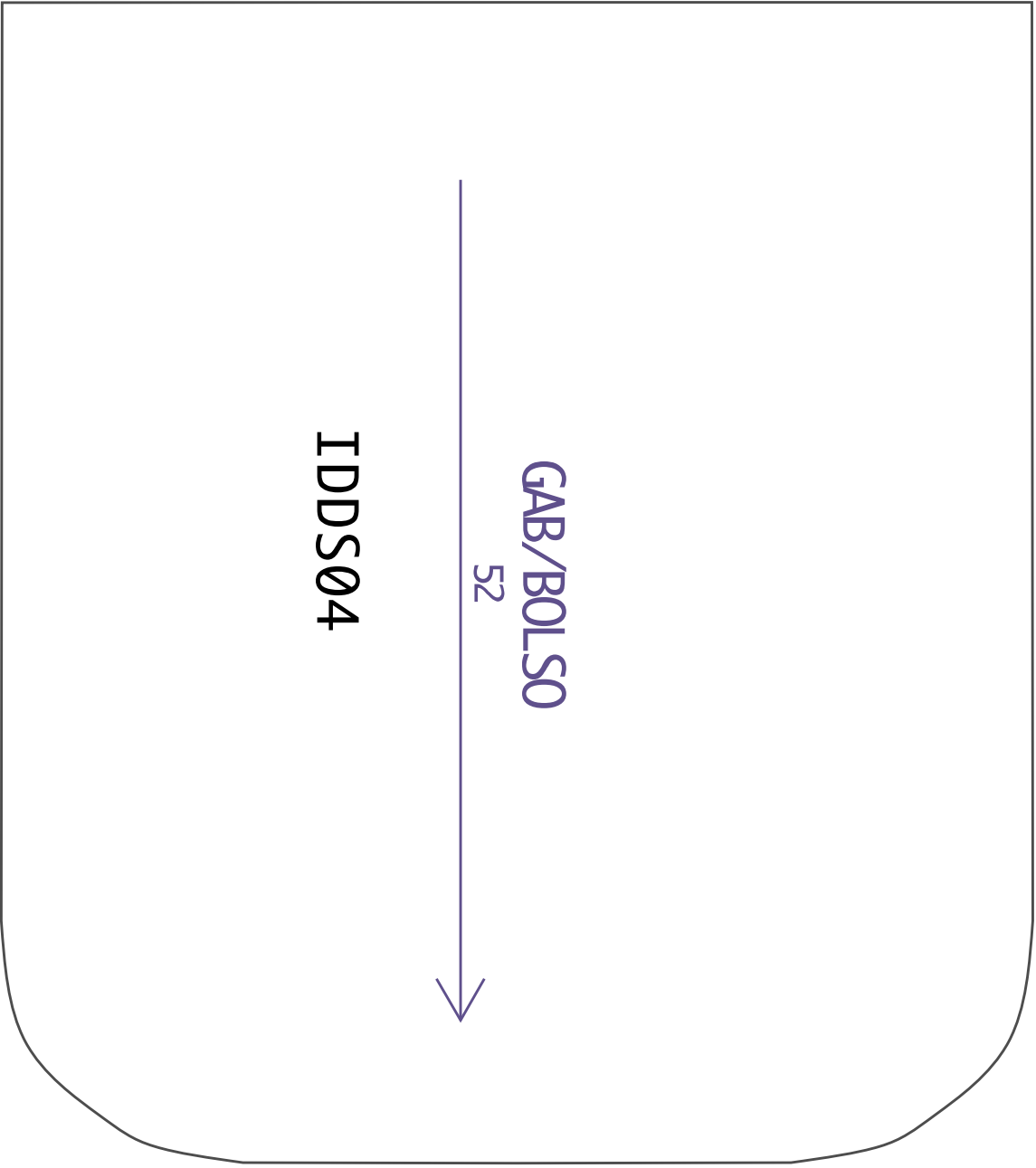

2-5

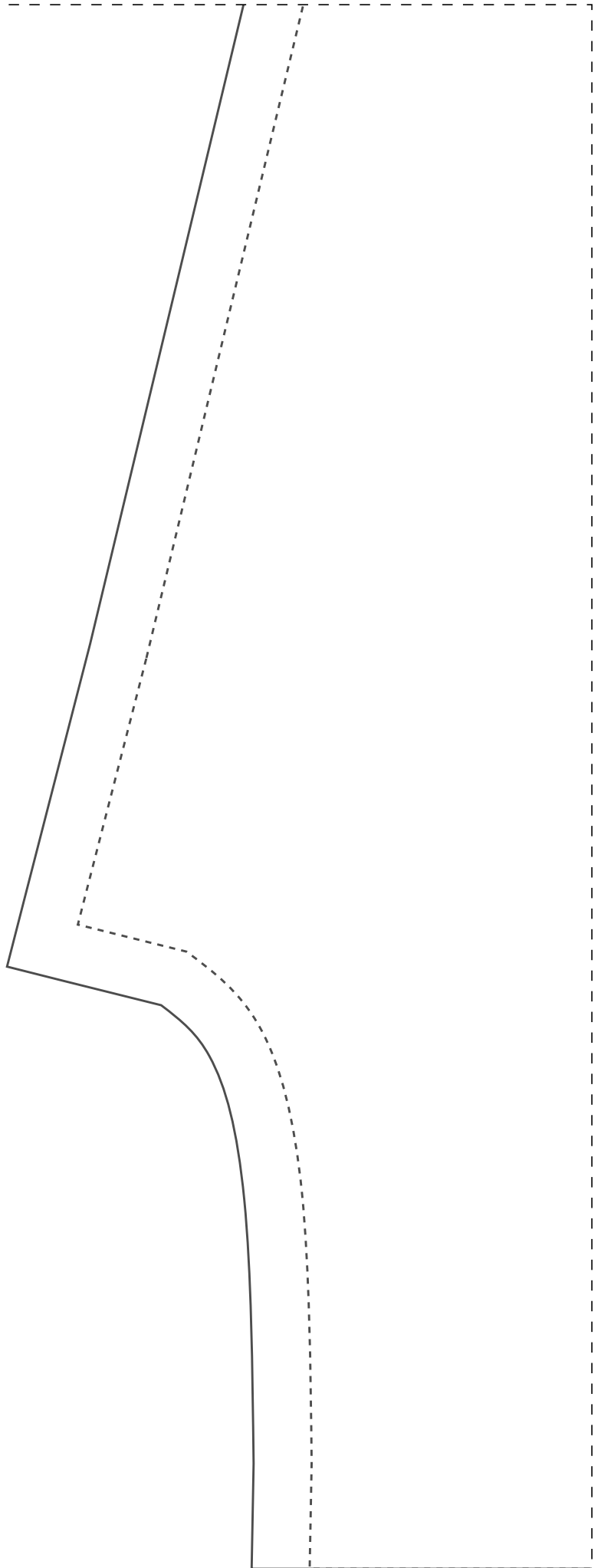

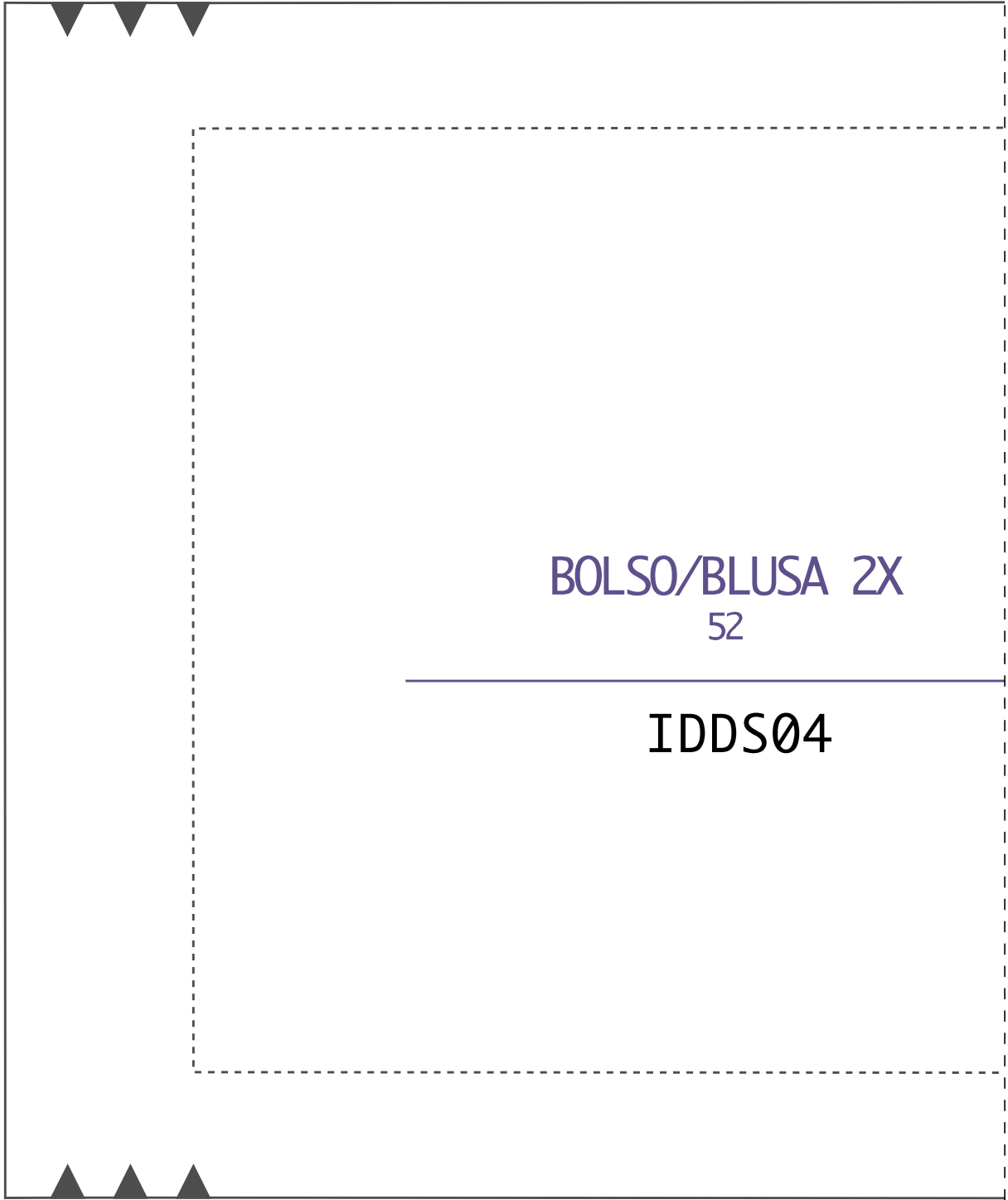

BOLSO/BLUSA 2X
52

IDDS04

1-7

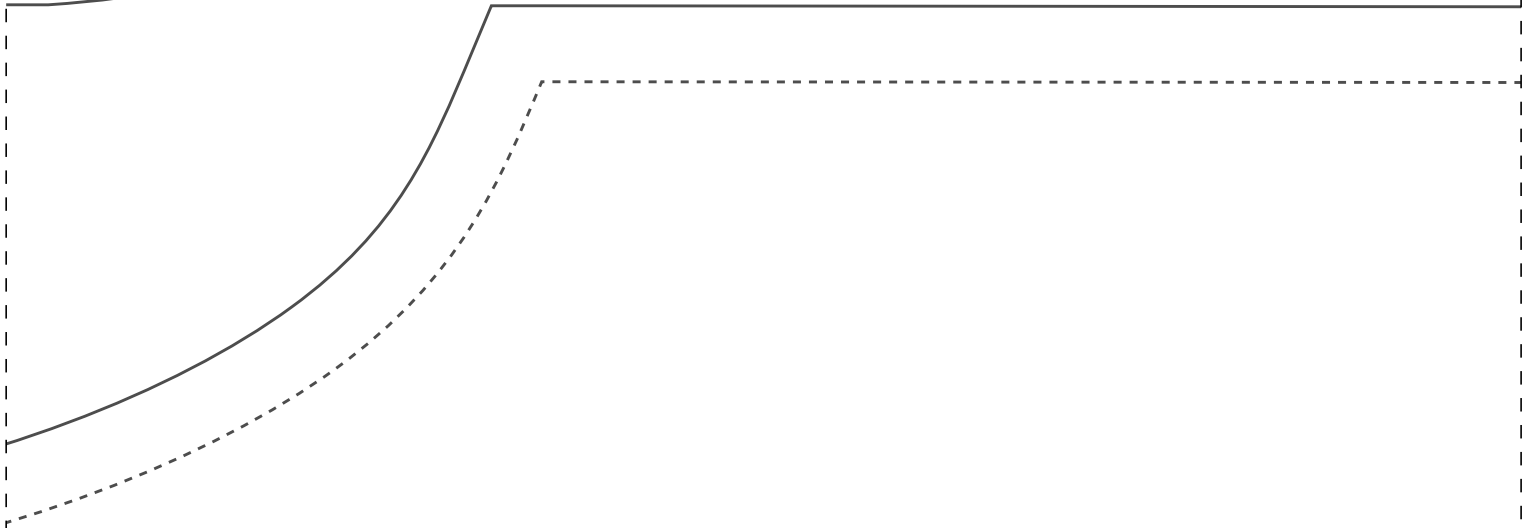
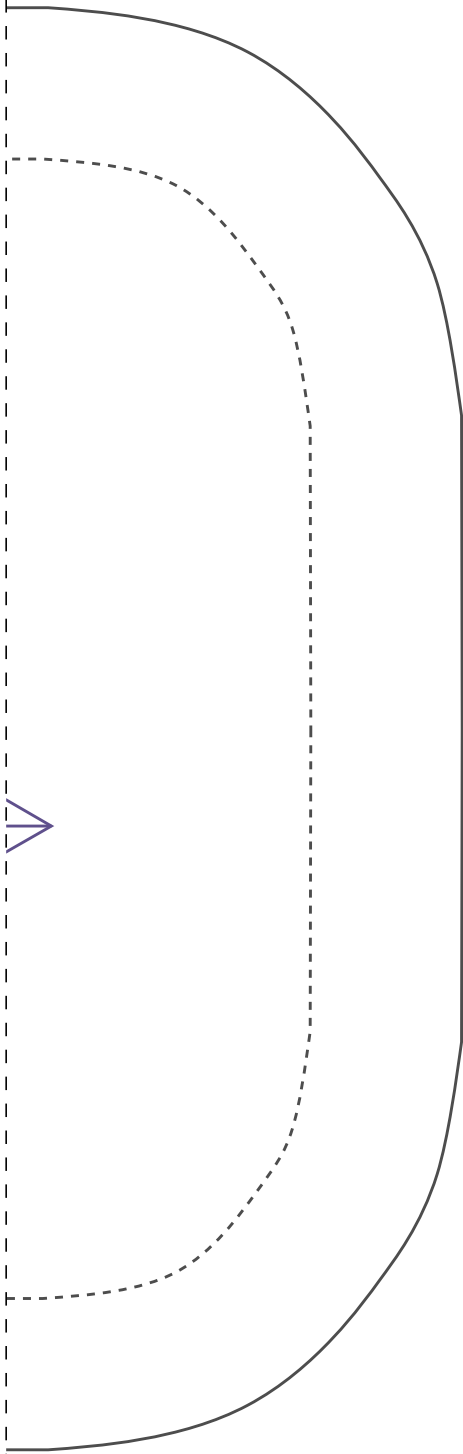

COSTAS 1X
52

DOBRA

Teste de impressão: ao imprimir seu molde, meça o quadrado que deverá ter a mesma medida informada (4cm), assim você se certificará que ele foi impresso no tamanho correto.

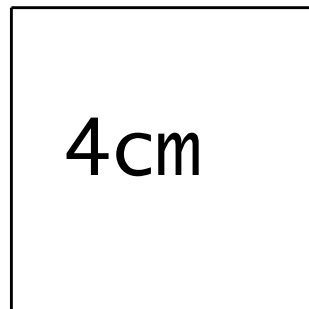

IDDS04



DOBRA

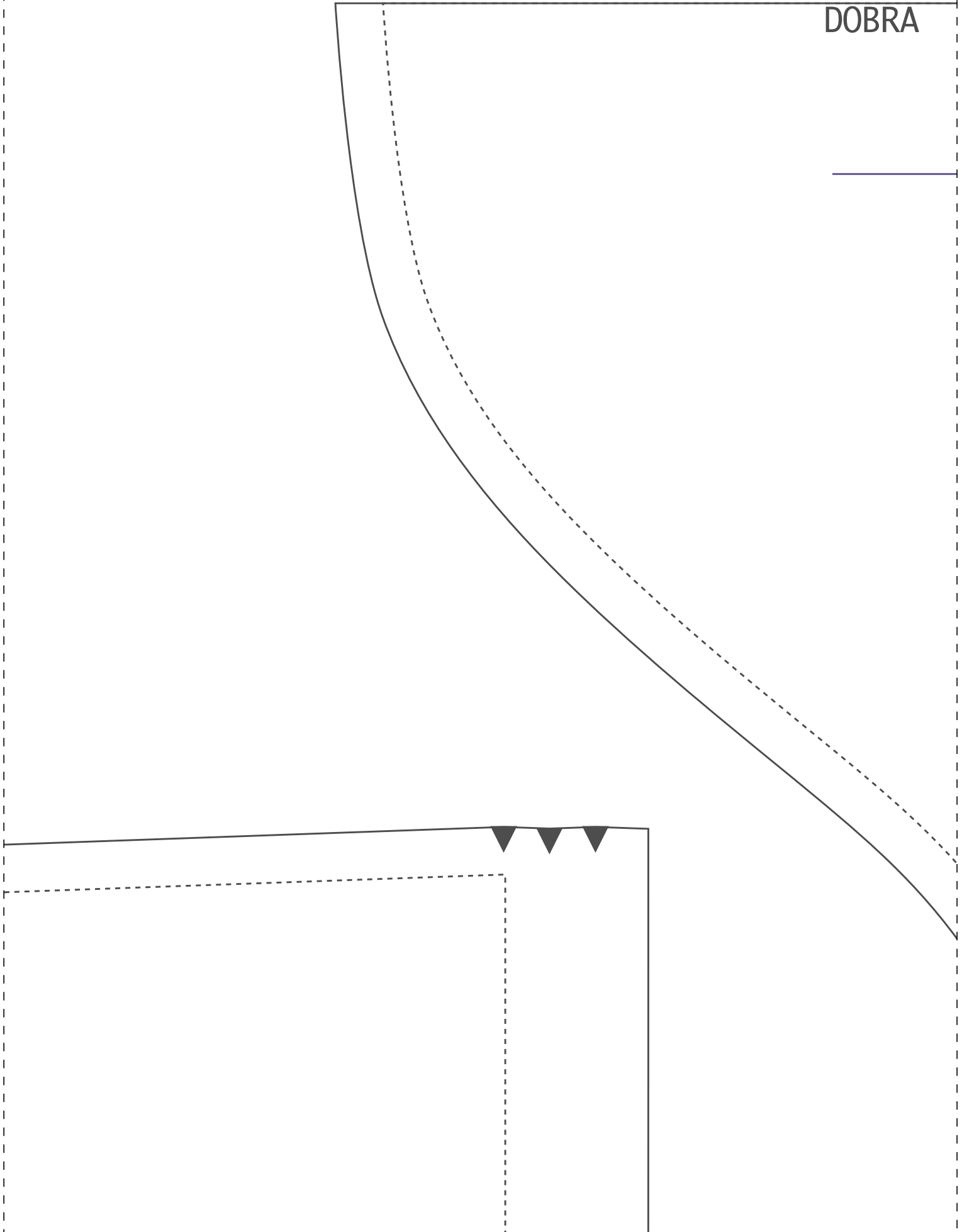



1-10



MANGA 2X
52

IDD SØ4

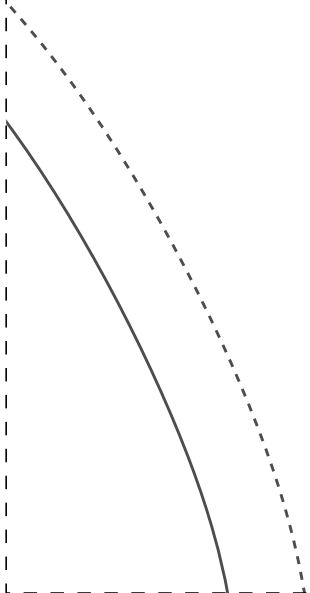

2-10

