

2-1

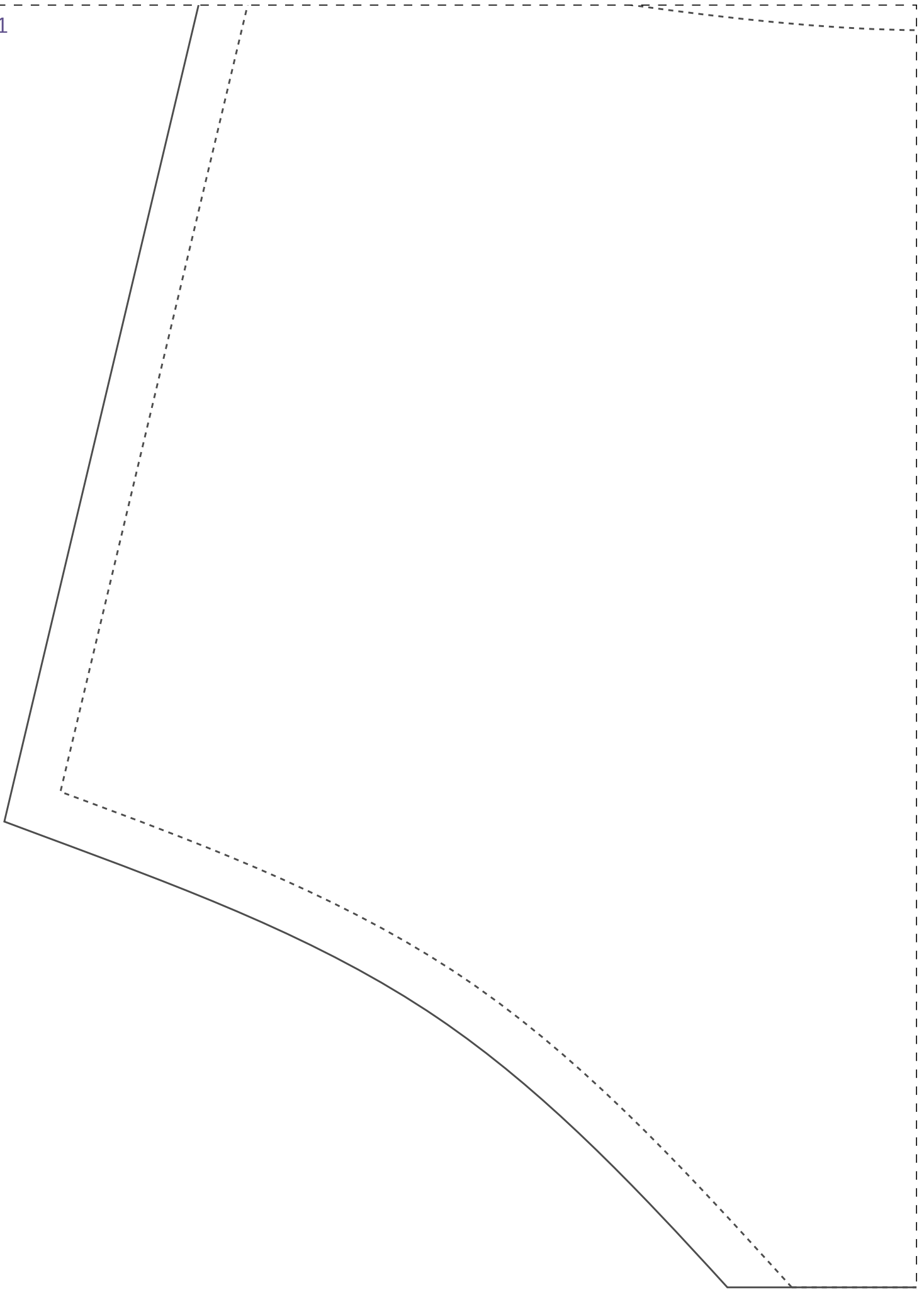

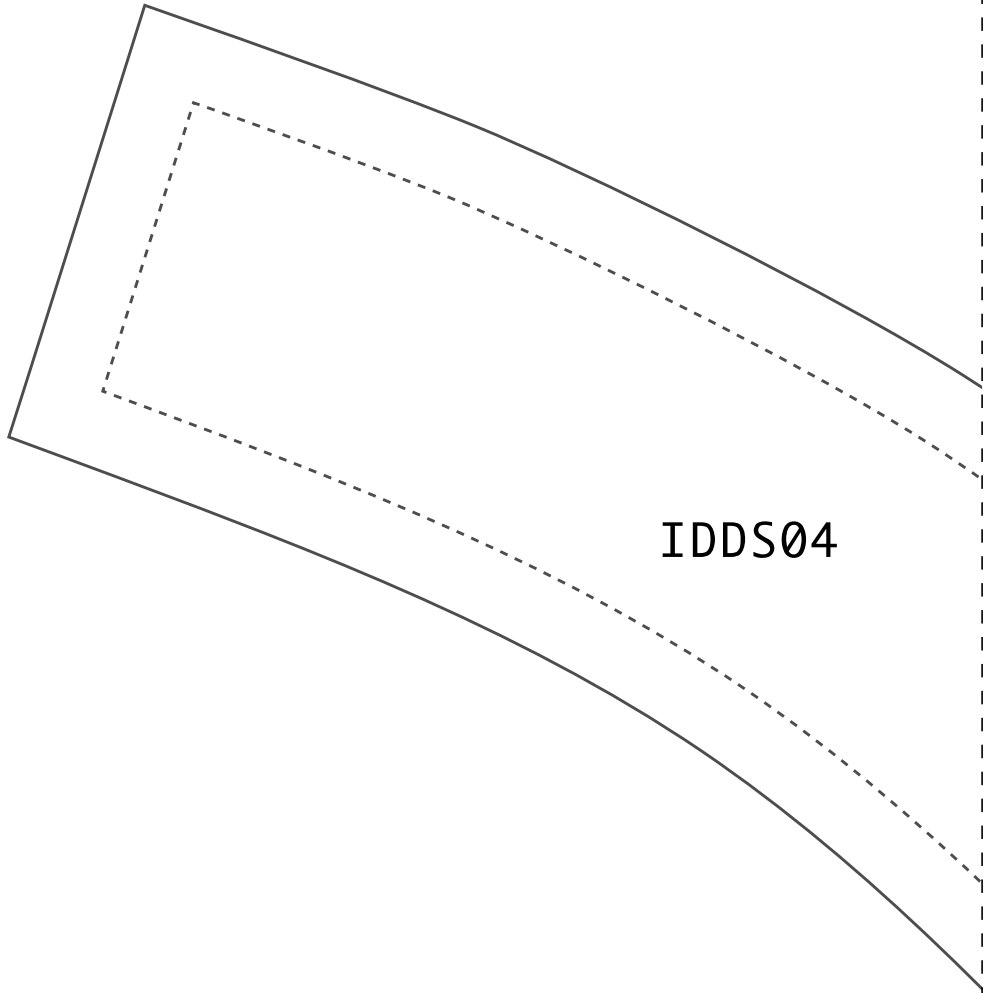

IDDS04

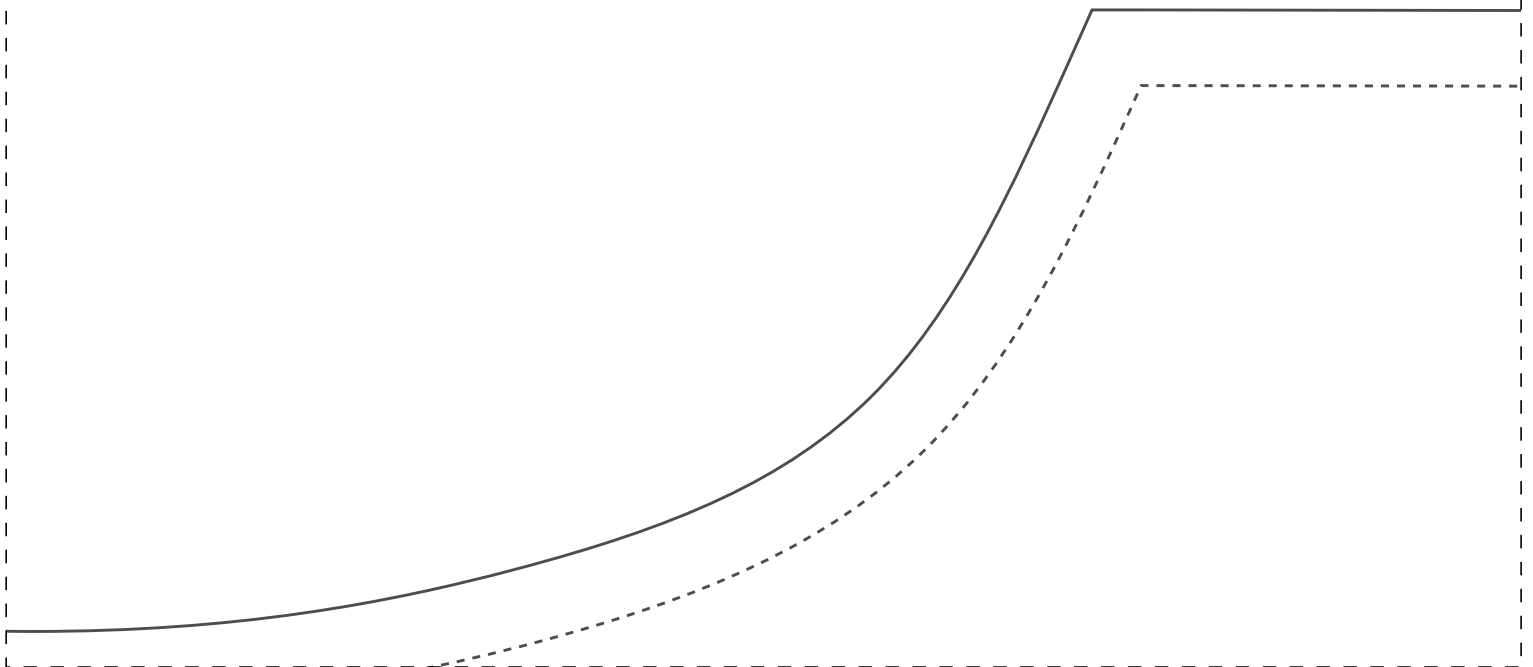

Instituto Diana Demarchi  
Curso de Uniformes da Saúde  
Blusa Pijama Cirúrgico  
Masculino

**PROIBIDA REVENDA**

---

---

1-3

REVEL  
FRENTE  
1X  
54

DOBRA 

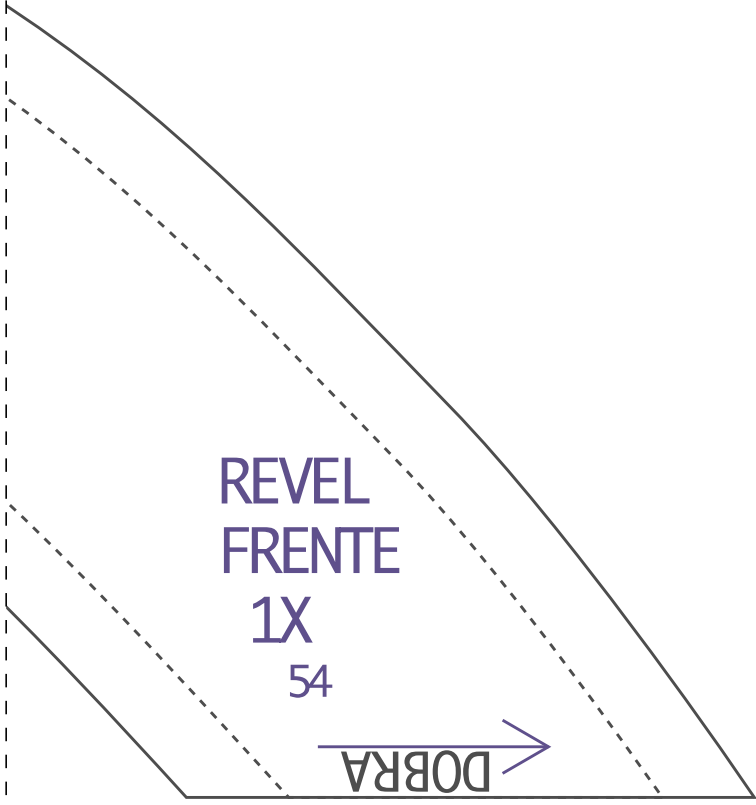

2-3

BOLSO

FRENTE 1X  
54

DOBRA



IDDS04





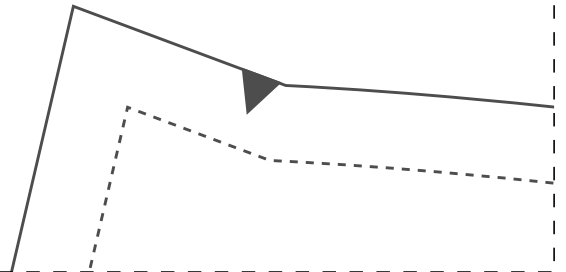
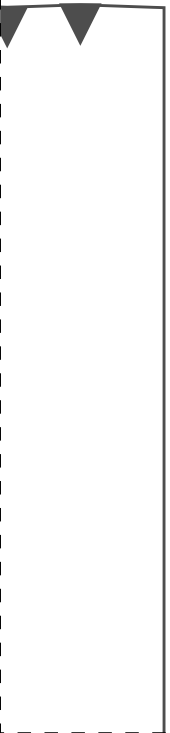
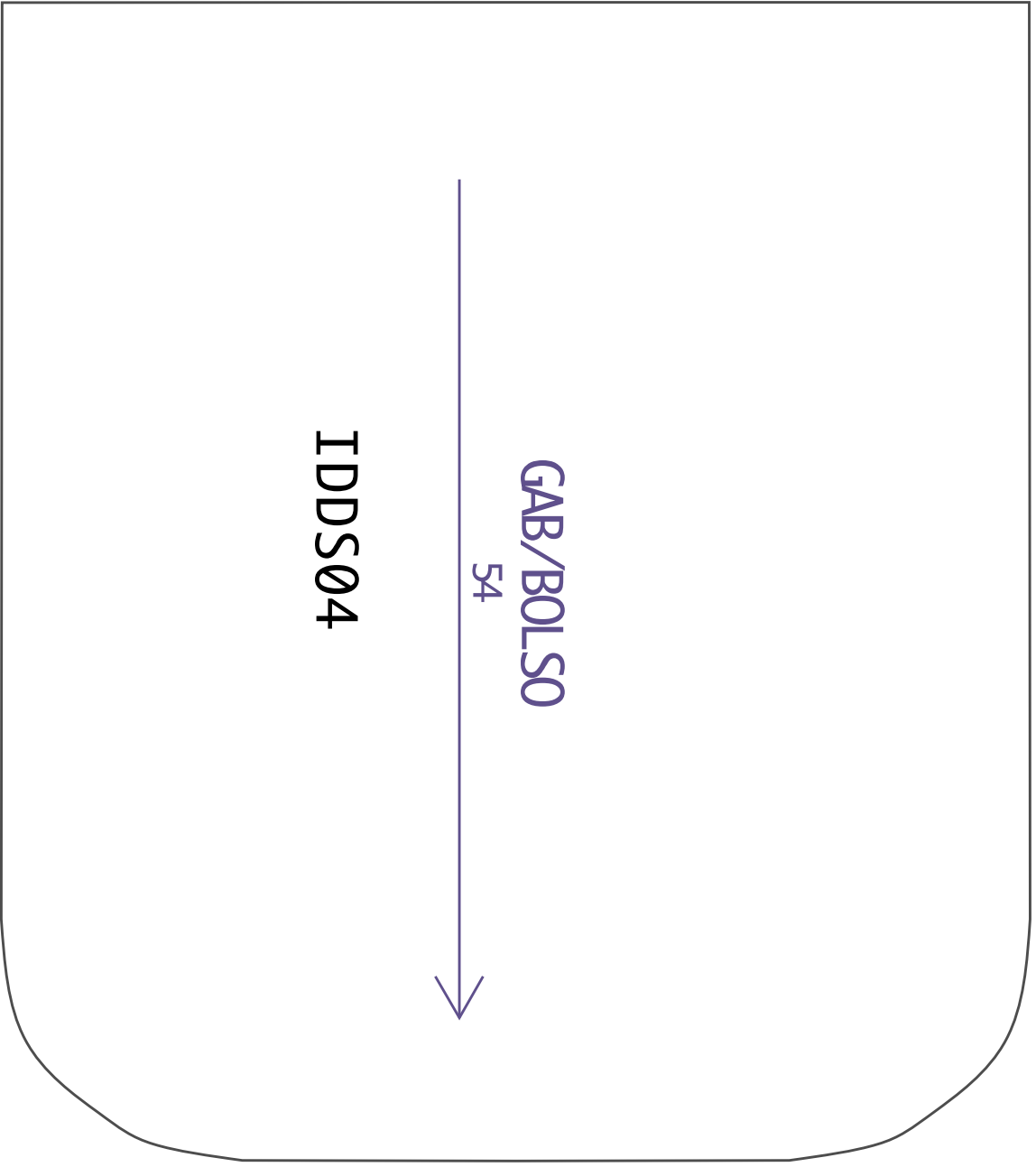

2-5

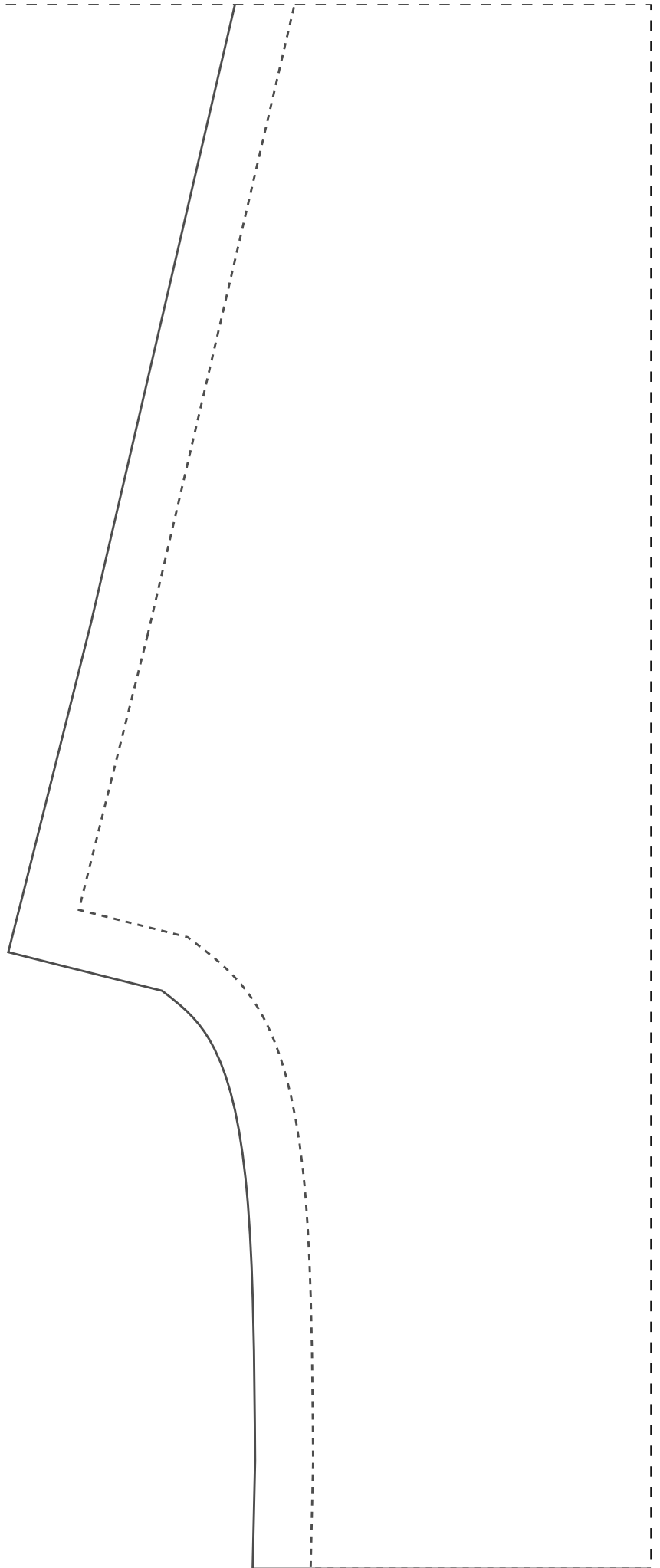

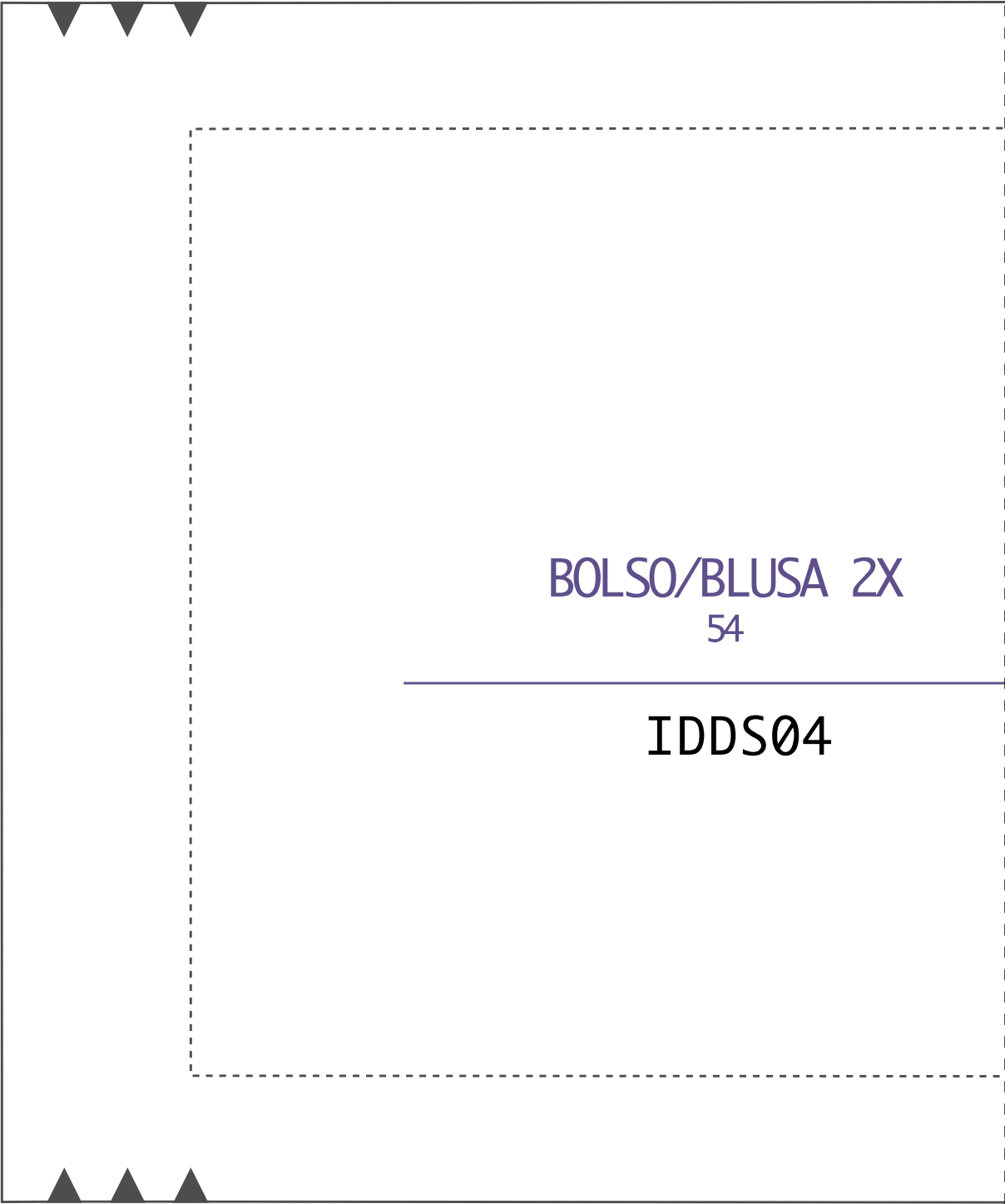

BOLSO/BLUSA 2X

54

---

IDDS04

---

---

1-7

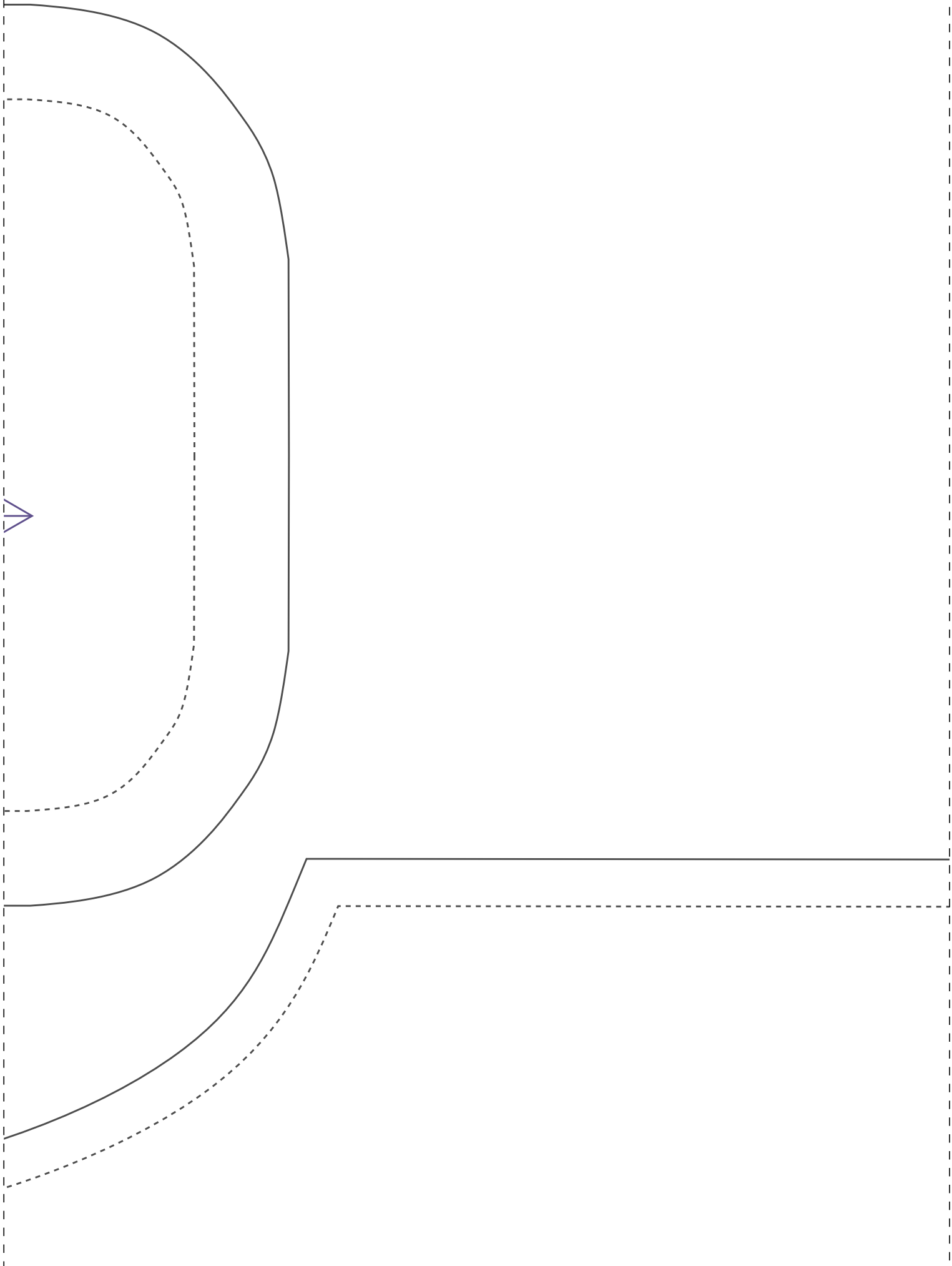

COSTAS 1X  
54

DOBRA

Teste de impressão: ao imprimir seu molde, meça o quadrado que deverá ter a mesma medida informada (4cm), assim você se certificará que ele foi impresso no tamanho correto.

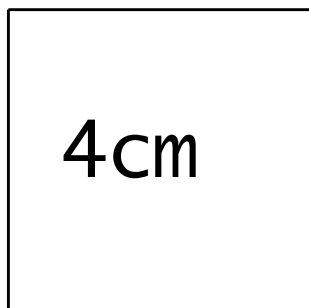

IDDS04





DOBRA

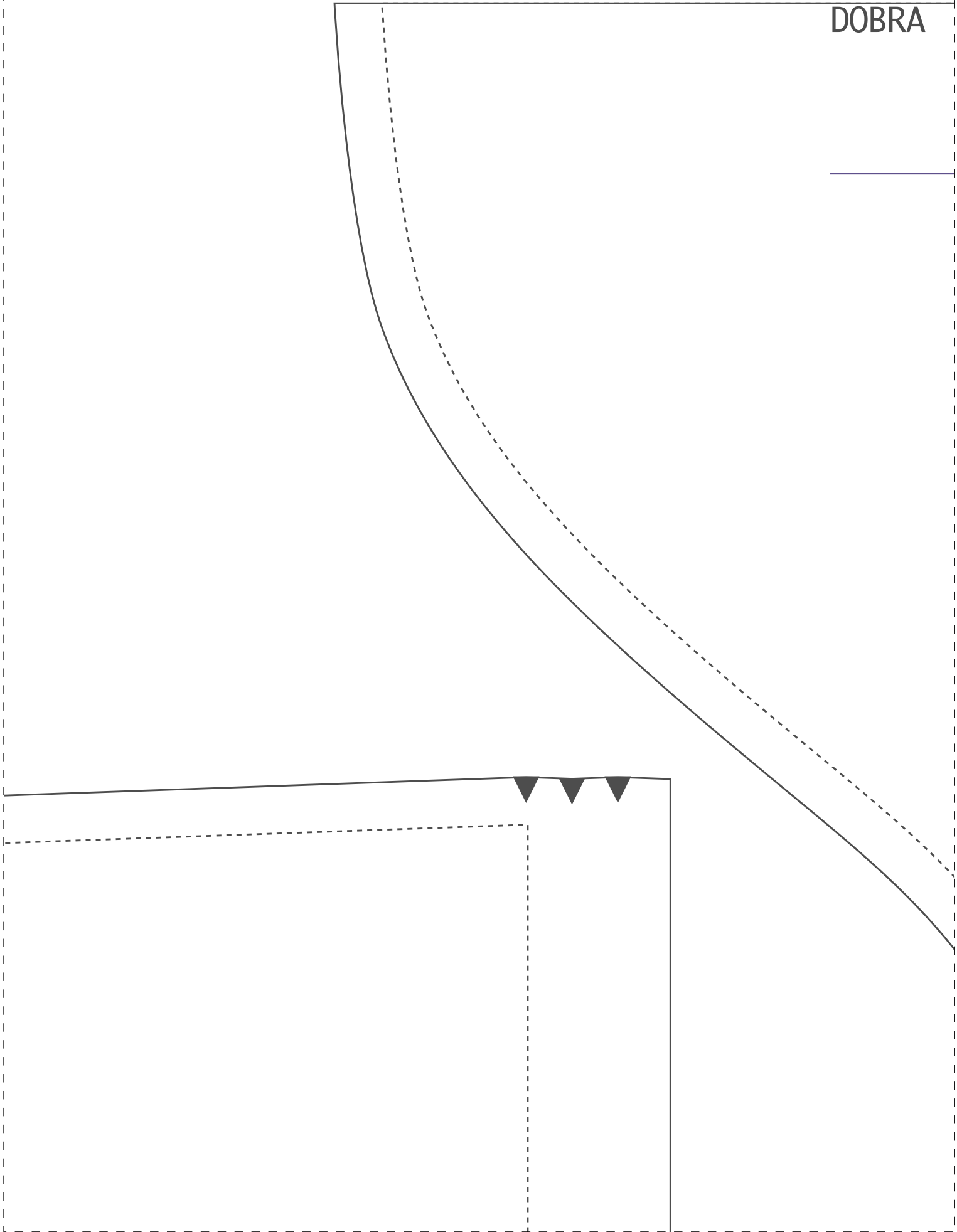



1-10

MANGA 2X  
54

IDDSØ4

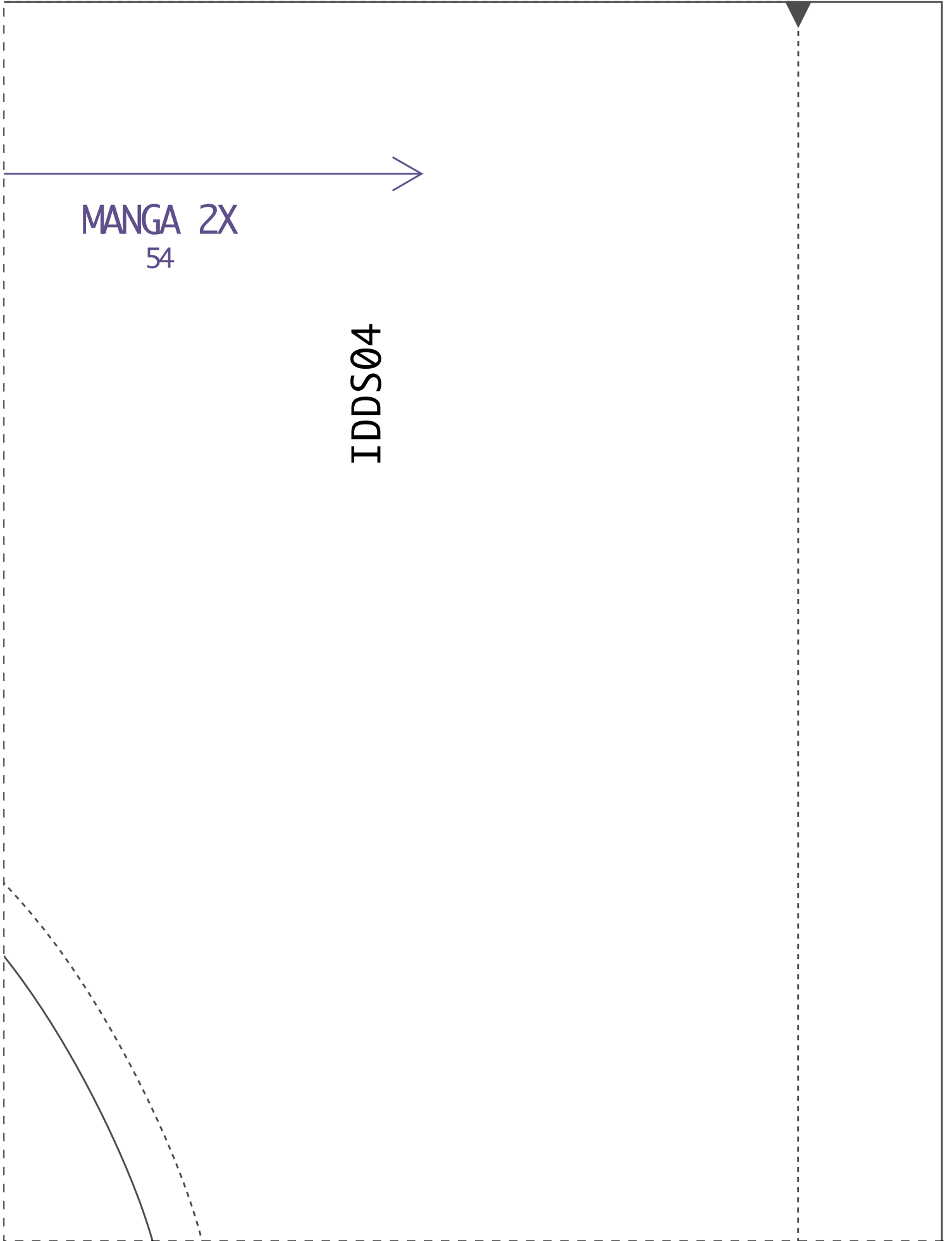

2-10

