

Teste de impressão: ao imprimir seu molde, meça o quadrado que deverá ter a mesma medida informada (4cm), assim você se certificará que ele foi impresso no tamanho correto.

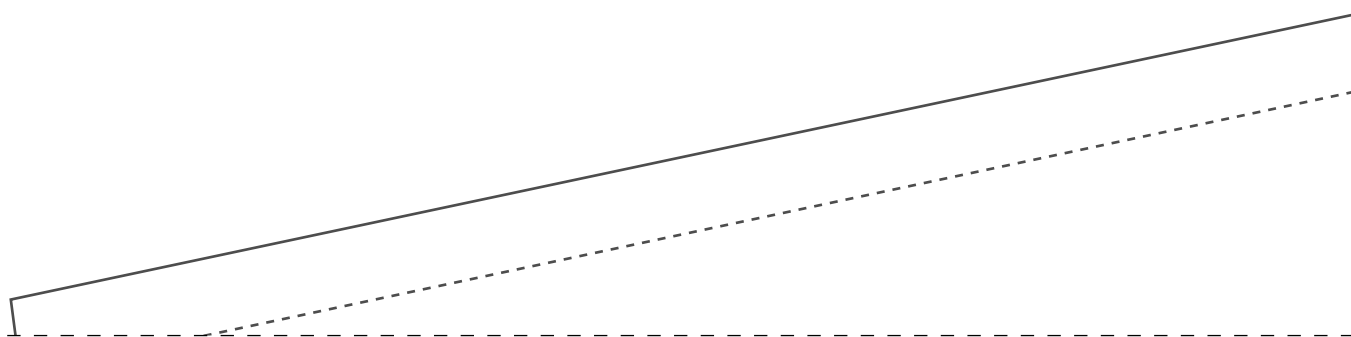
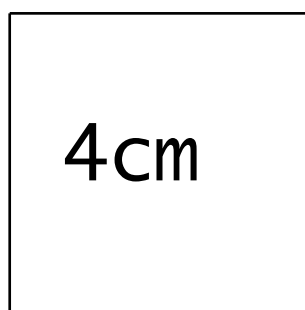

2-1

FICHA TÉCNICA

Tecido Plástico

-Crepe Flo

Gabardine,

-Cós com e

cortar elá

36: 72cm /

42: 78cm /

48: 84cm /

54: 90cm

-2,3m do 3

-2,5m do 4

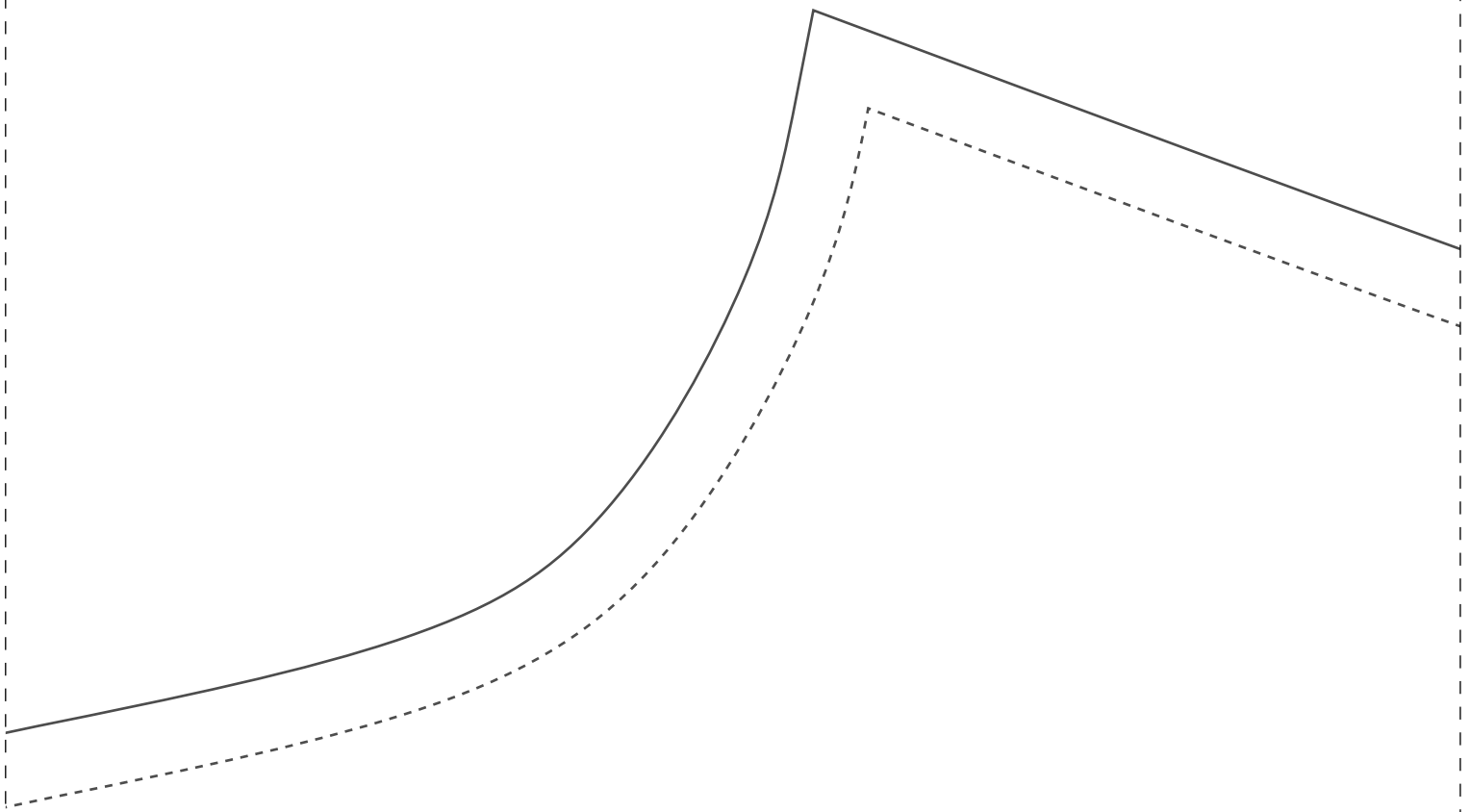

ICA:

no 1,4m larg

w, Oxfordine,

brim leve ou similares

lástico 4cm,

stico com:

38: 74cm / 40: 76cm

44: 80cm / 46: 82cm

50: 86cm / 52: 88cm

6 ao 44

6 ao 54

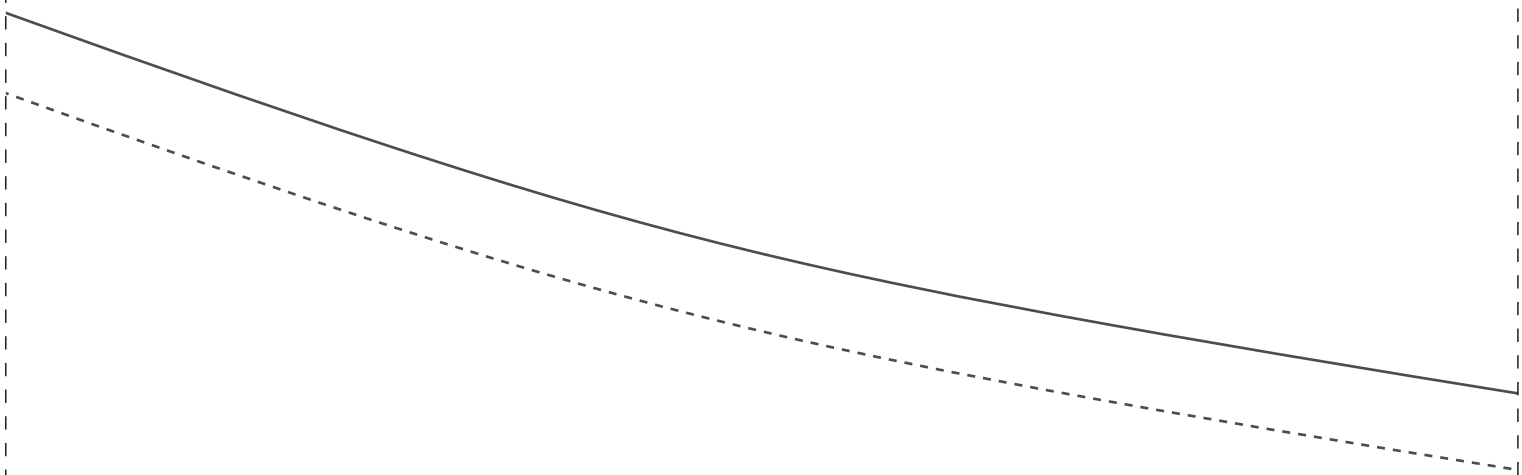

TRASEIRO 2X
38

IDDS05

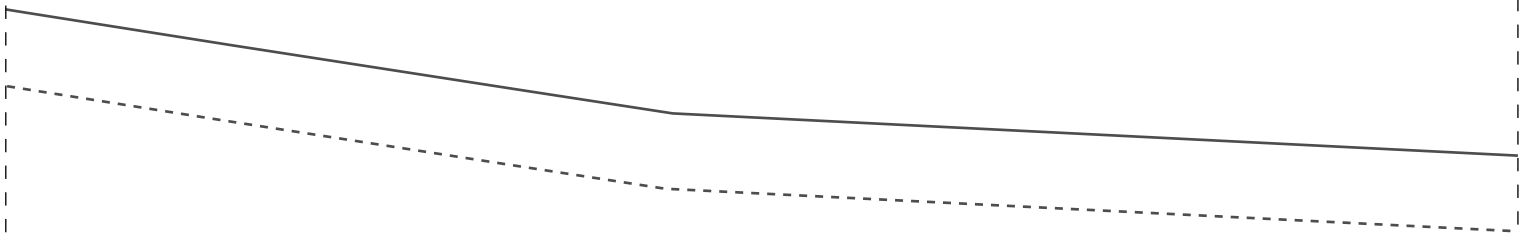
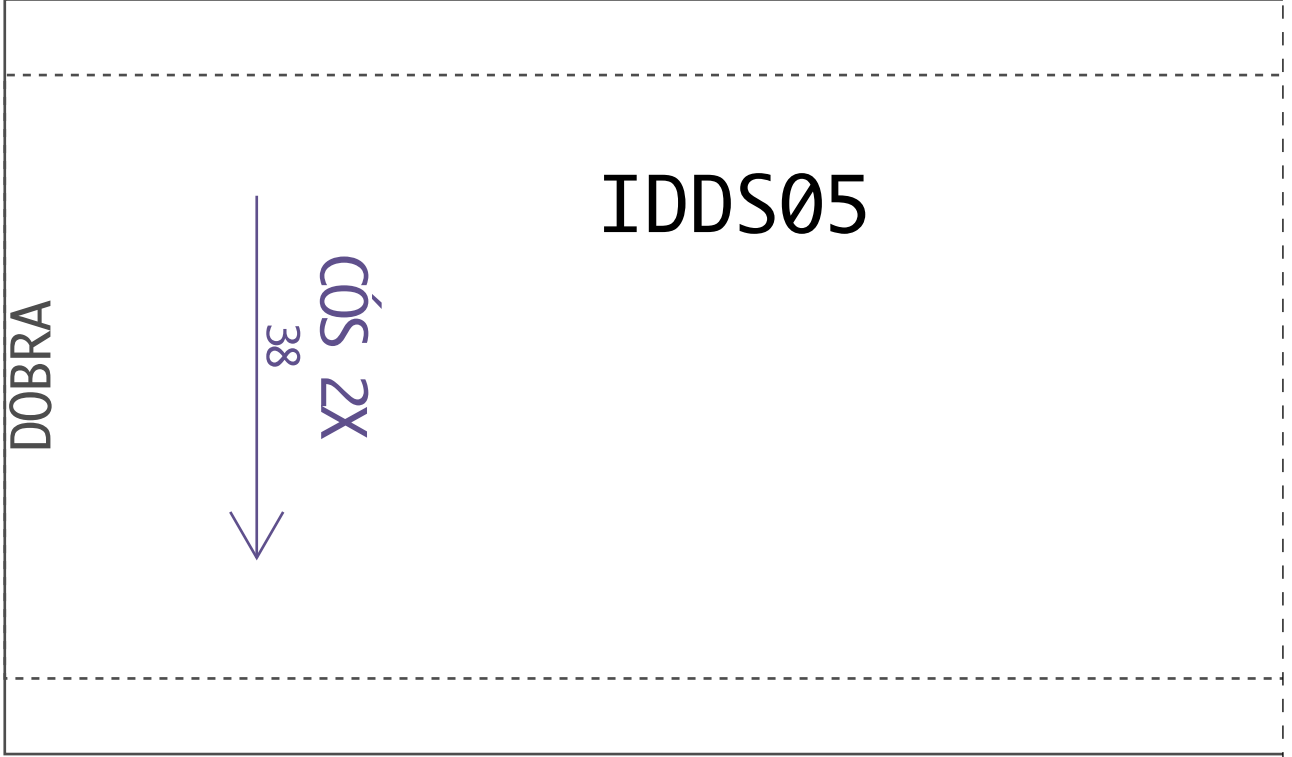

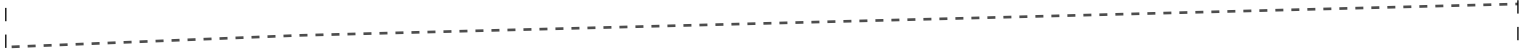

1-5

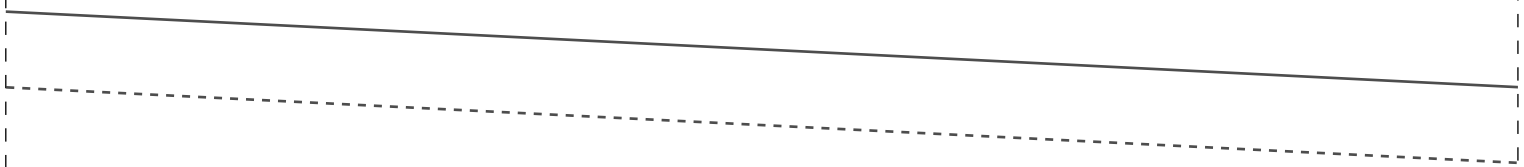
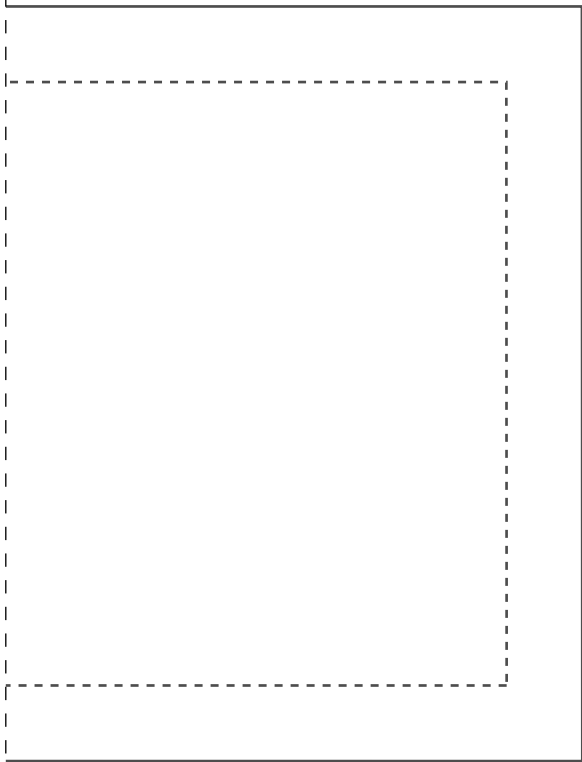

2-5



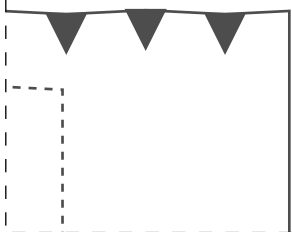

2-6

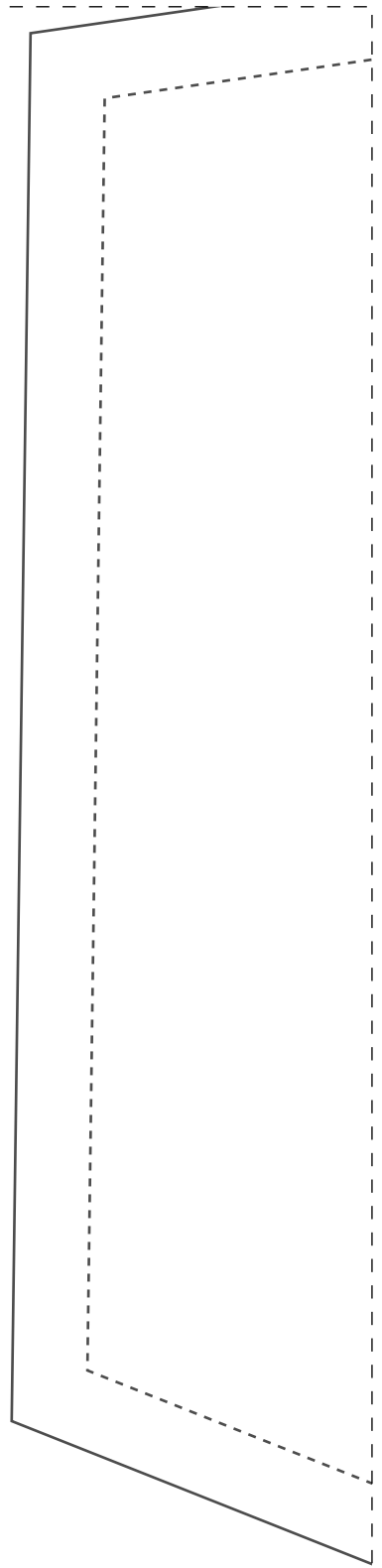
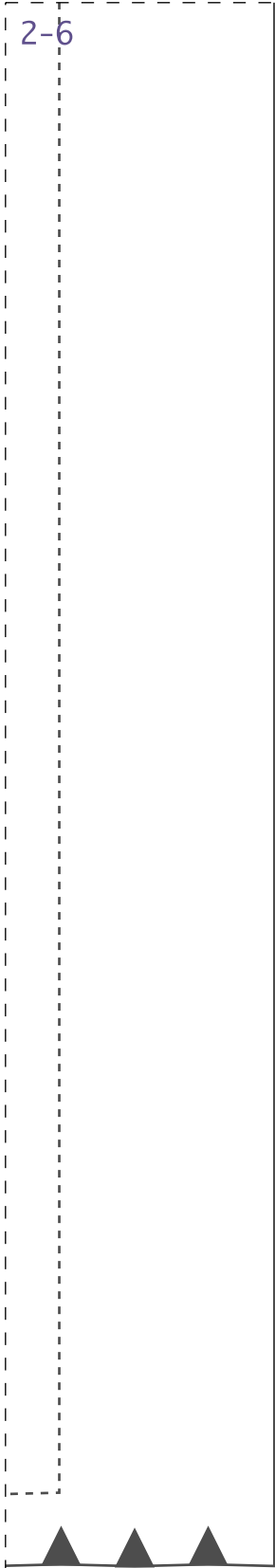

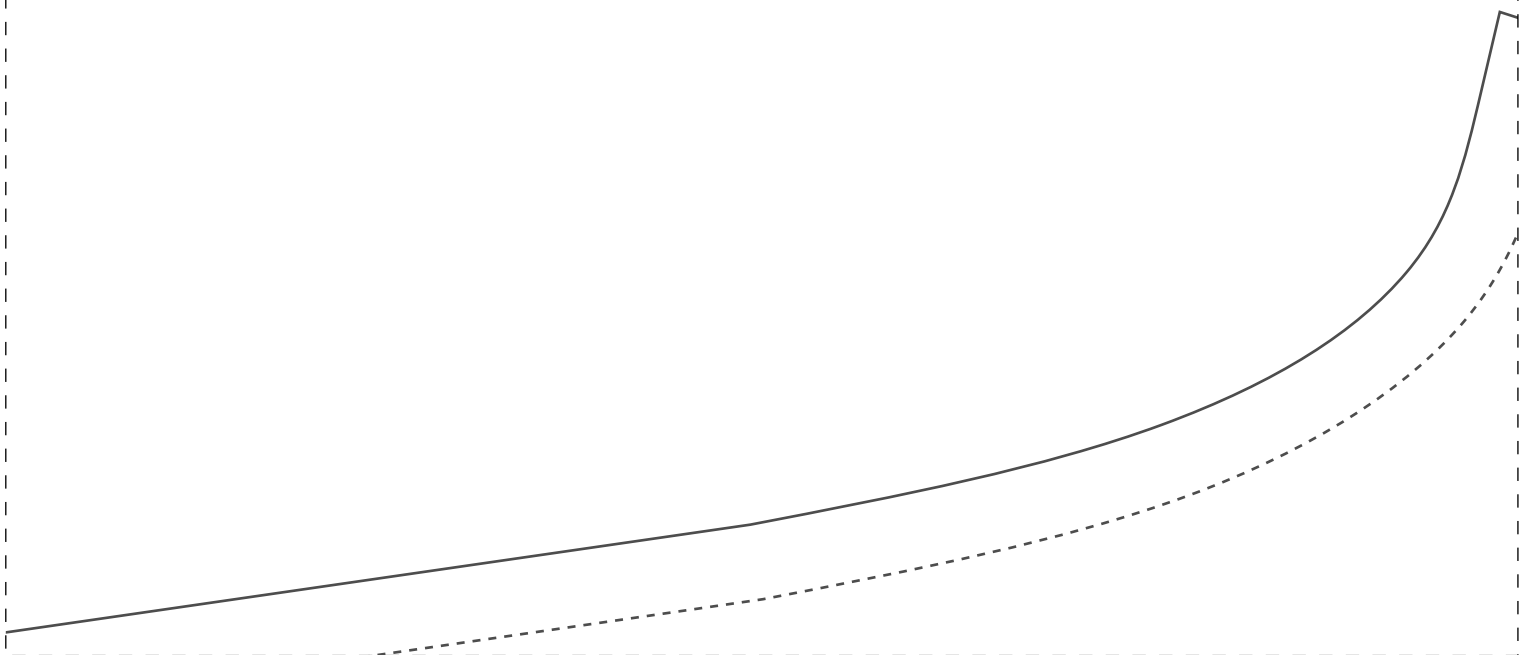

2-7

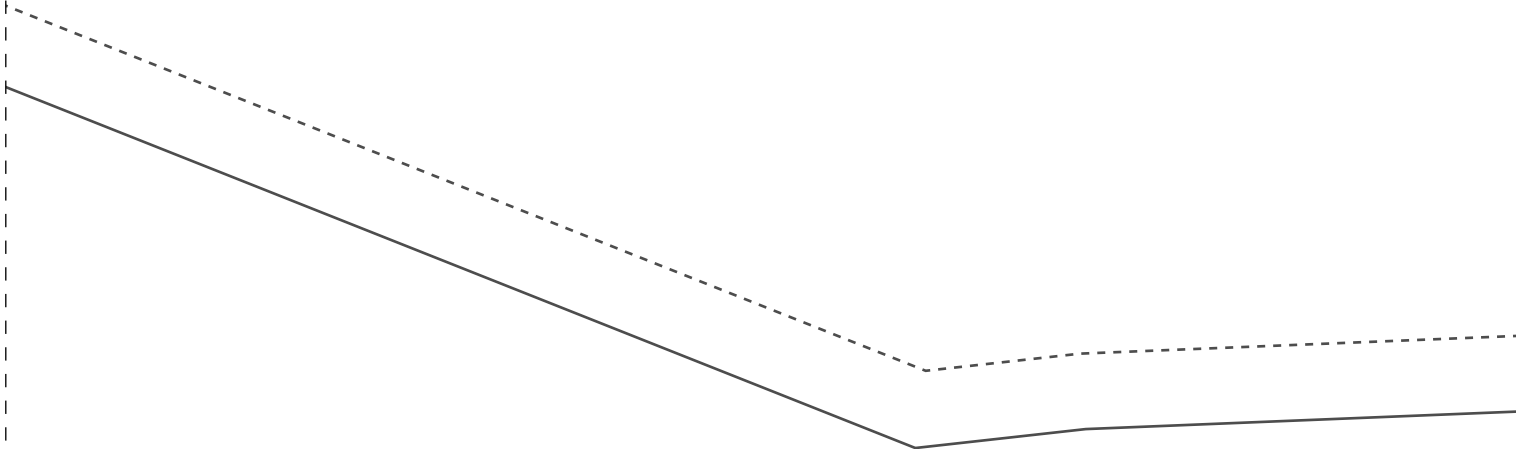

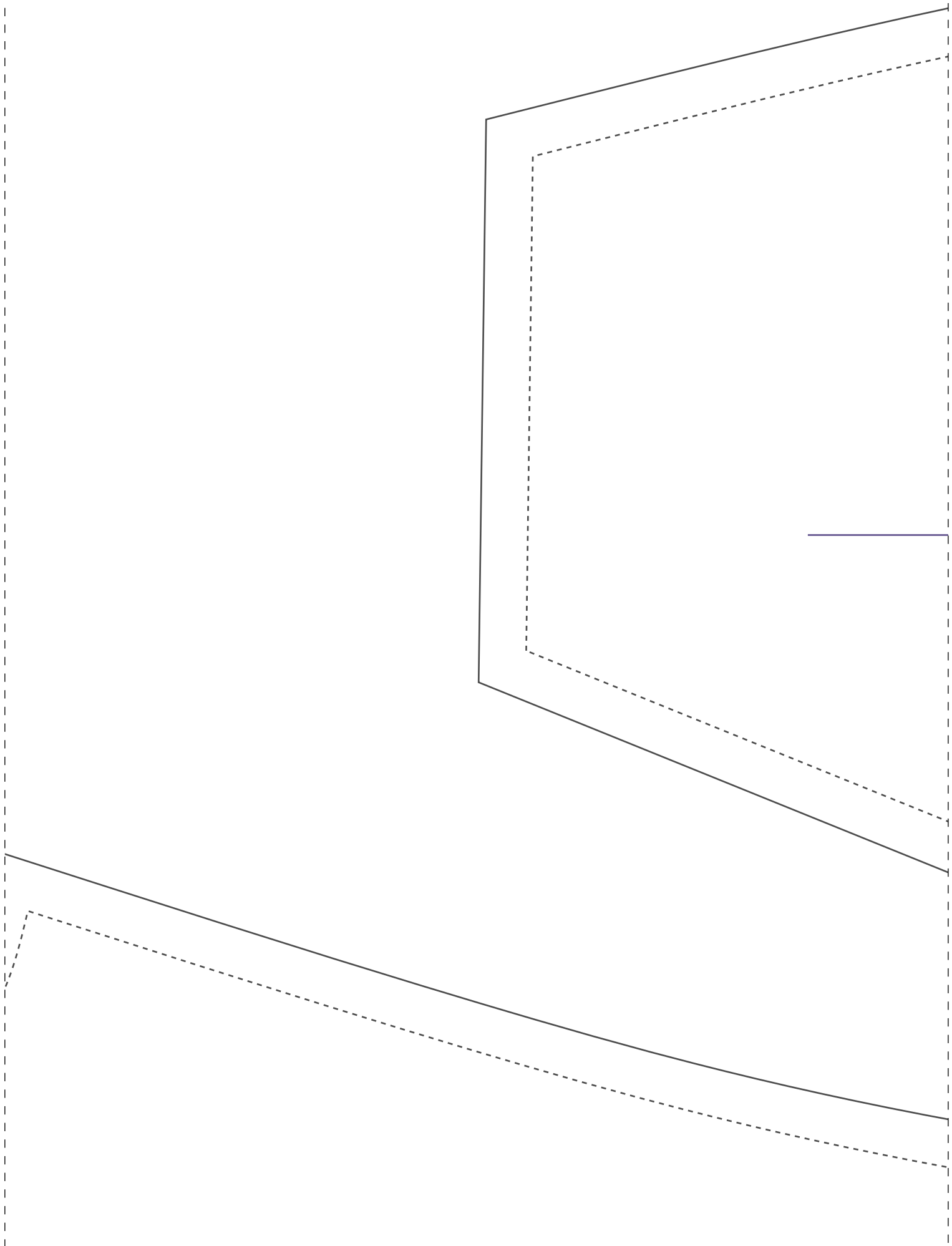

Instituto Diana Demarchi
Curso de Uniformes da Saúde
Calça Pijama Cirúrgico
Masculino

PROIBIDA REVENDA

1-9

BOLSO 2X
38

IDDS05

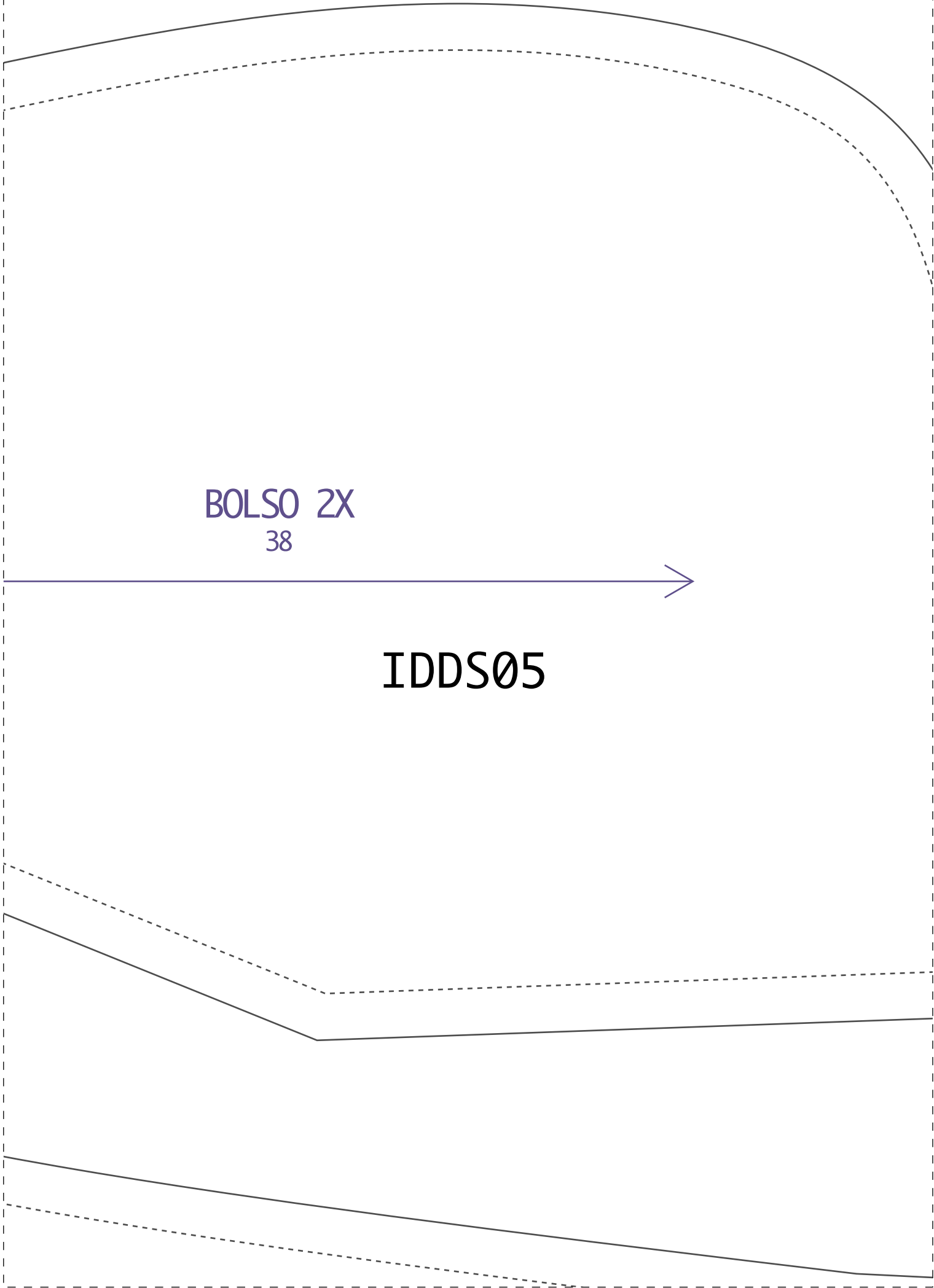

DIANTEIRO 2X
38

IDDS05

1-10

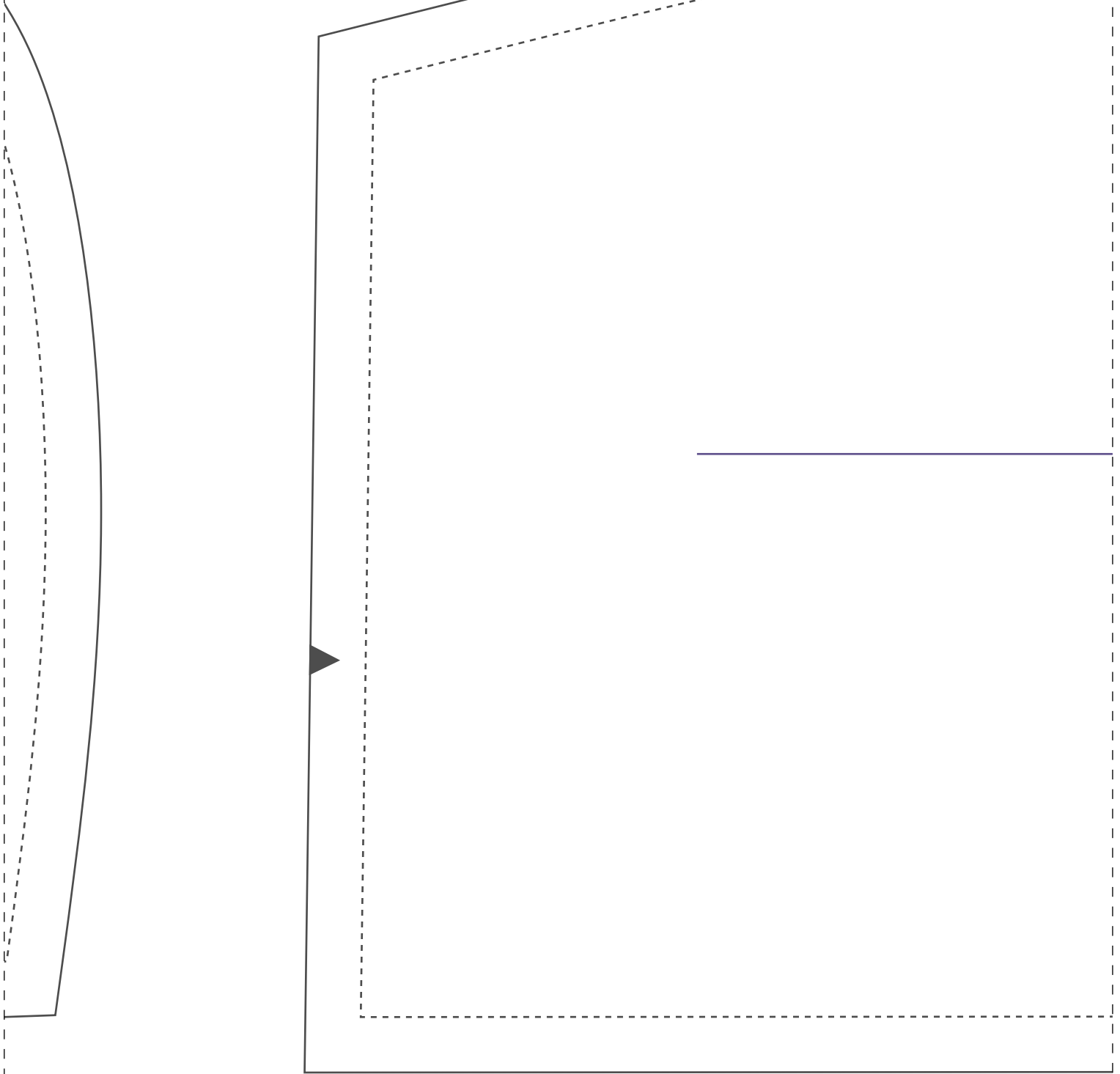

2-10



1-11

ESP/BOLSO 2X
38

IDDS05

