

Teste de impressão: ao imprimir seu molde, meça o quadrado que deverá ter a mesma medida informada (4cm), assim você se certificará que ele foi impresso no tamanho correto.

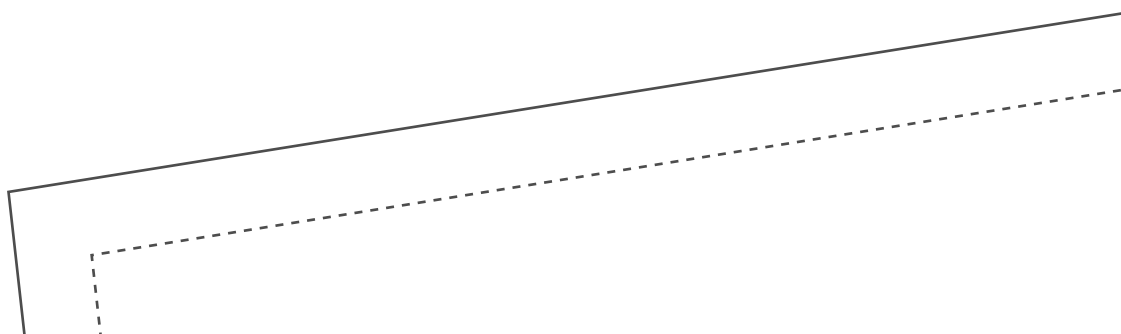

2-1

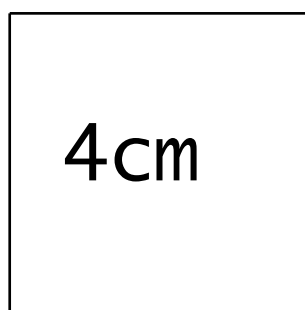

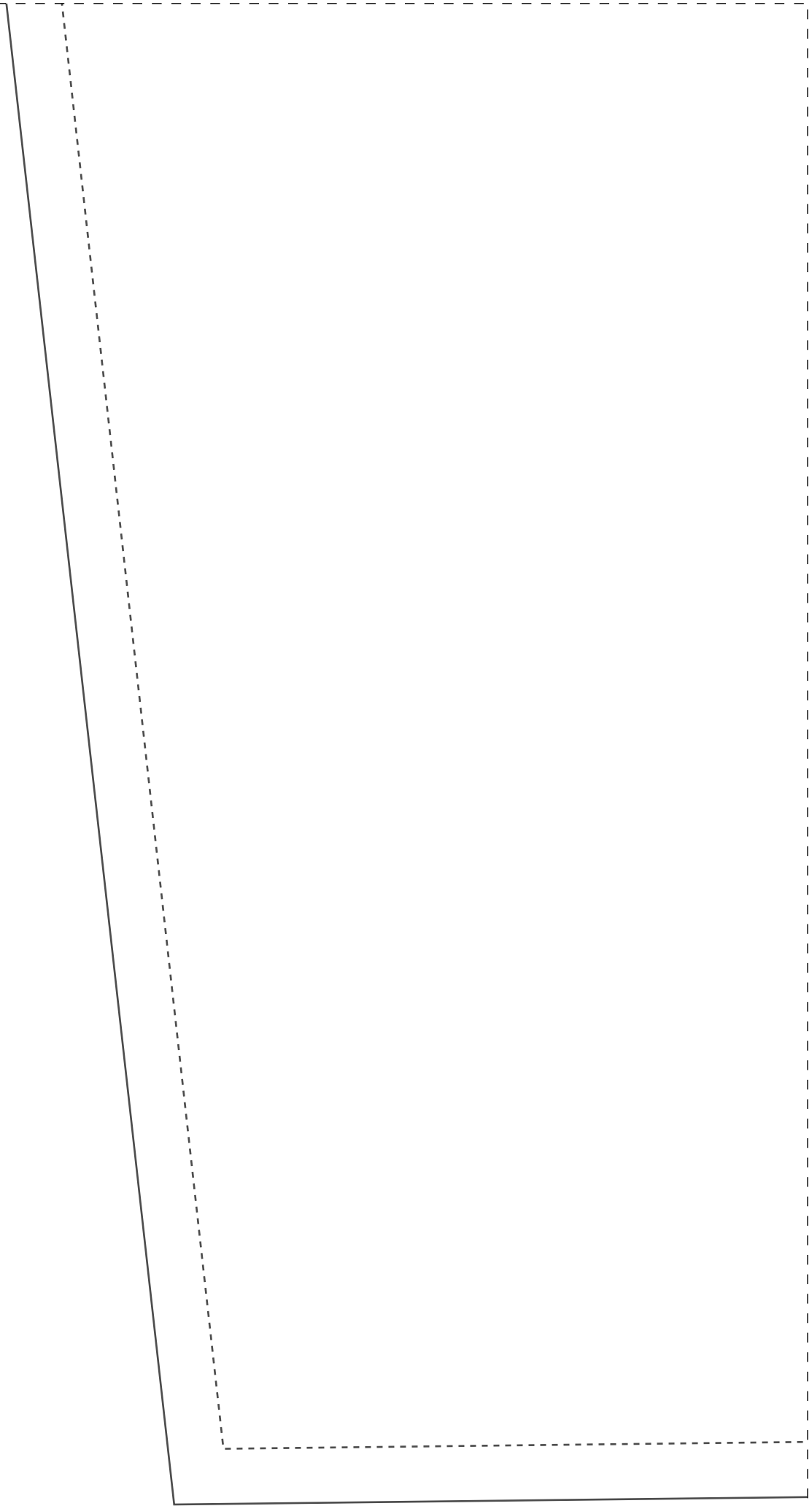
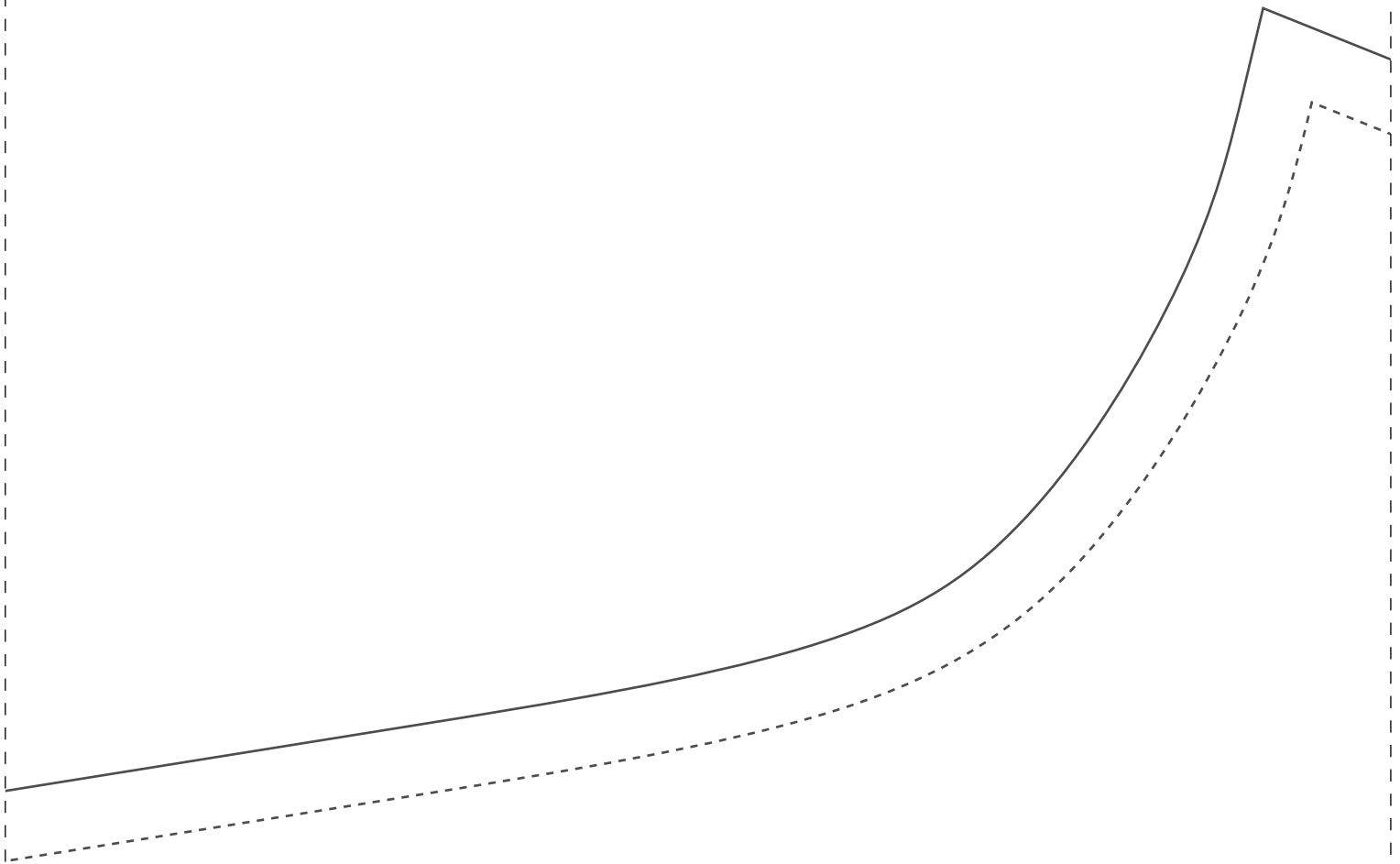

FICHA TÉCNICA:

Tecido Plano 1,4m larg

-Crepe Flow, Oxfordine,
Gabardine, brim leve ou similares

-Cós com elástico 4cm,
cortar elástico com:

36: 72cm / 38: 74cm / 40: 76cm

42: 78cm / 44: 80cm / 46: 82cm

48: 84cm / 50: 86cm / 52: 88cm

54: 90cm

-2,3m do 36 ao 44

-2,5m do 46 ao 54

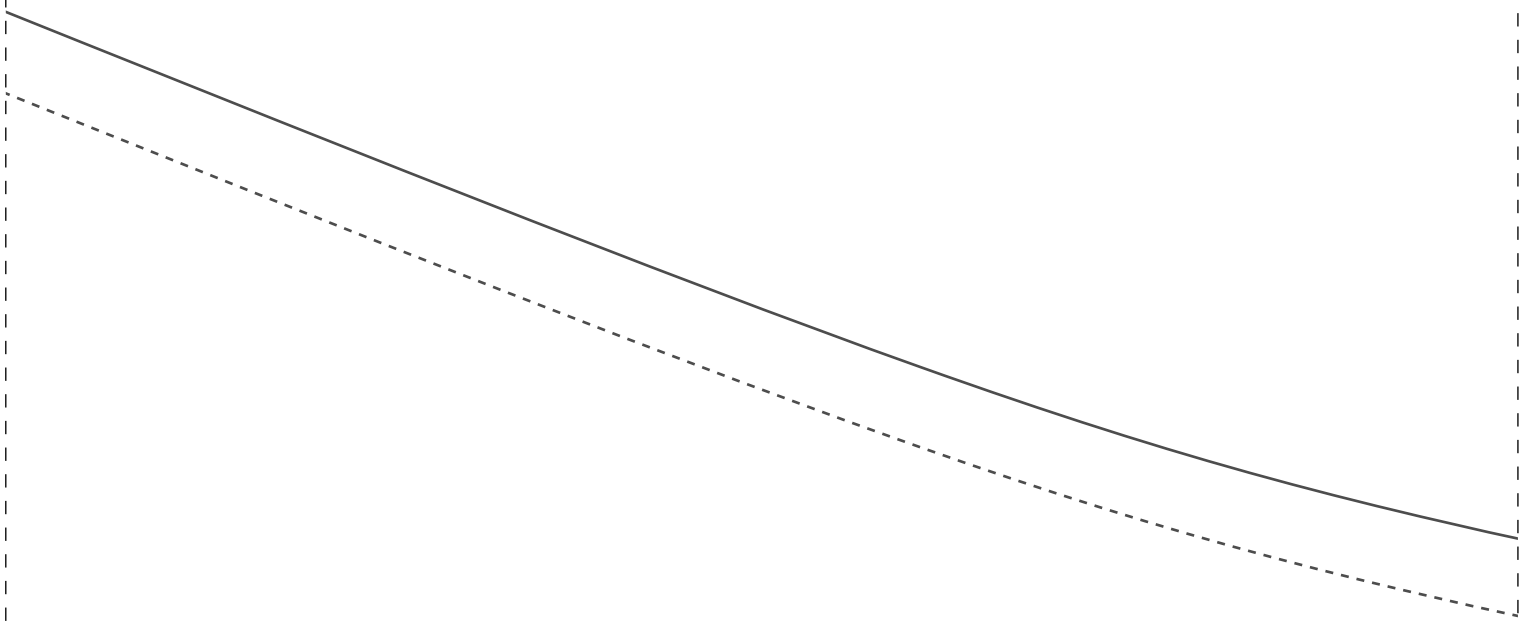



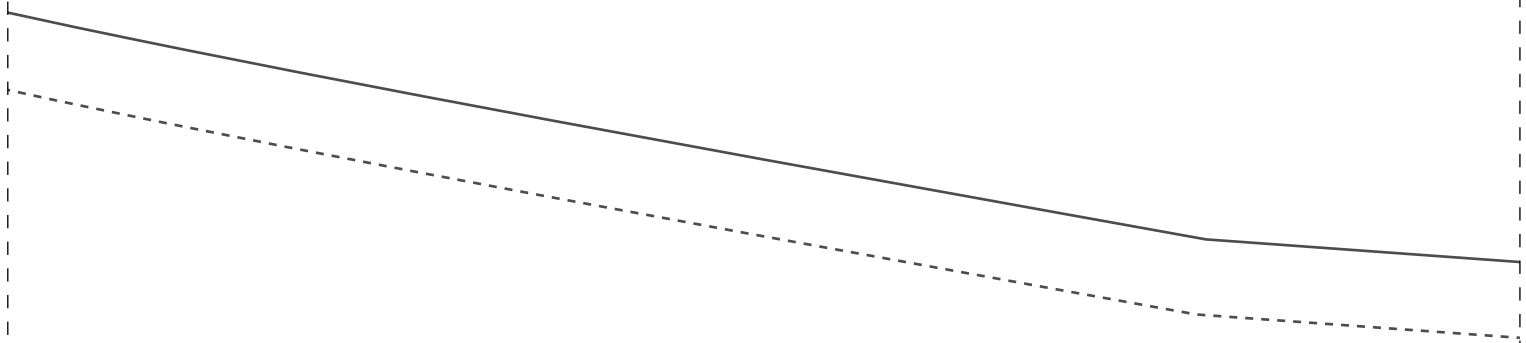

TRASEIRO 2X
46

IDDS05

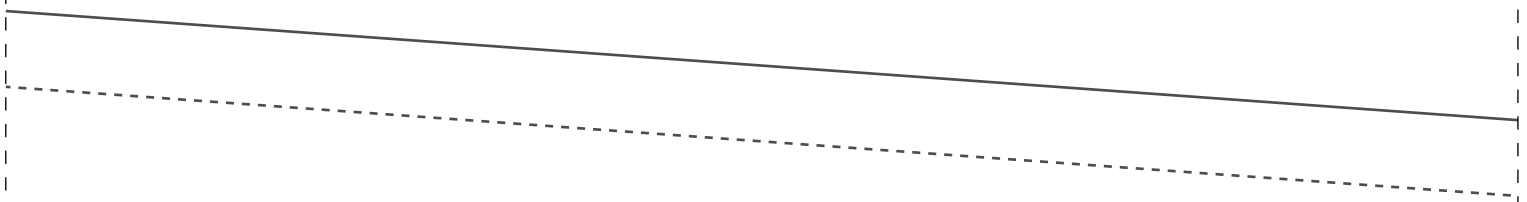



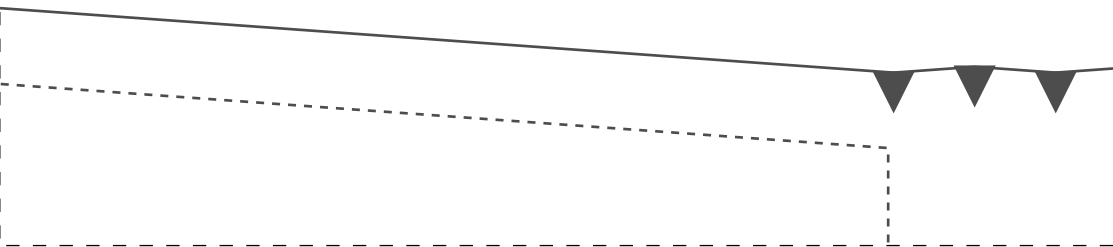
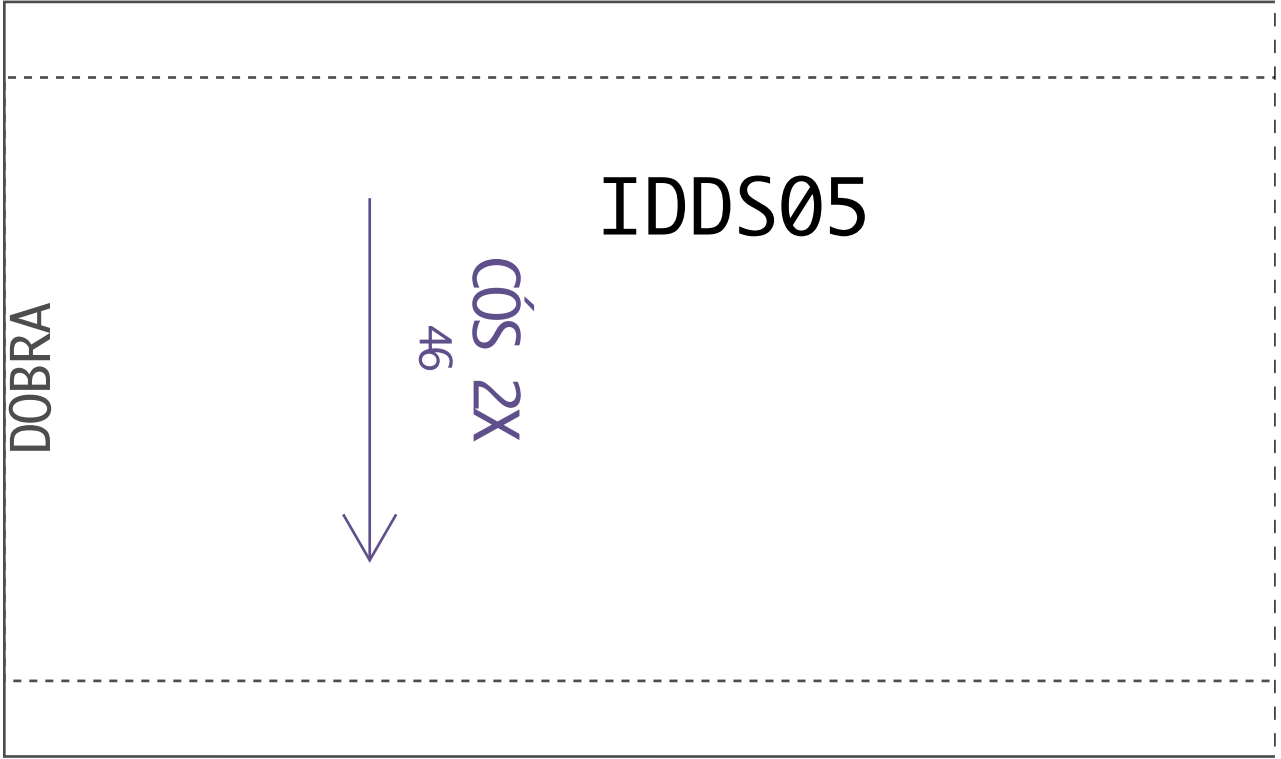

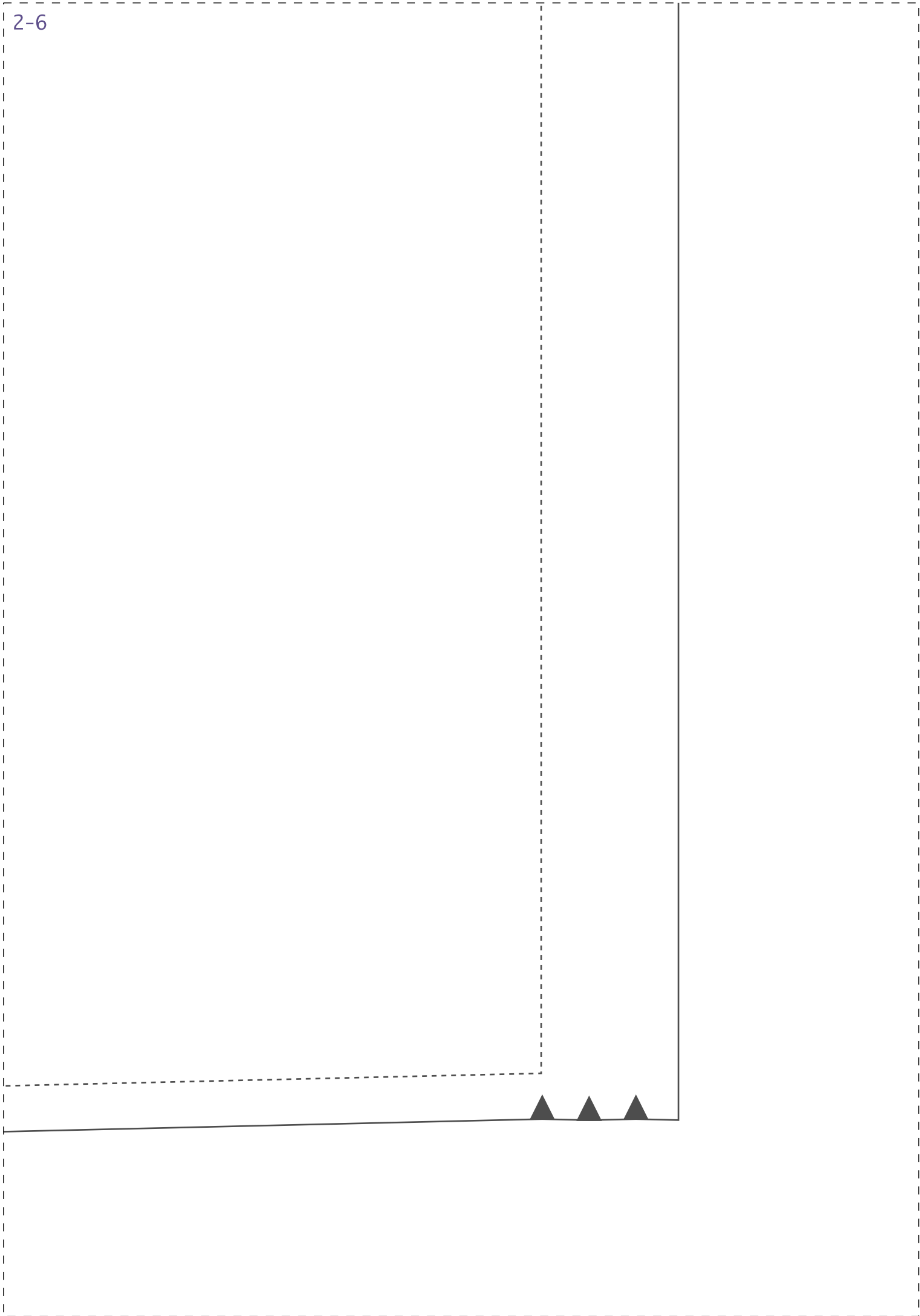

1-7

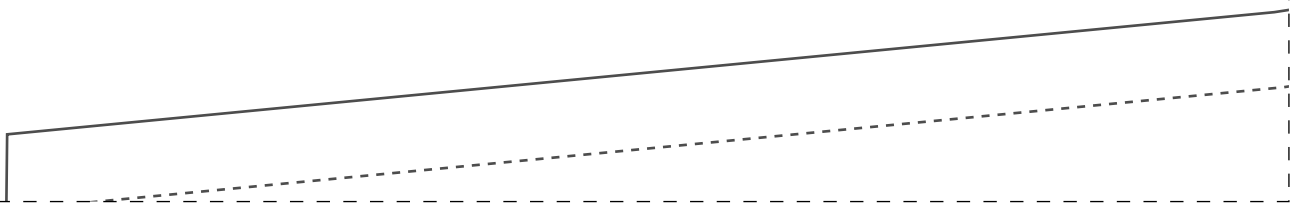

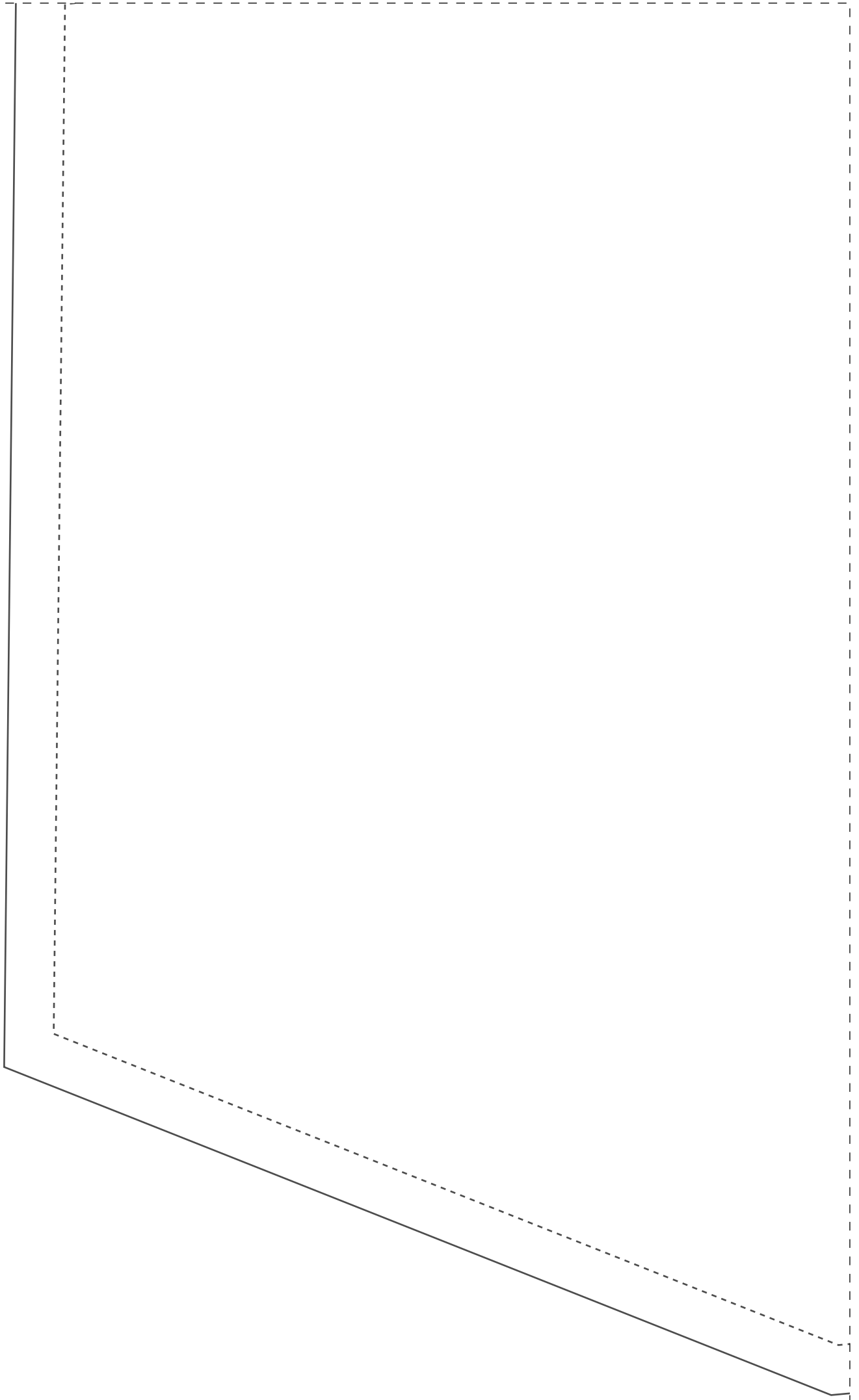

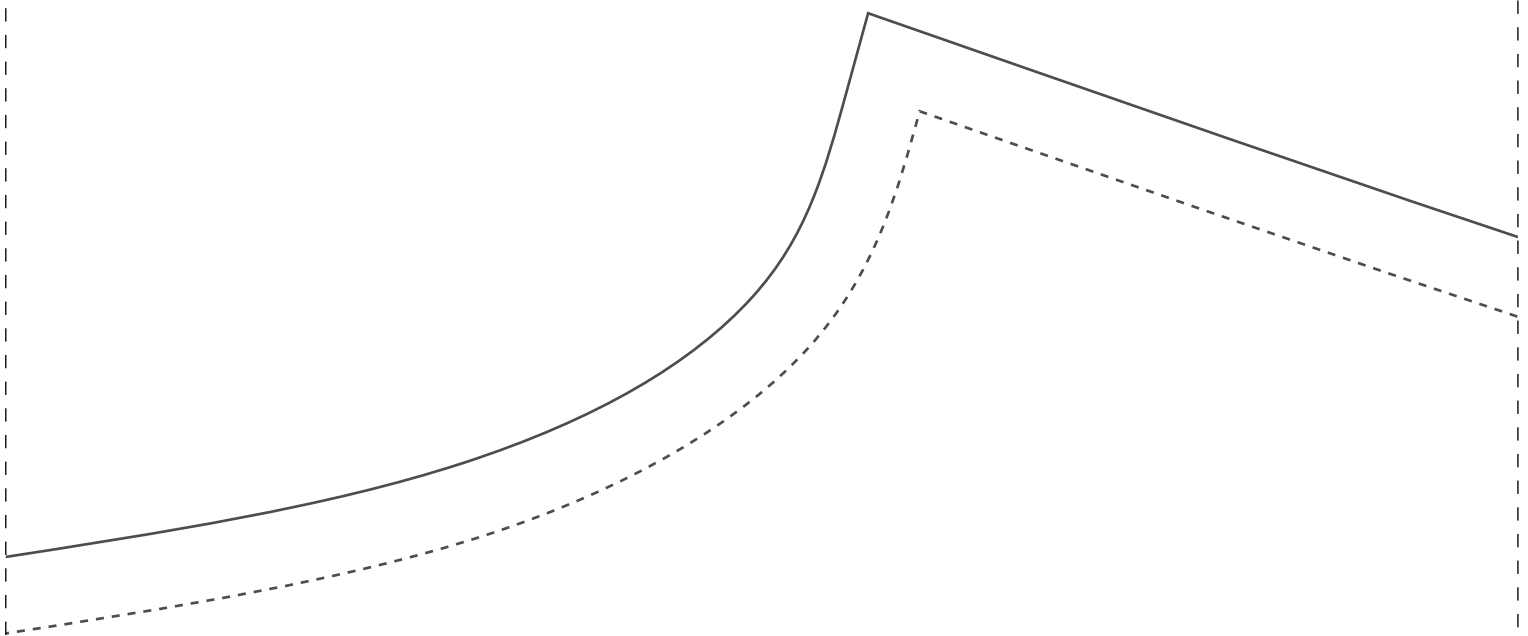

Instituto Diana Demarchi
Curso de Uniformes da Saúde
Calça Pijama Cirúrgico
Masculino

PROIBIDA REVENDA

DIANTEIRO 2X

46

1-10

BOLSO 2X
46

IDDS05

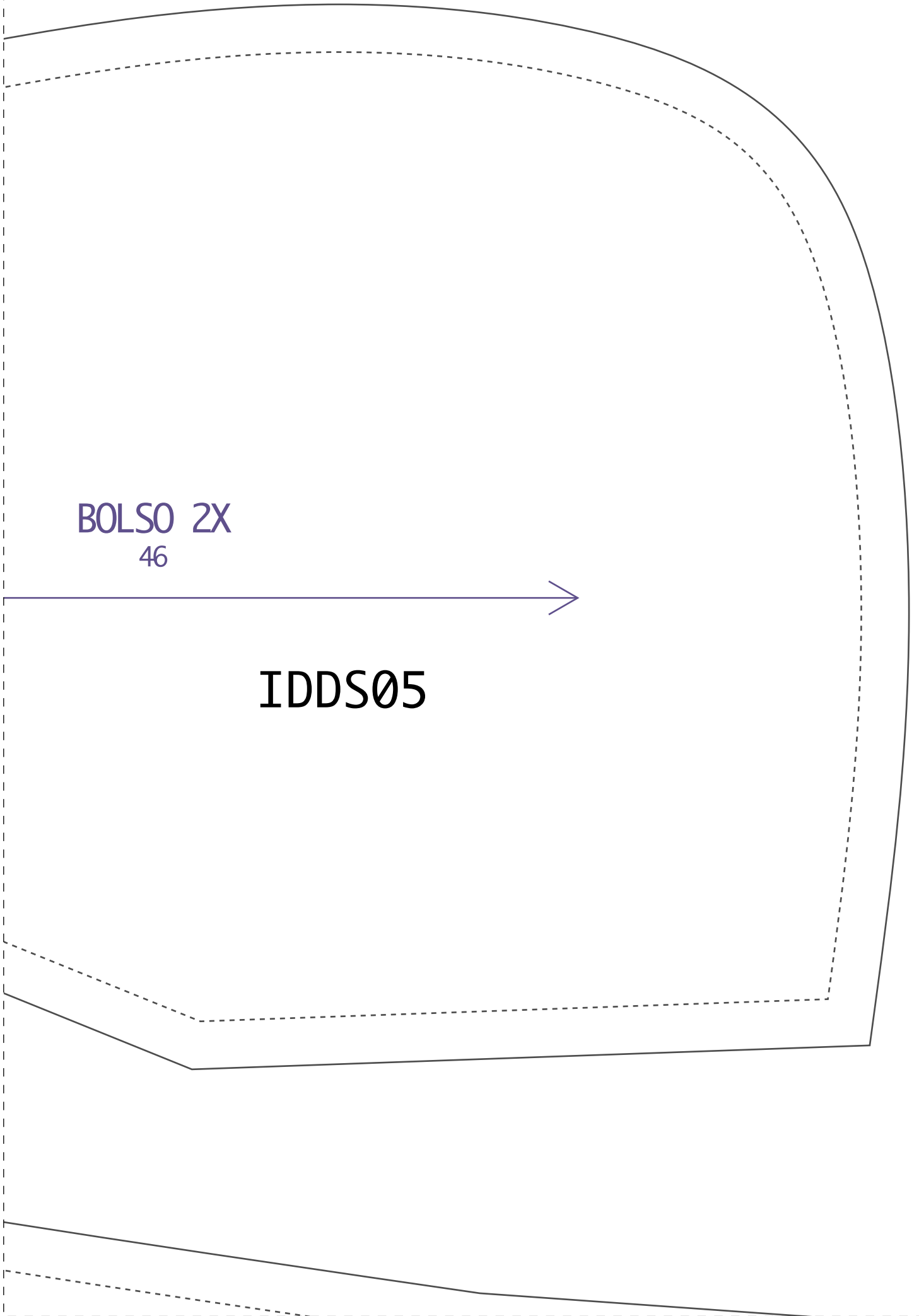

IDDS05

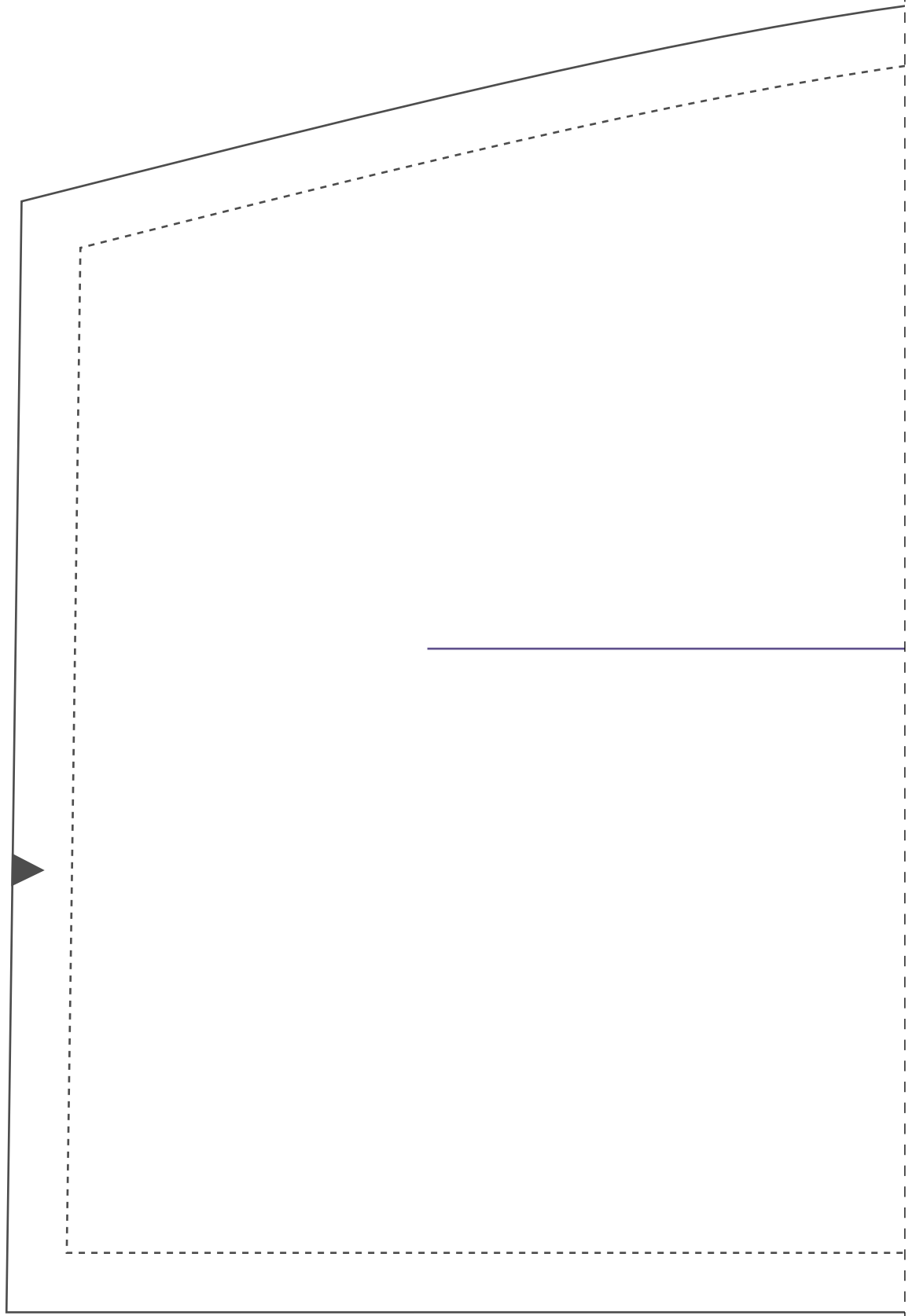

2-11



1-12

ESP/BOLSO 2X
46

IDDS05

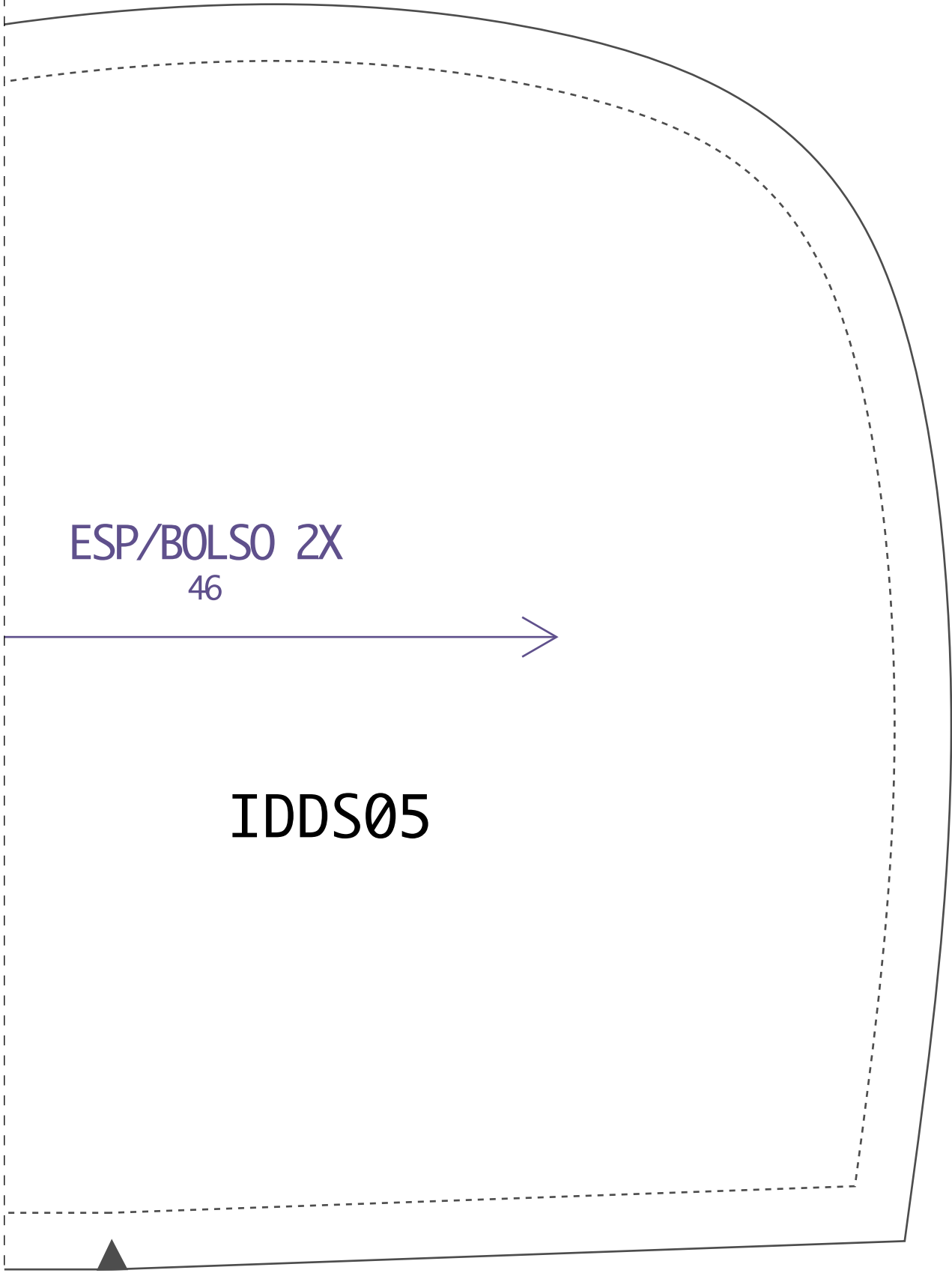

2-12

