

1-1

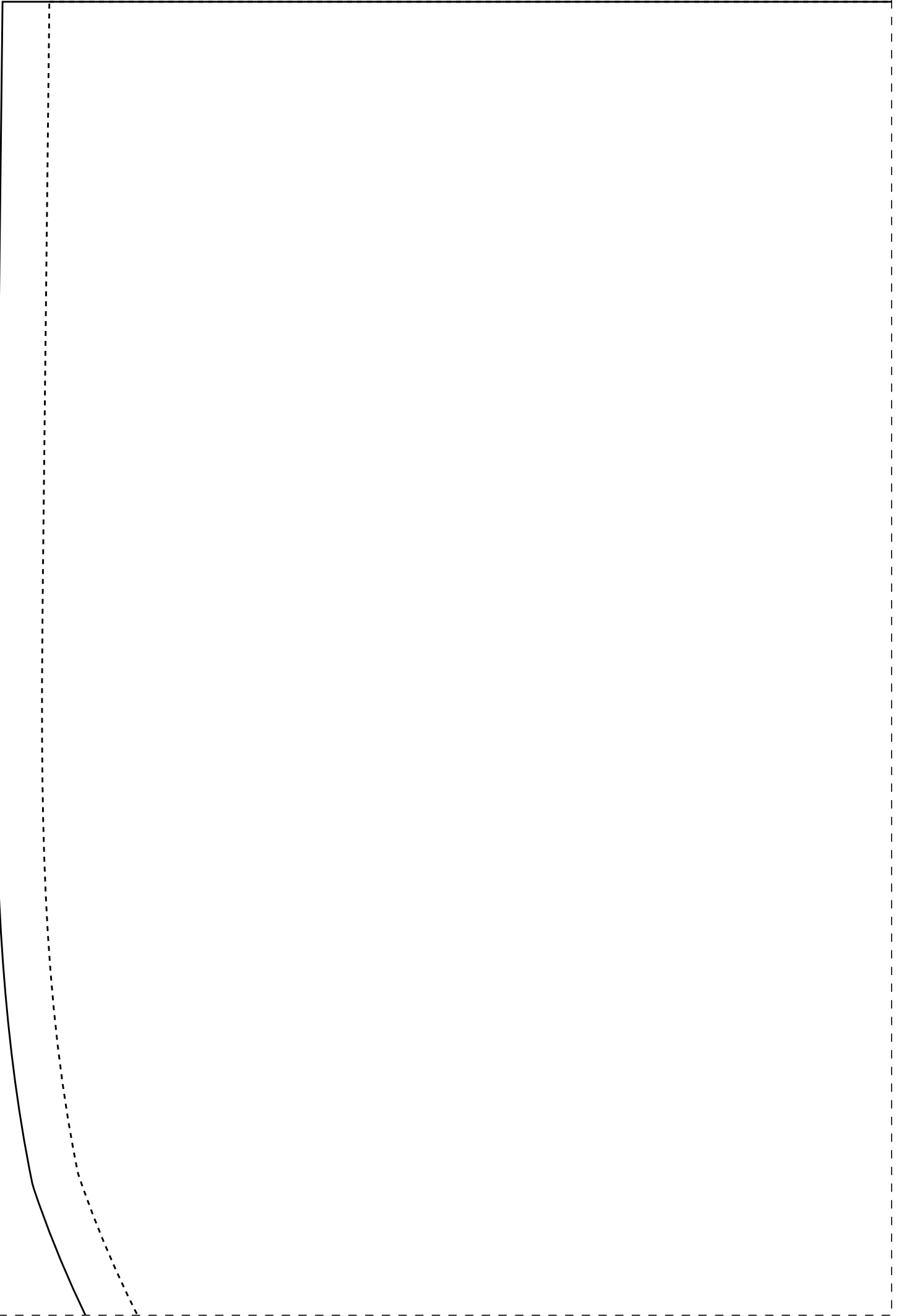

2-1

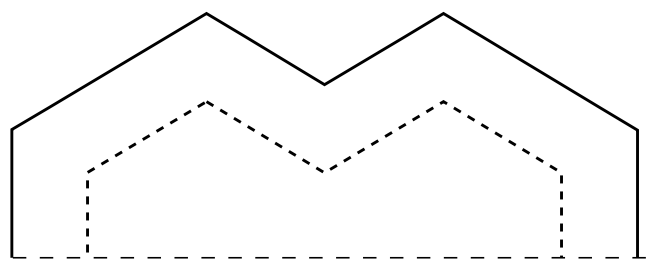
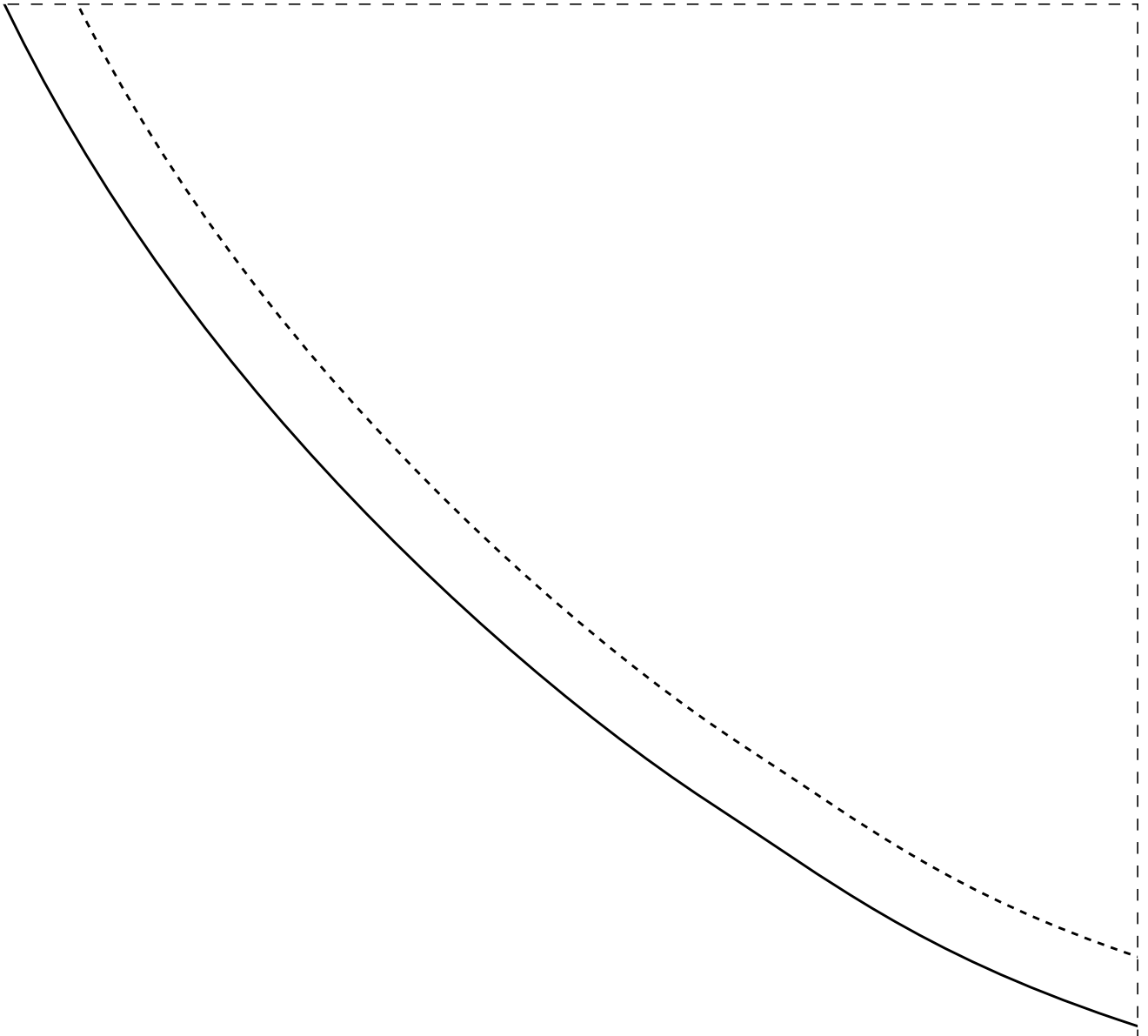

MARTINGALE 2X-52

IDD33



dobra

IDD33



GOLA 2X-52

4-1

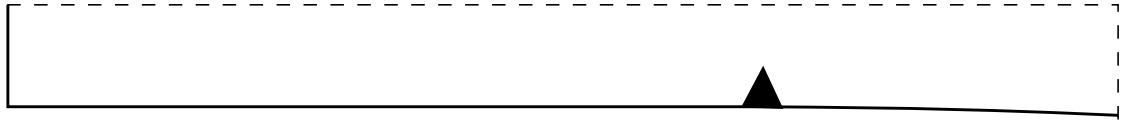



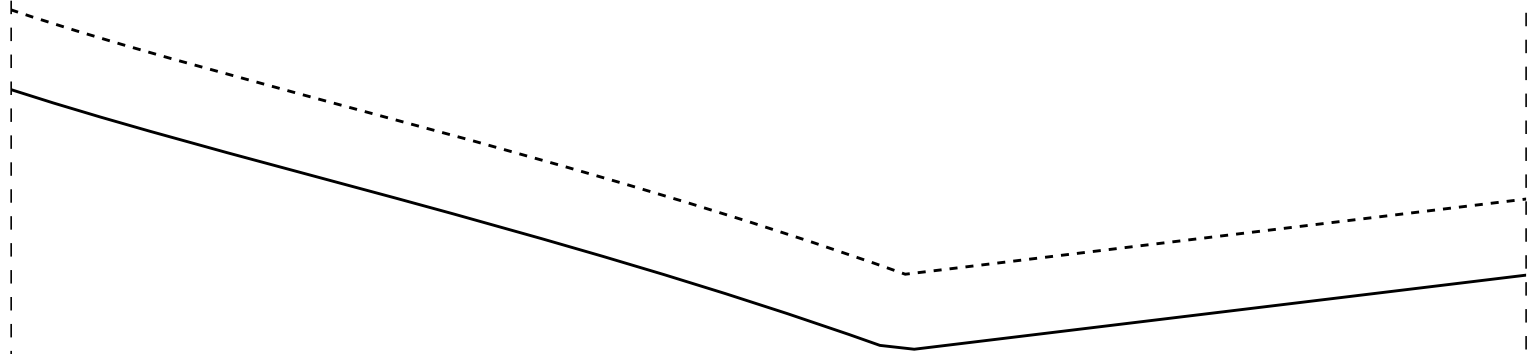

3-2

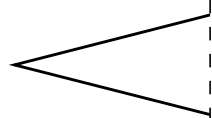
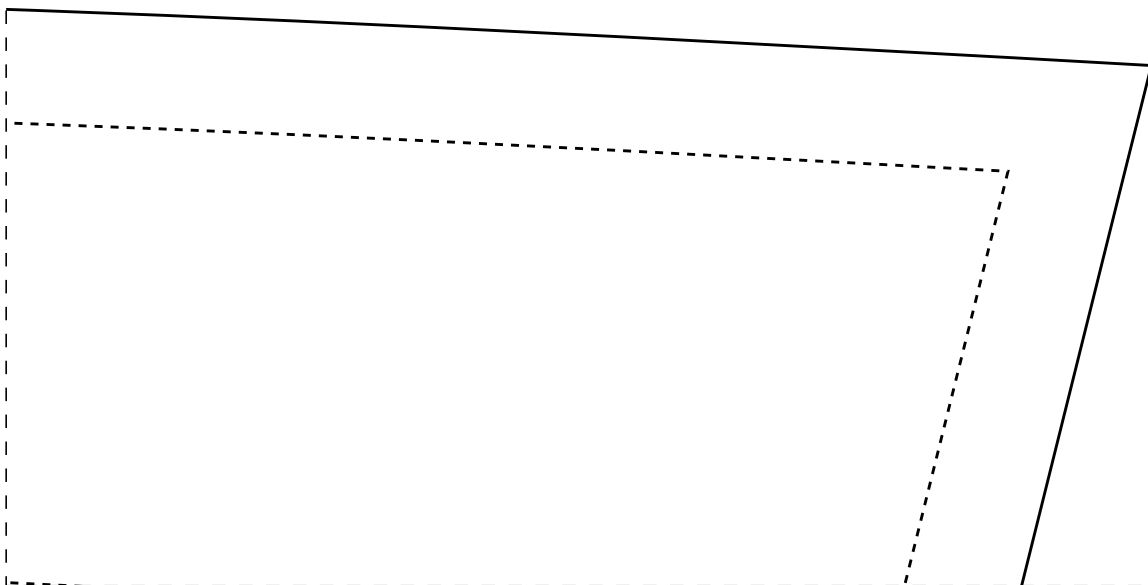

4-2





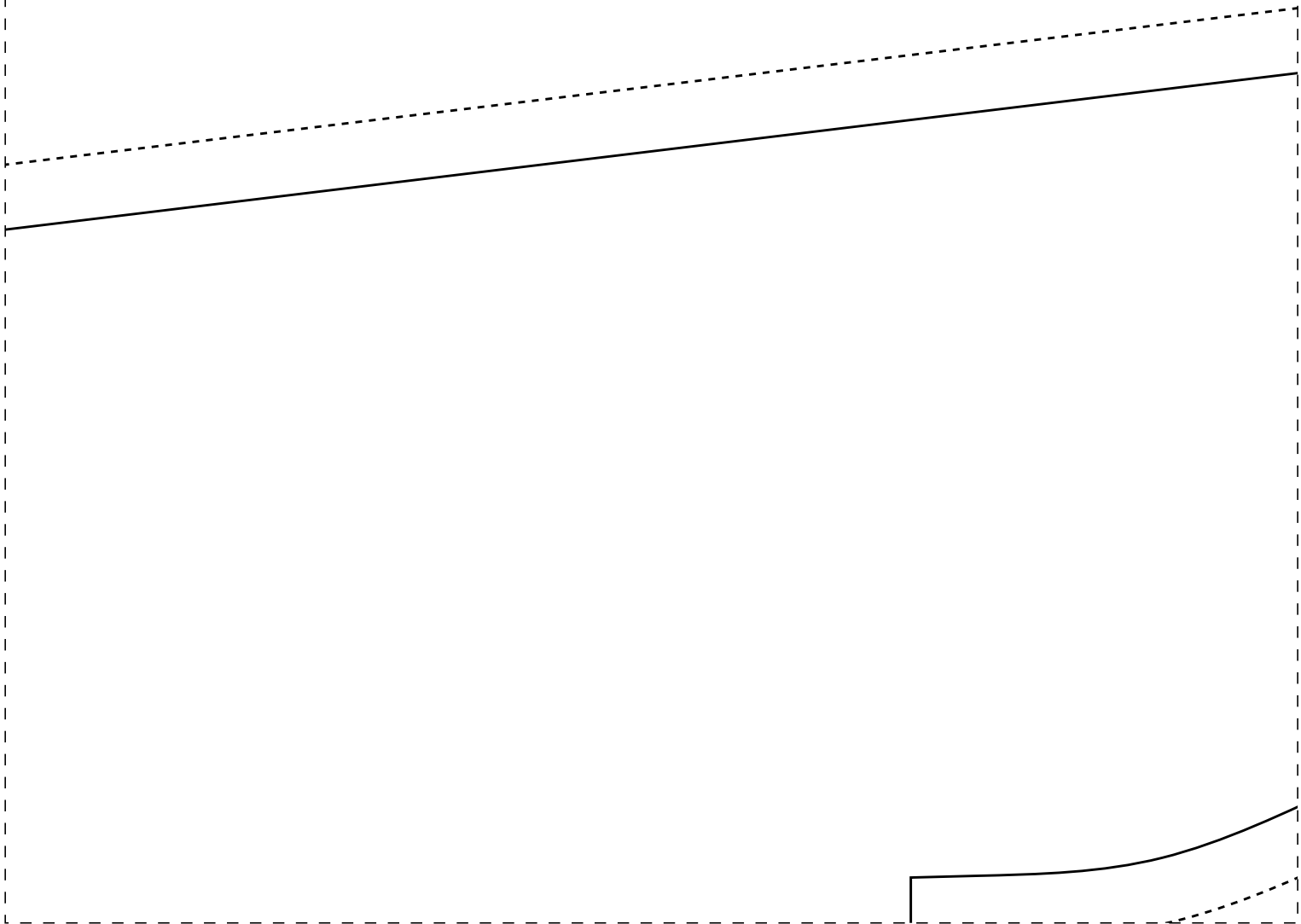

IDD33

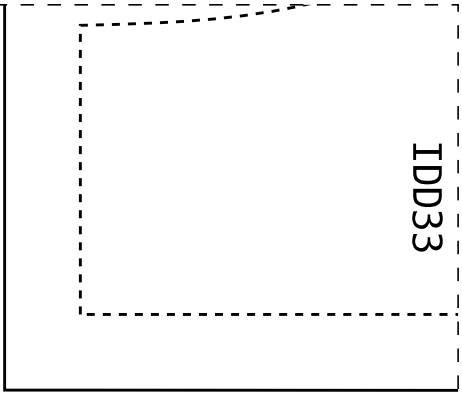

punho 2x-52



IDD33

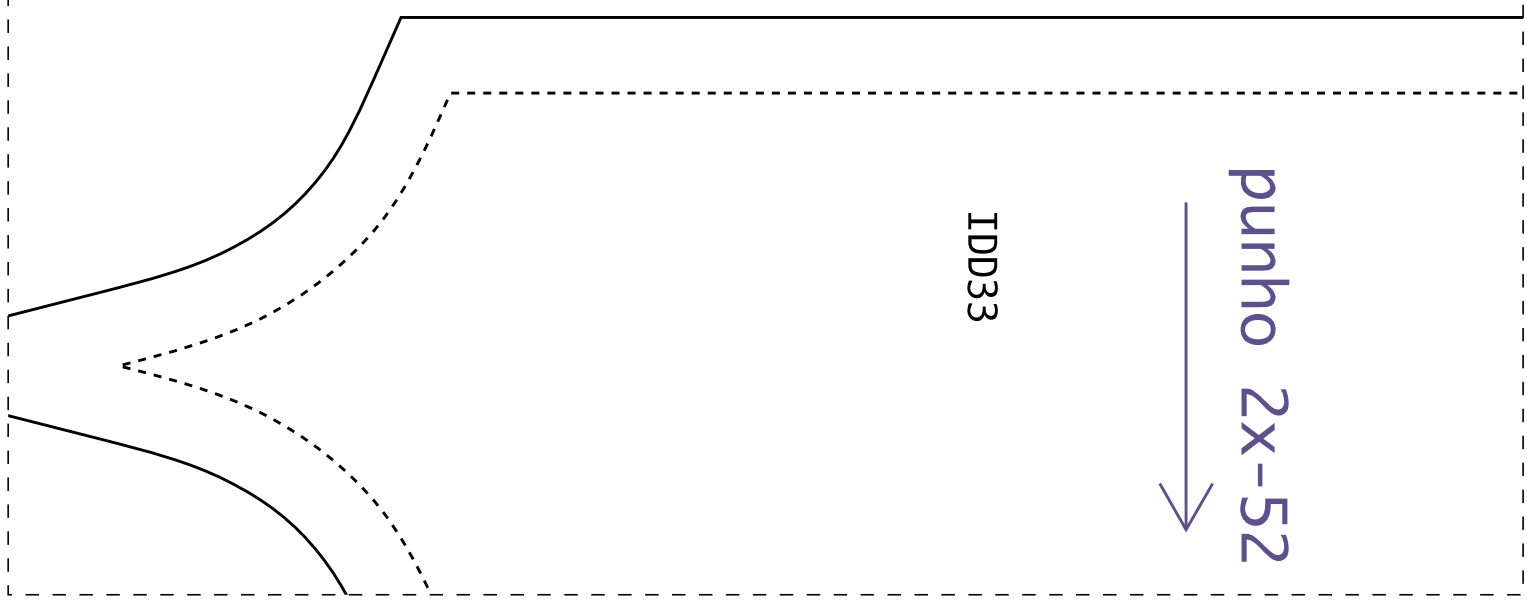

3-3





2-4

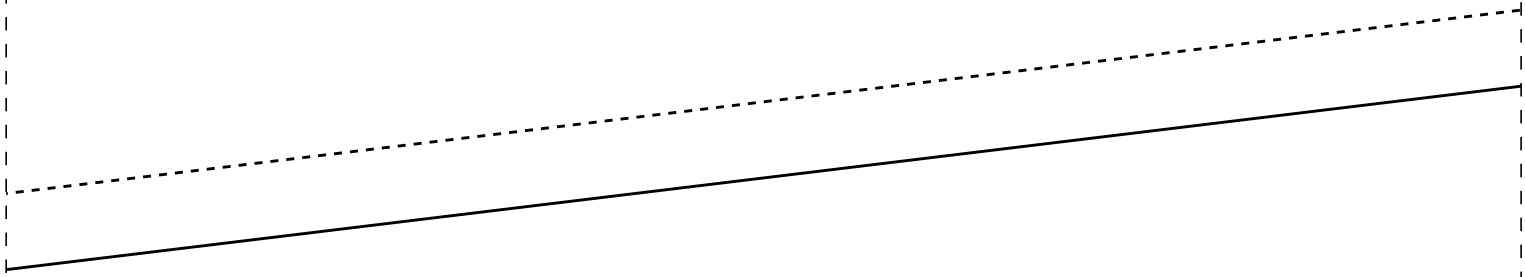

-52

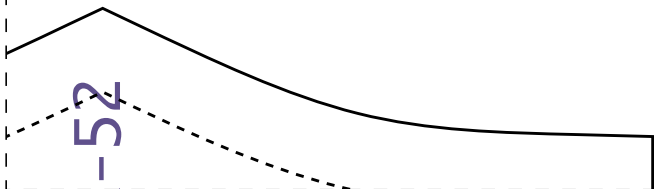

3-4  
LAPELA 4X



dobro

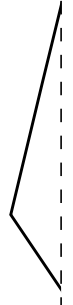





1-5

dobra

0

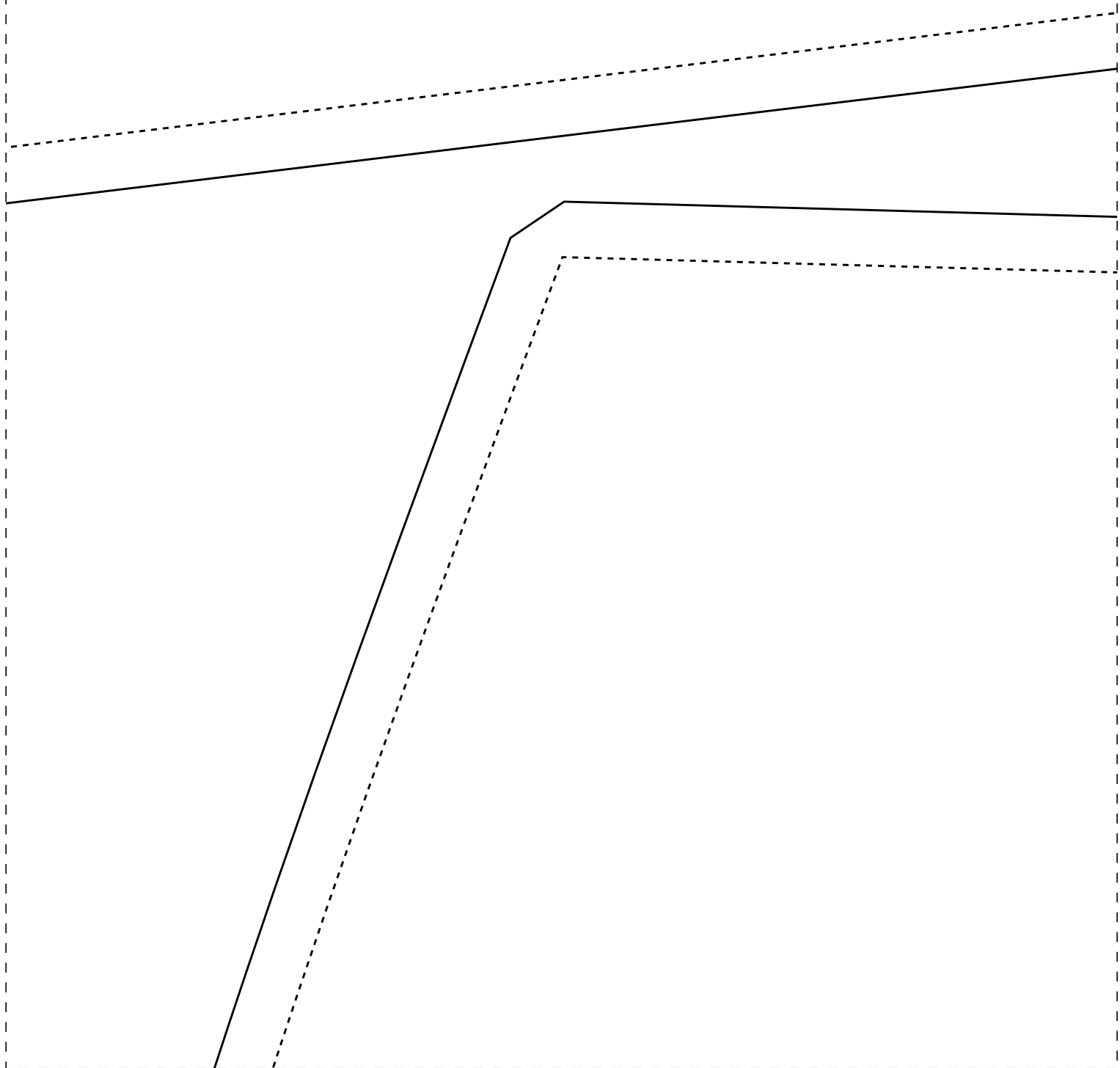

3-5

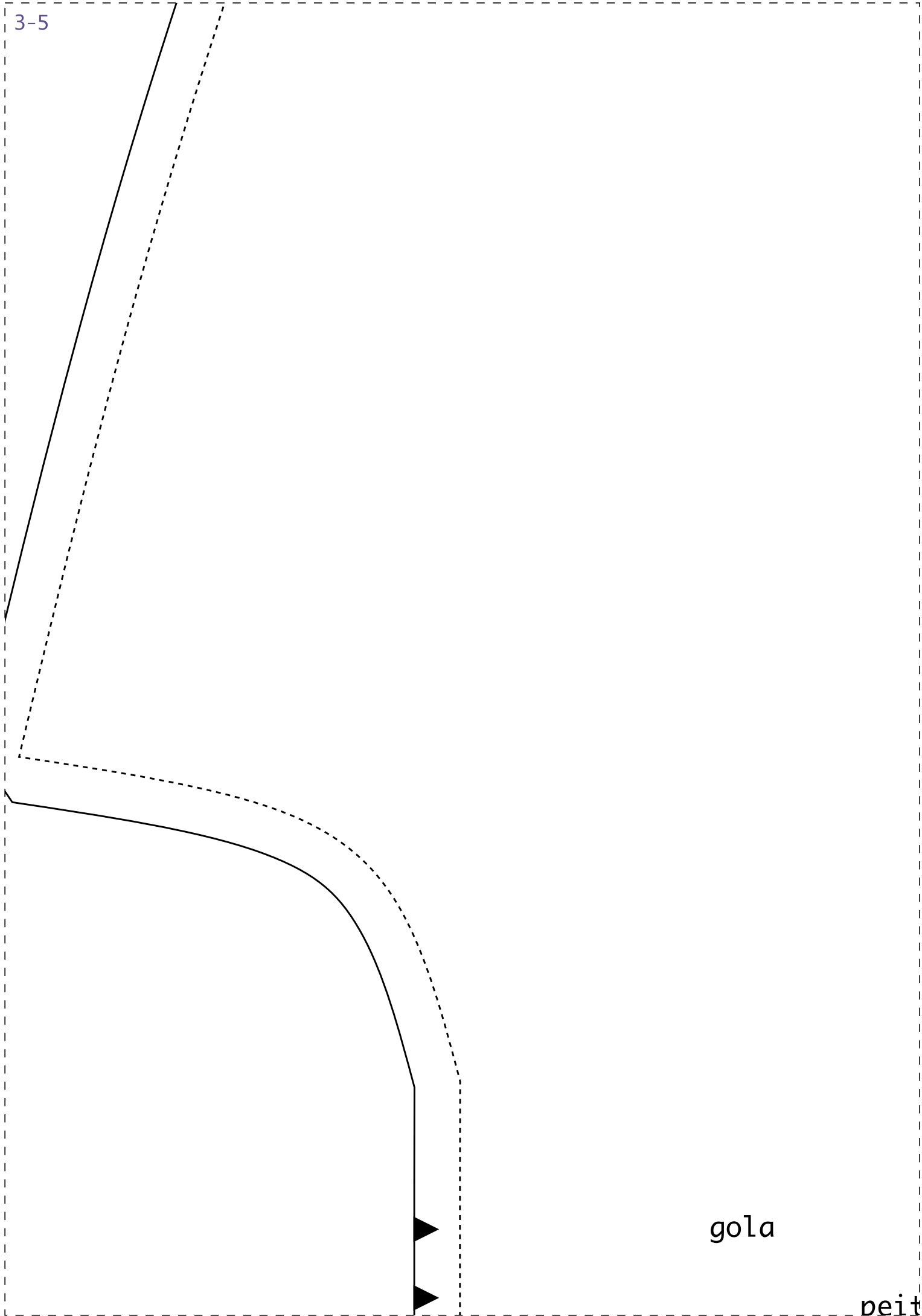

gola

peit

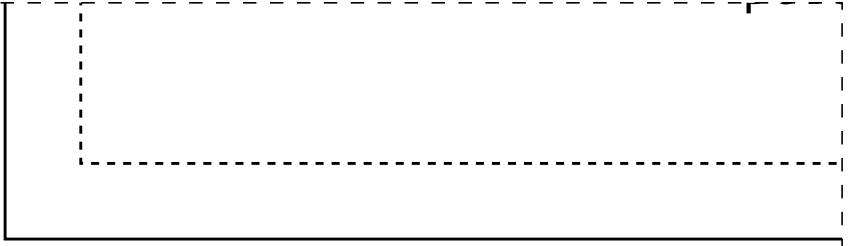



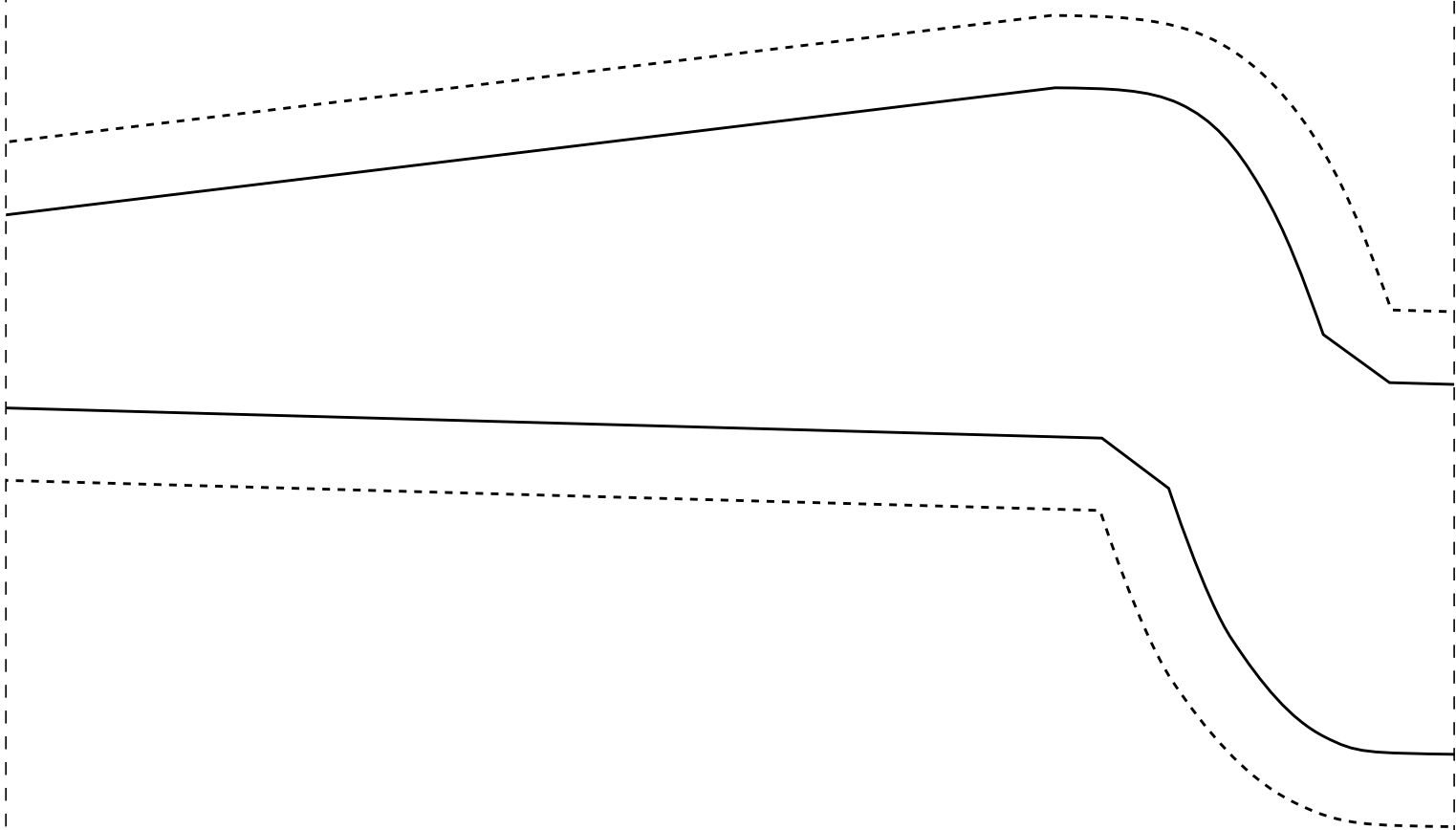

Lapela/bolso

---





\_\_\_\_\_

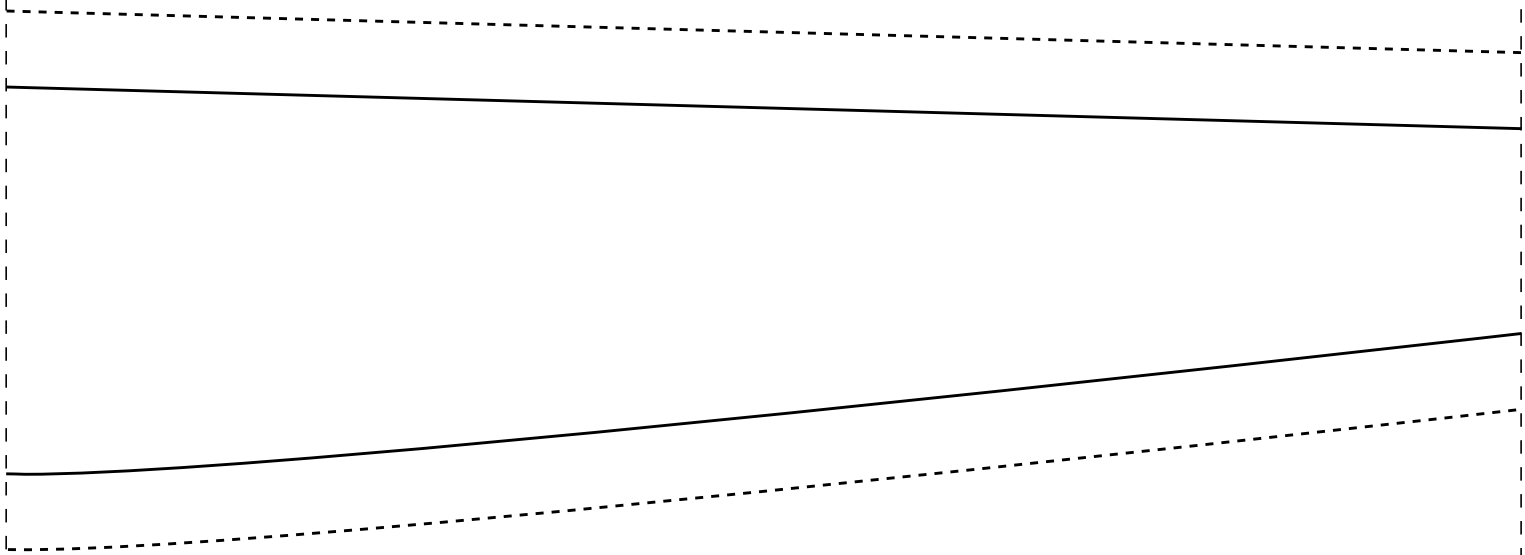

IDD33

---



1-8

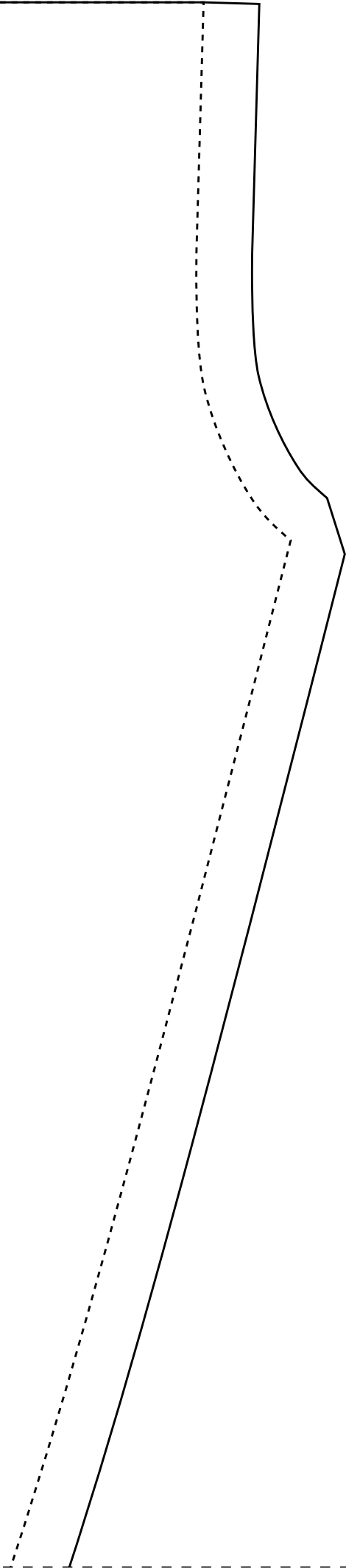

2-8

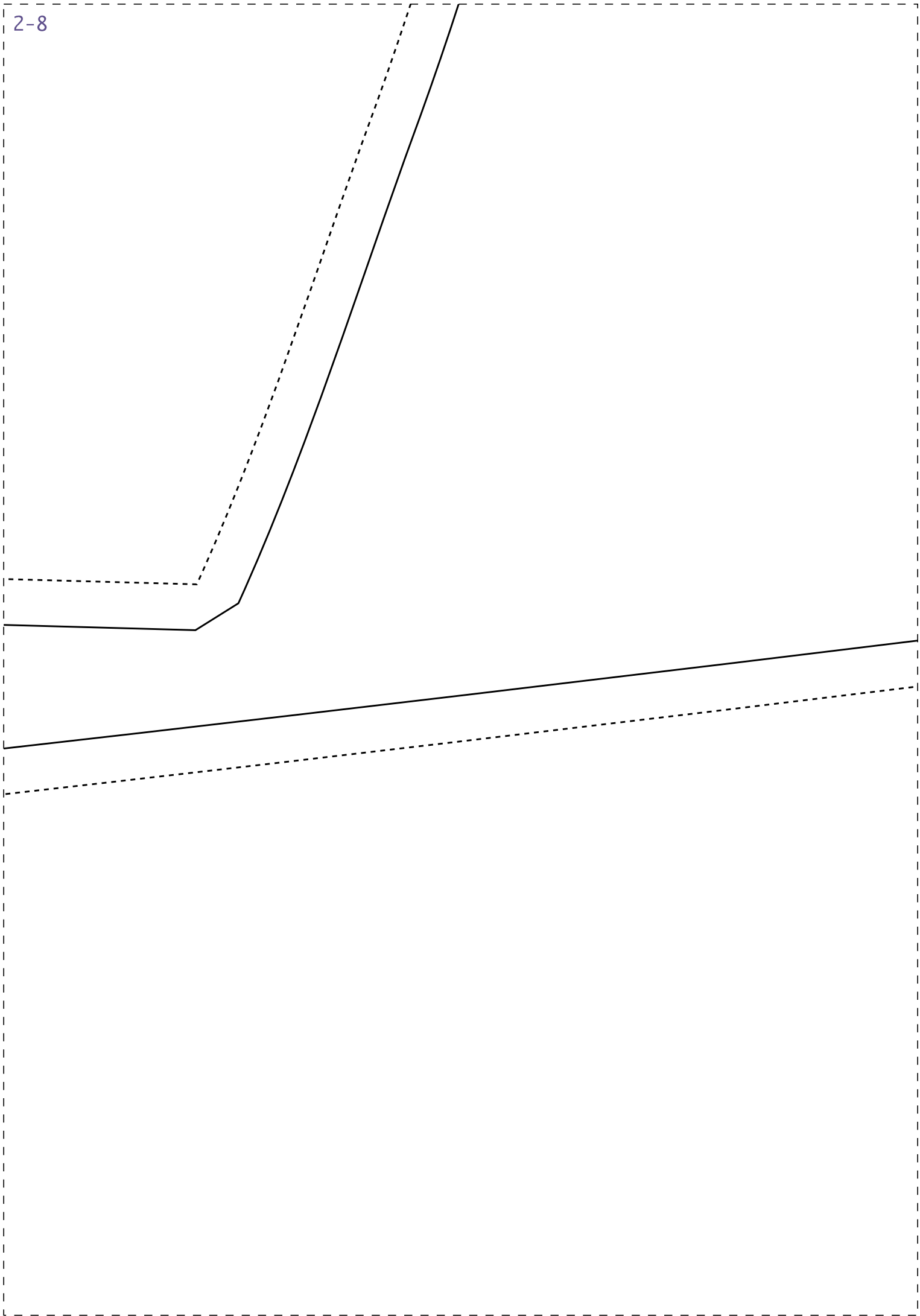

## FRENTE 2X-52

---

### FICHA TÉCNICA:

- Tecido plano 1,4m de largura
- Viscolinho, linho, viscose ou similares
- Peça com martingale, bolso e lapela
- Manga com punho
- Peitilho dobrado na peça pronto com 2,5cm
- Fechamento com caseado e botões
- Bainha de lenço ou viés
- 3,3m para todos os tamanhos





Teste de impressão: ao imprimir seu molde, meça o quadrado que deverá ter a mesma medida informada (4cm), assim você se certificará que ele foi impresso no tamanho correto.

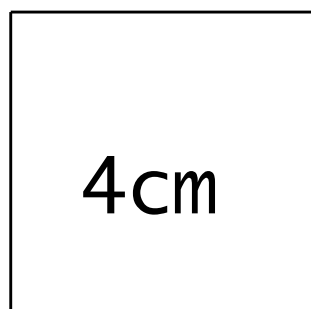

dok

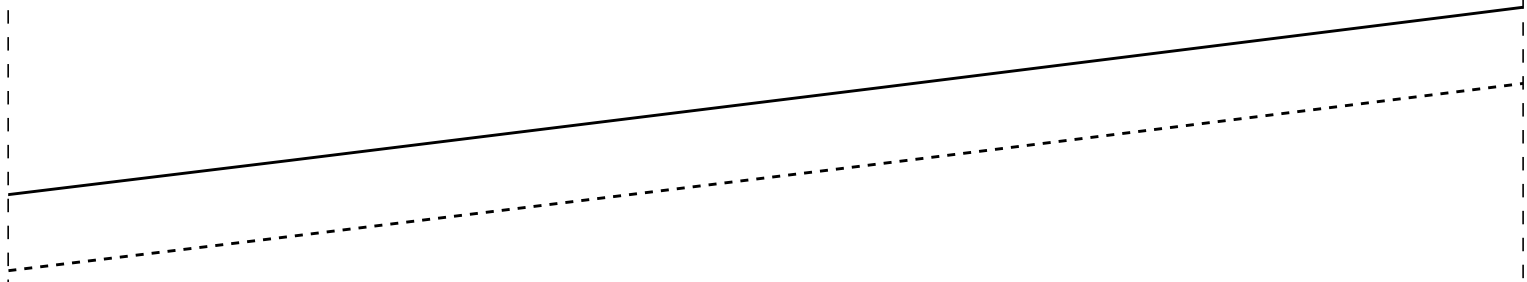







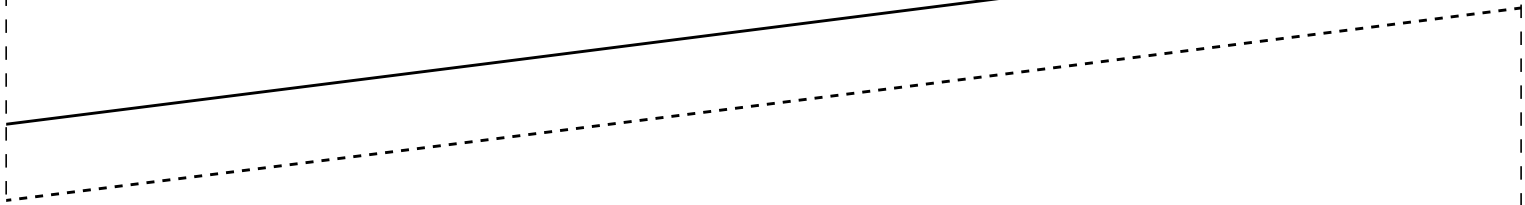
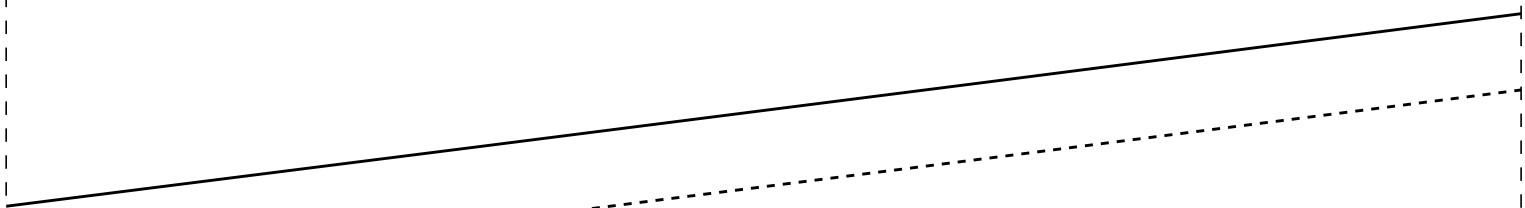









2-11

1X-52  
↓

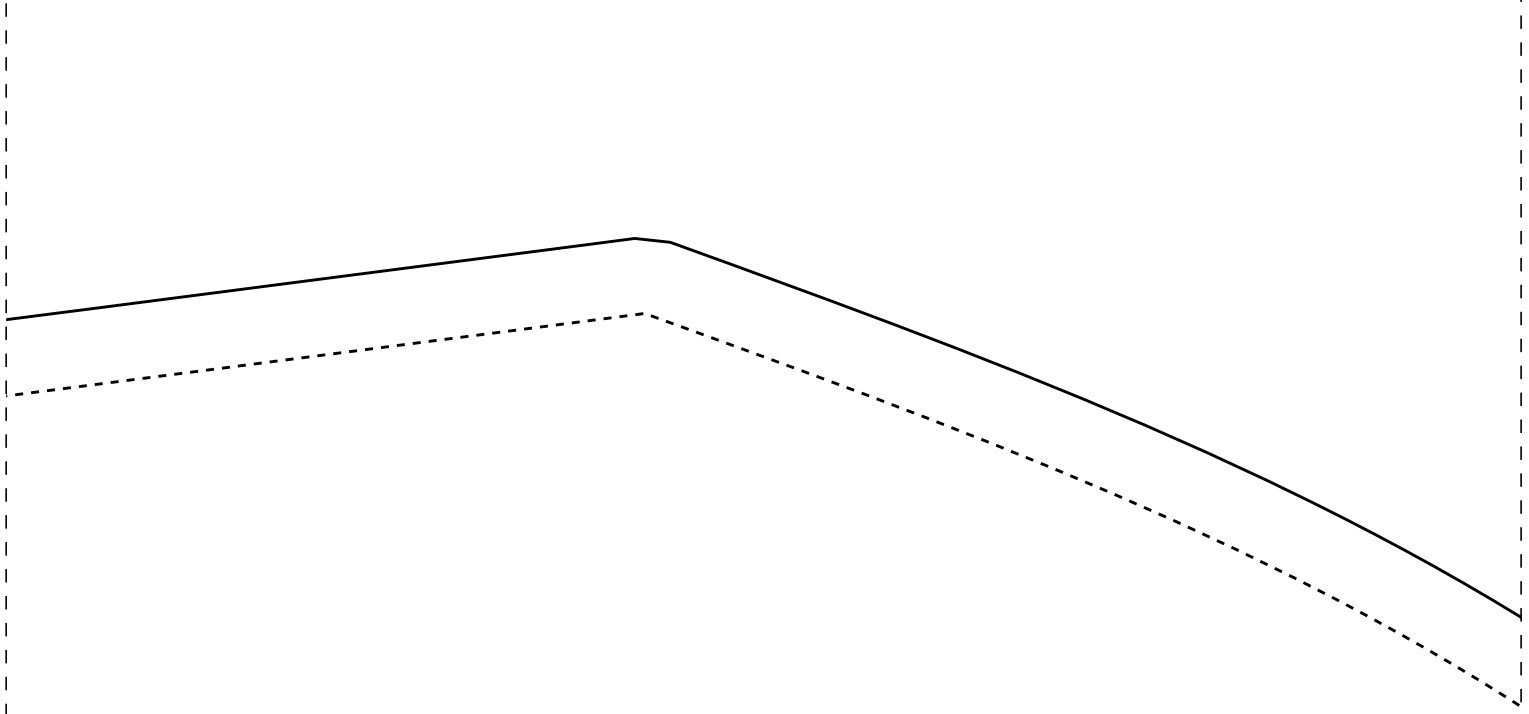





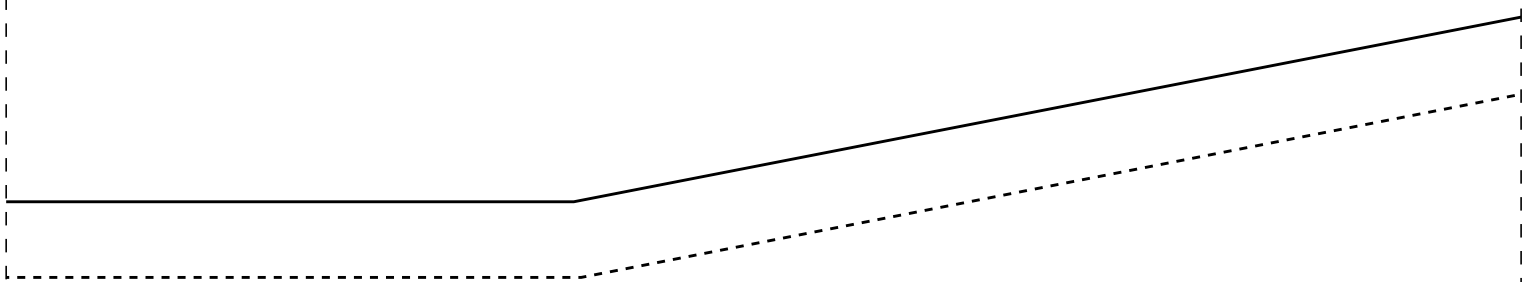

2-12

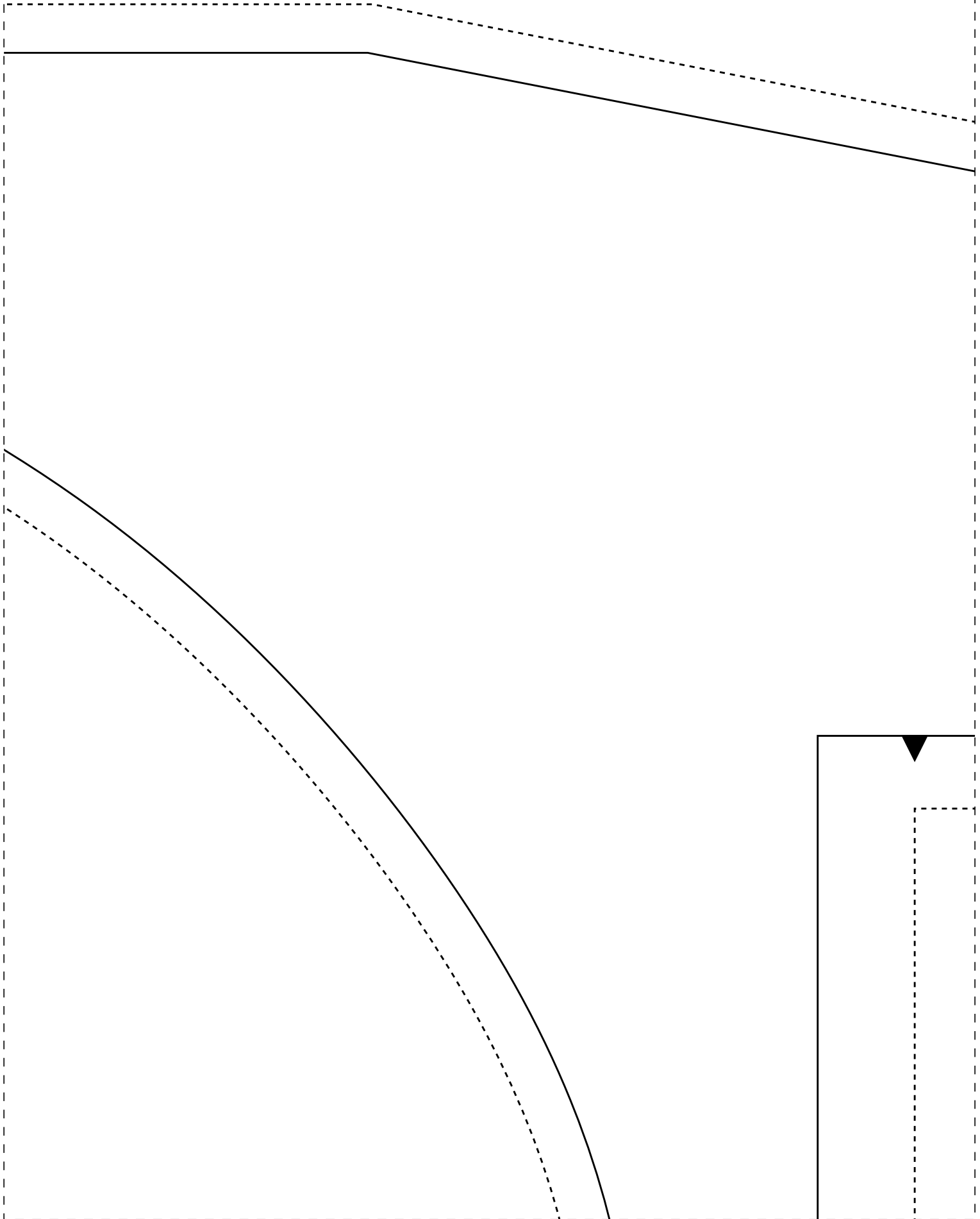

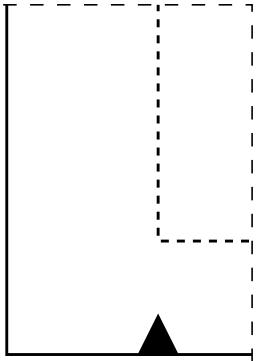
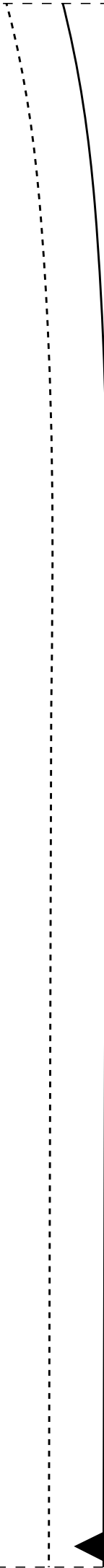





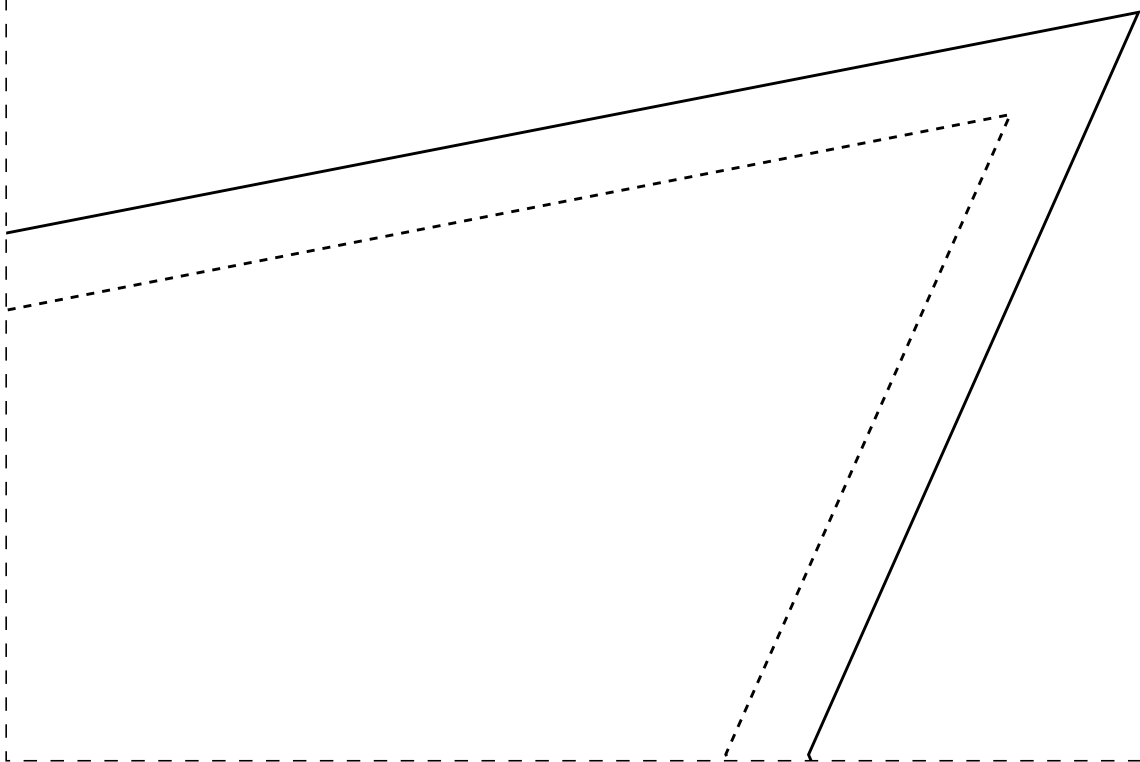

2-13

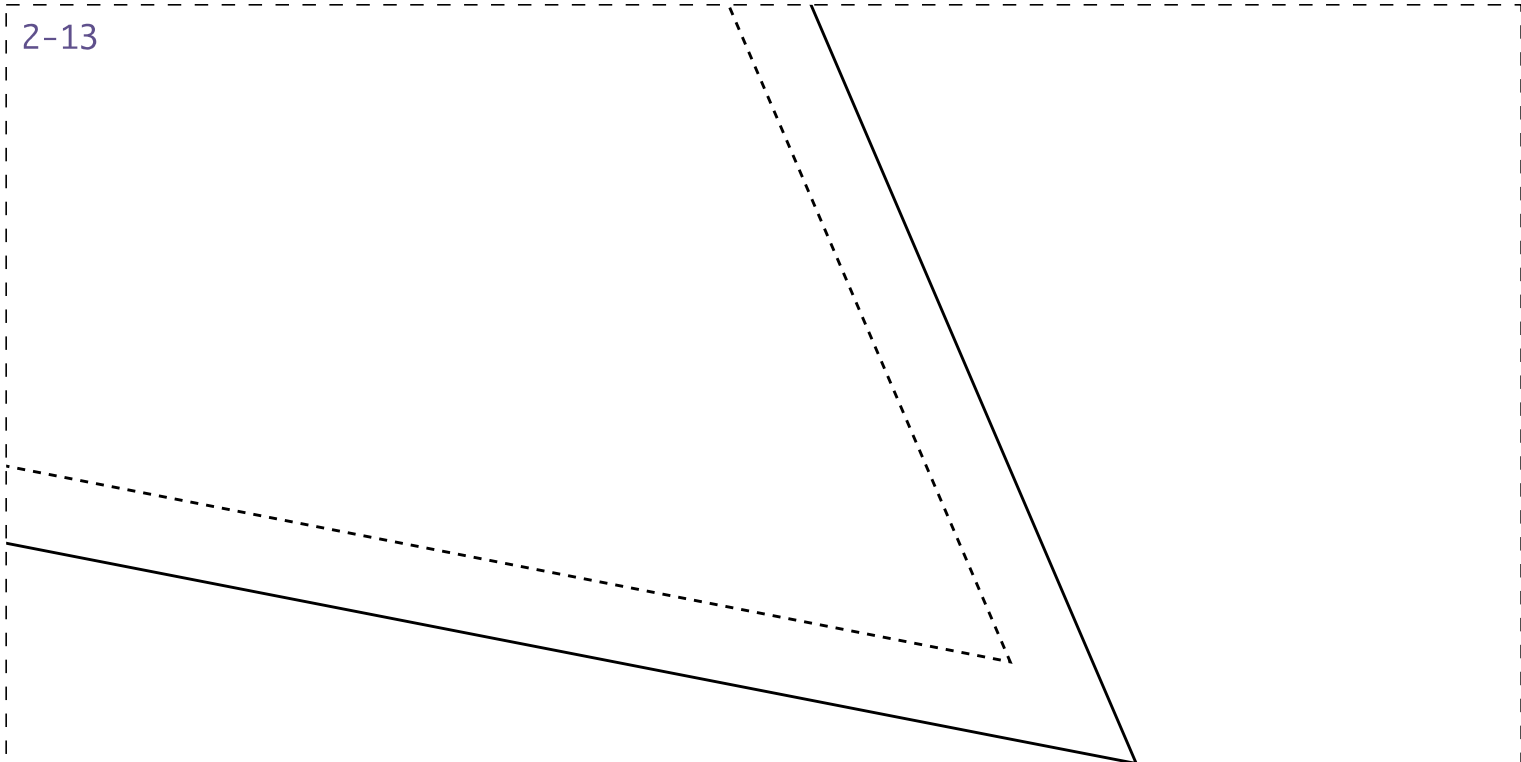

**BOLSO 2X-52**



IDD33

3-13

GABARITO/BS-52



IDD33

