

1-1

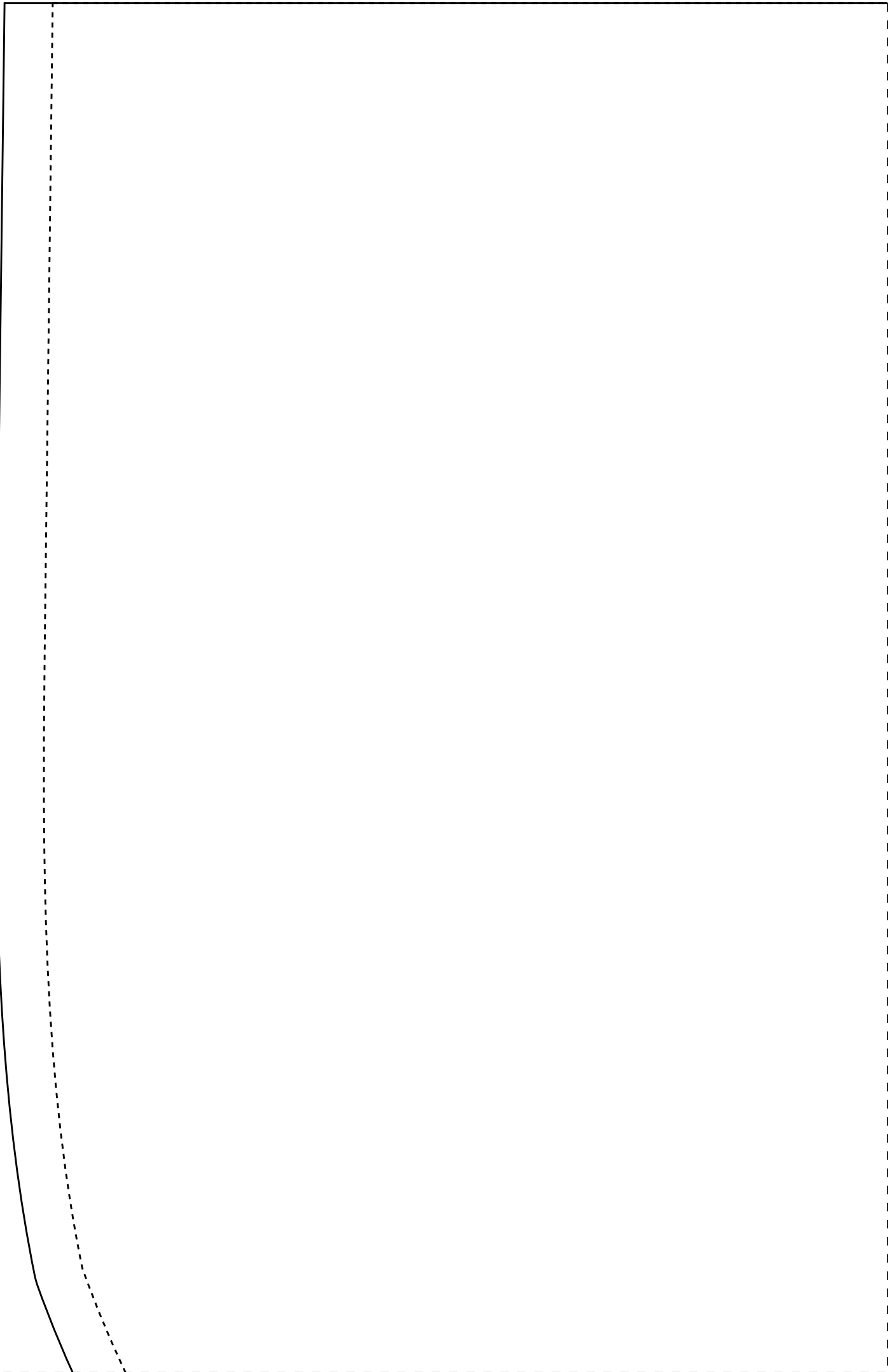

2-1

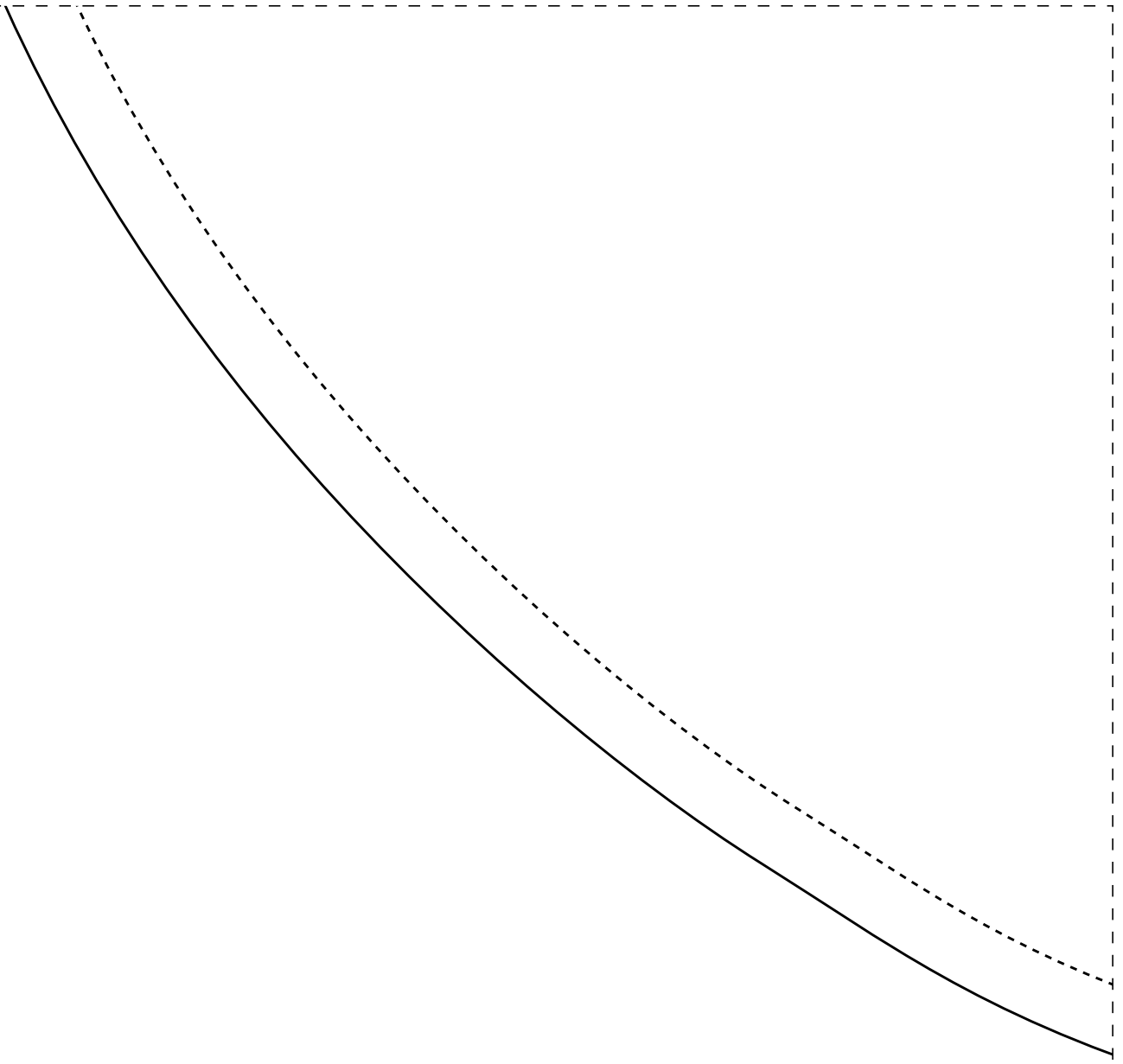

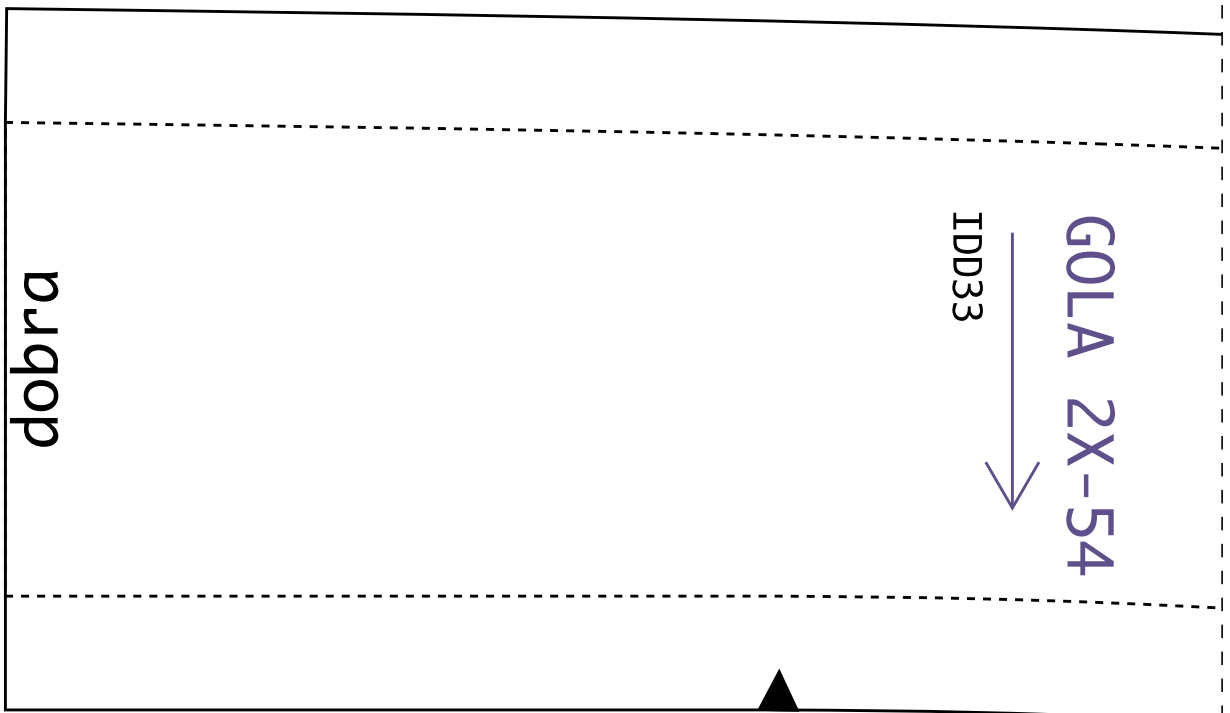
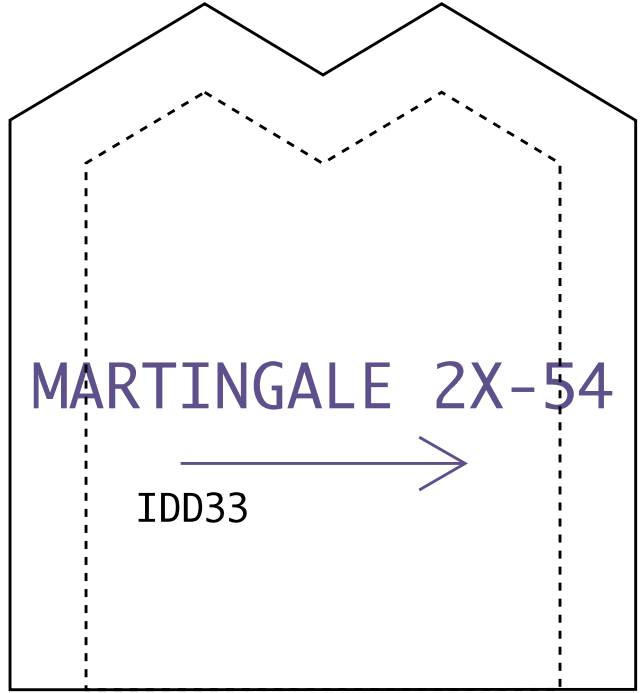



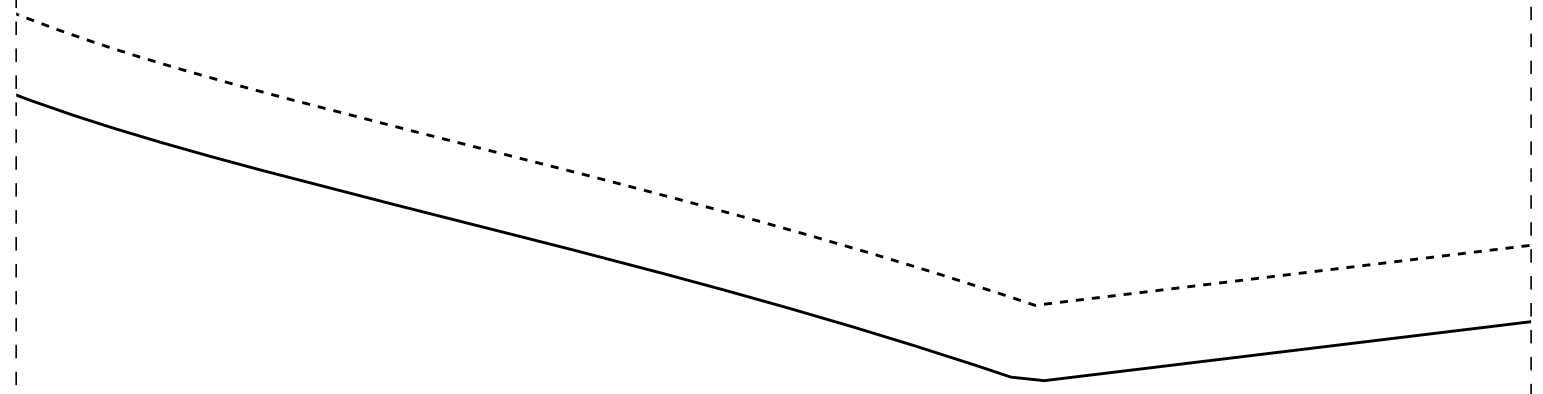

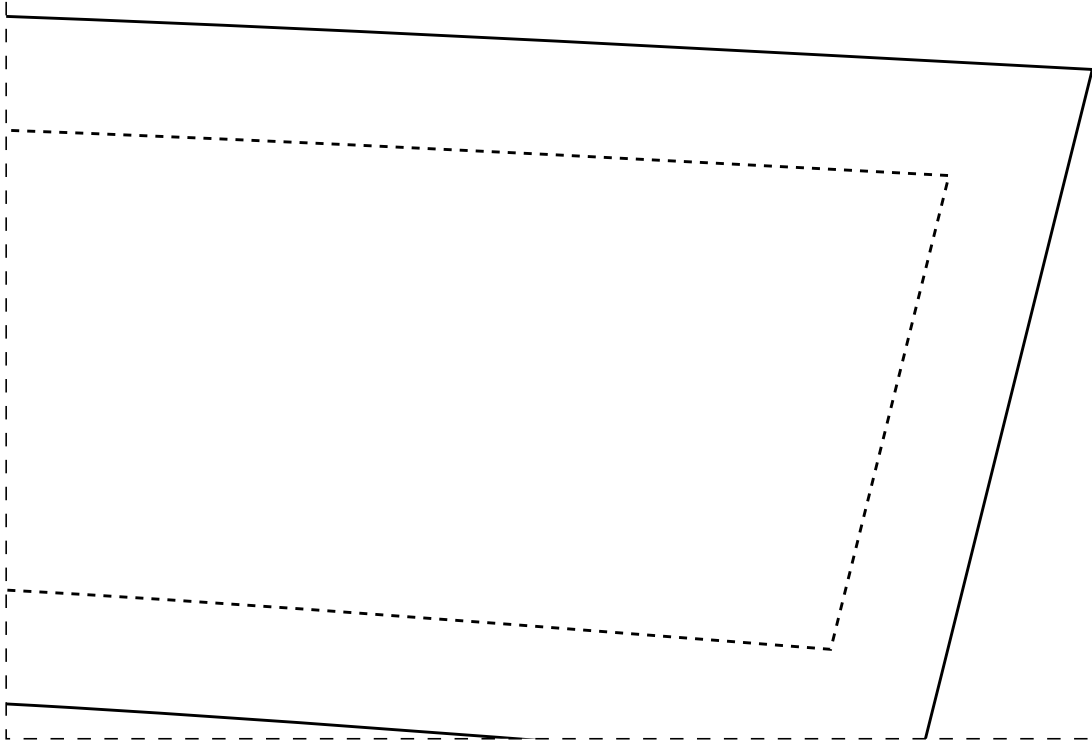

DD33

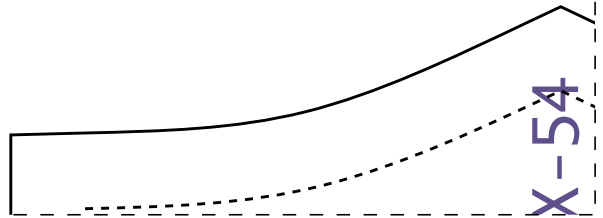
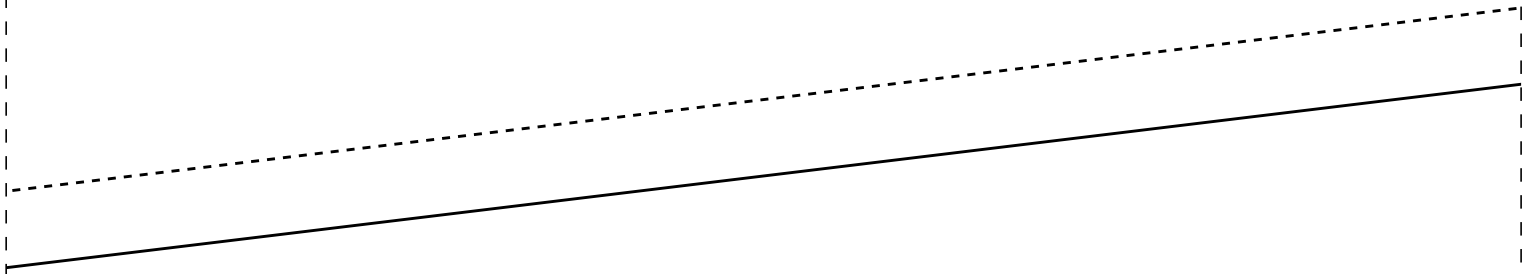

X-54

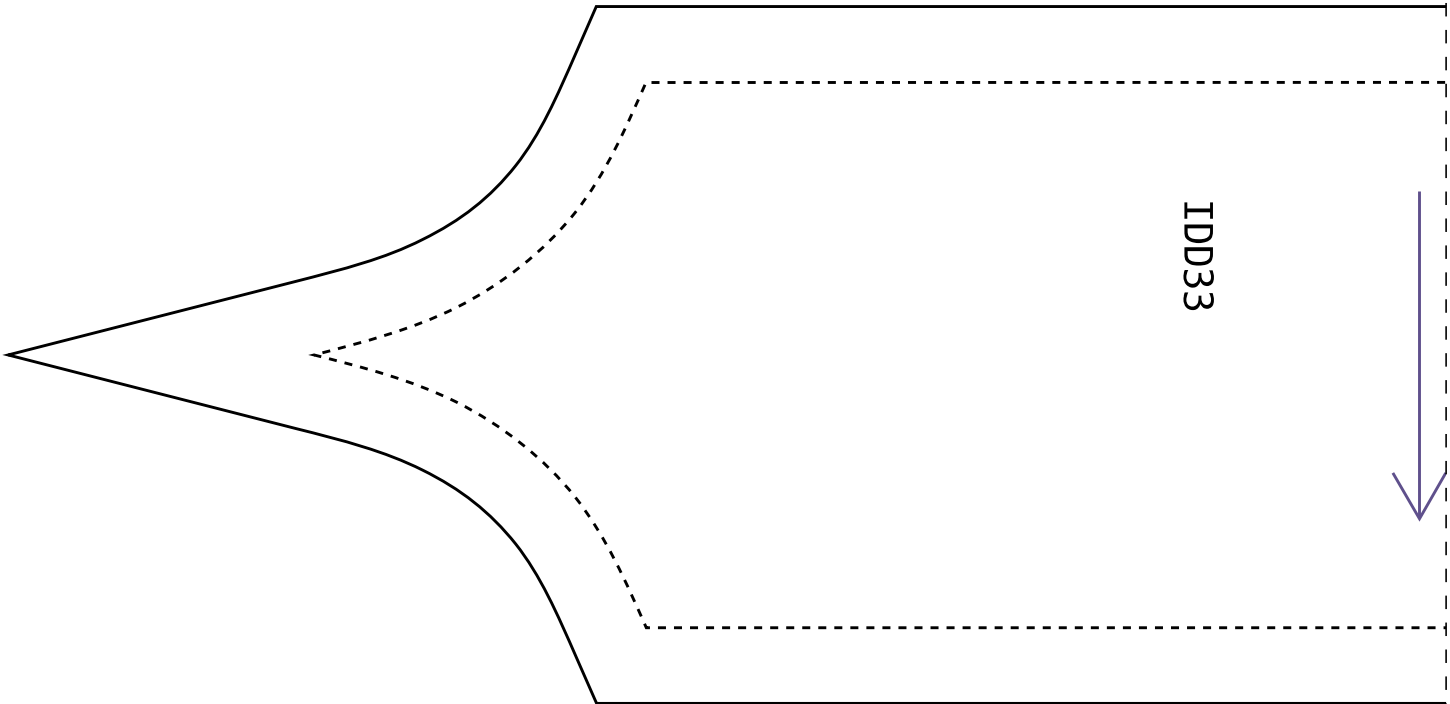
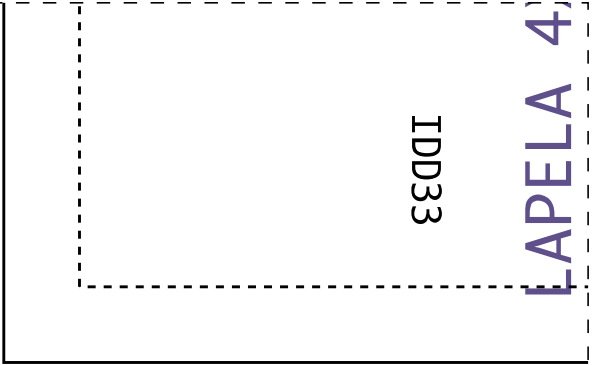

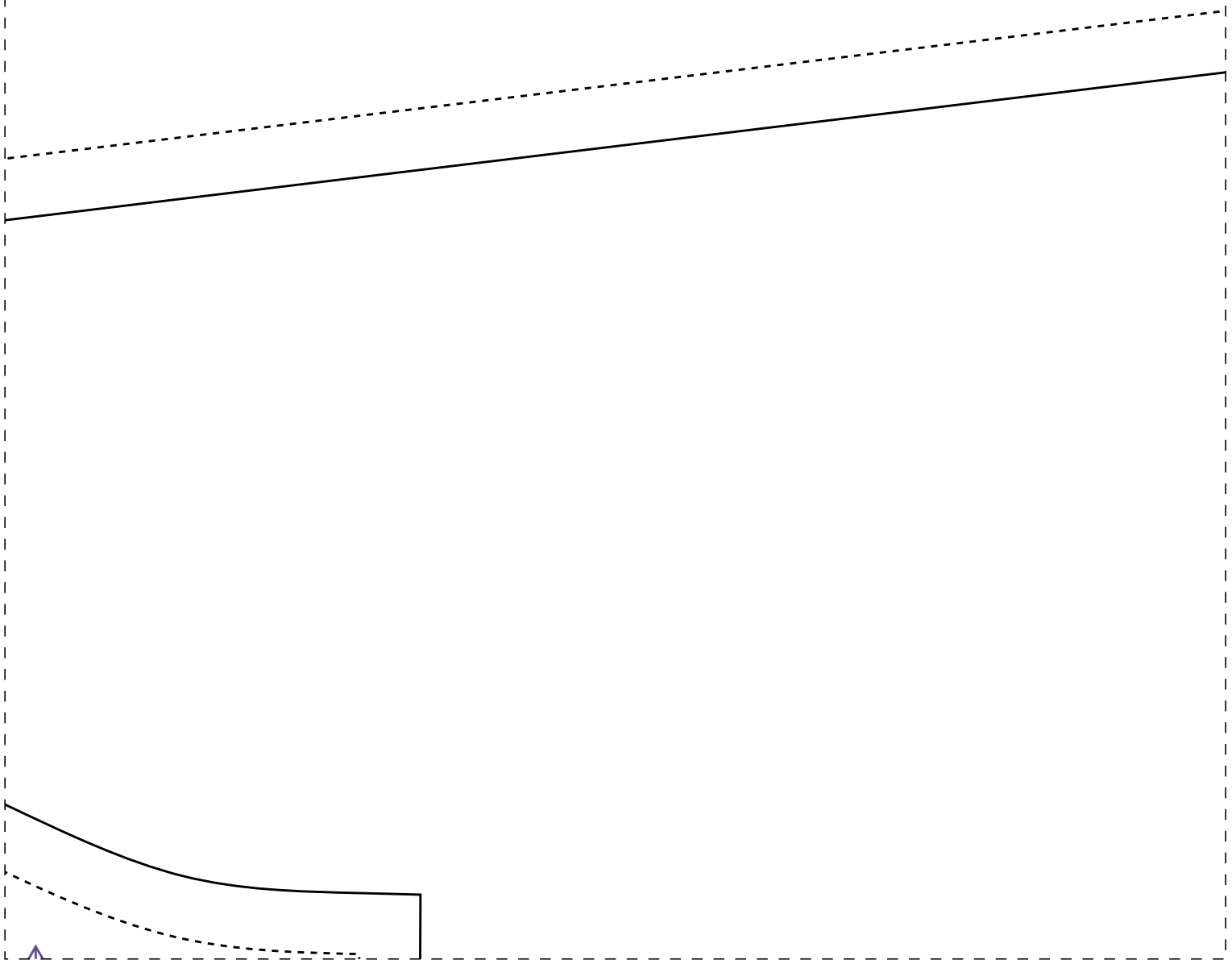

3-4

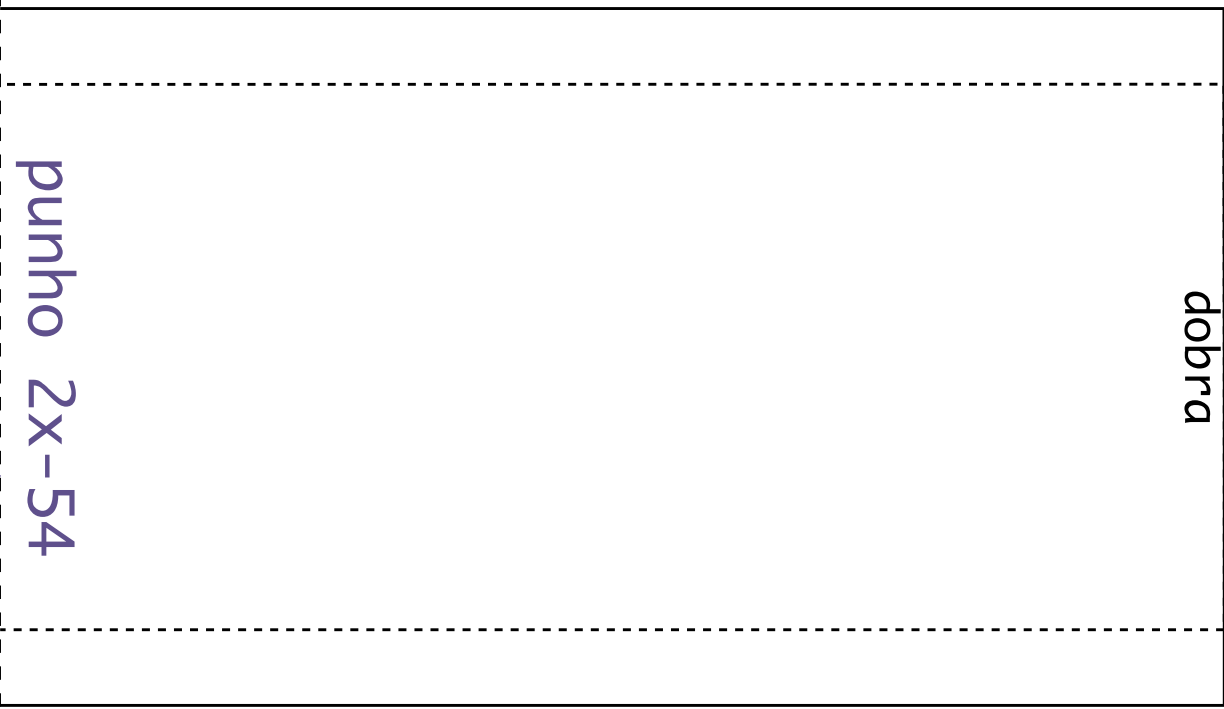

dobra

punho 2x-54

1-5

dobra

COSTA

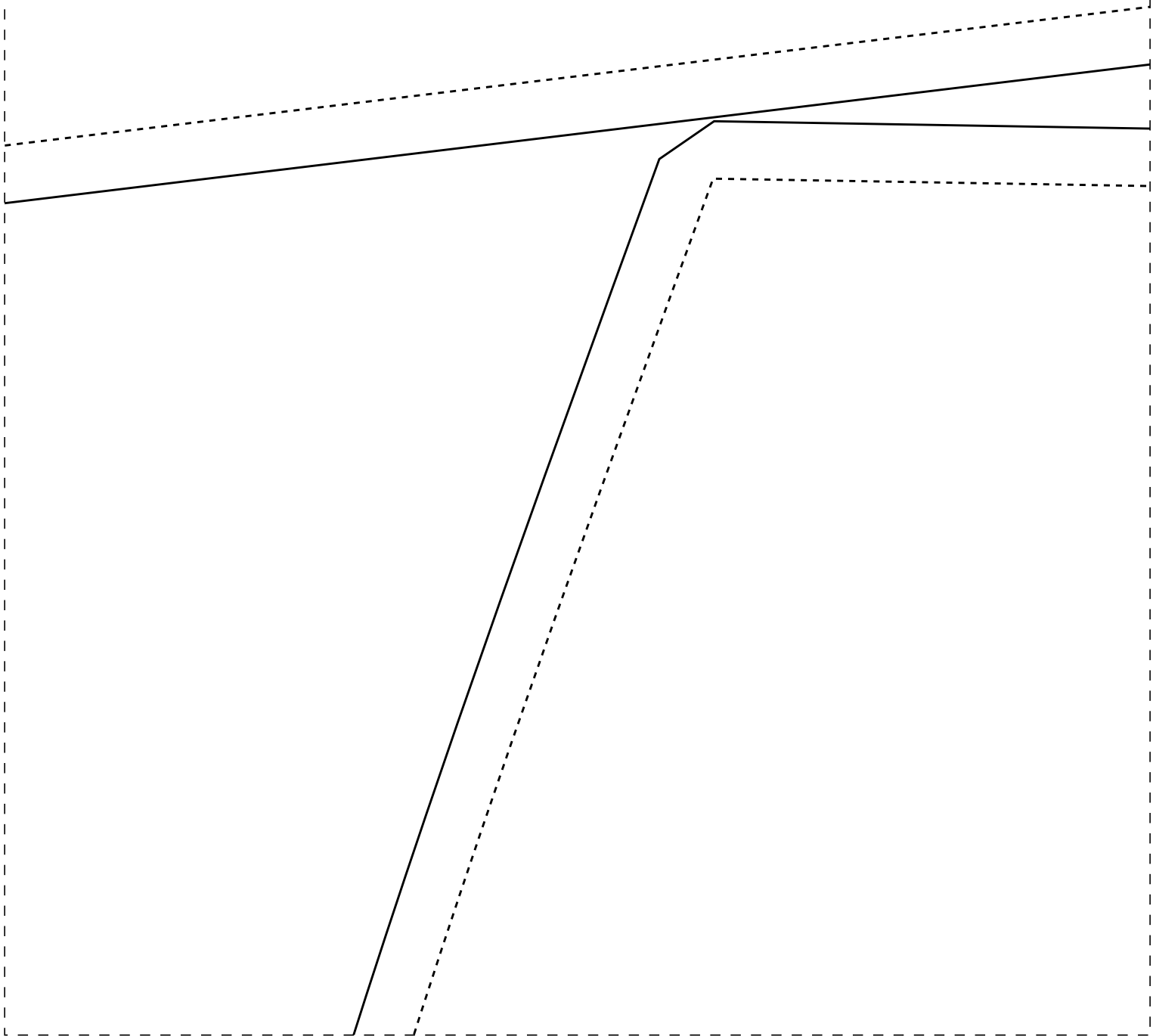

3-5

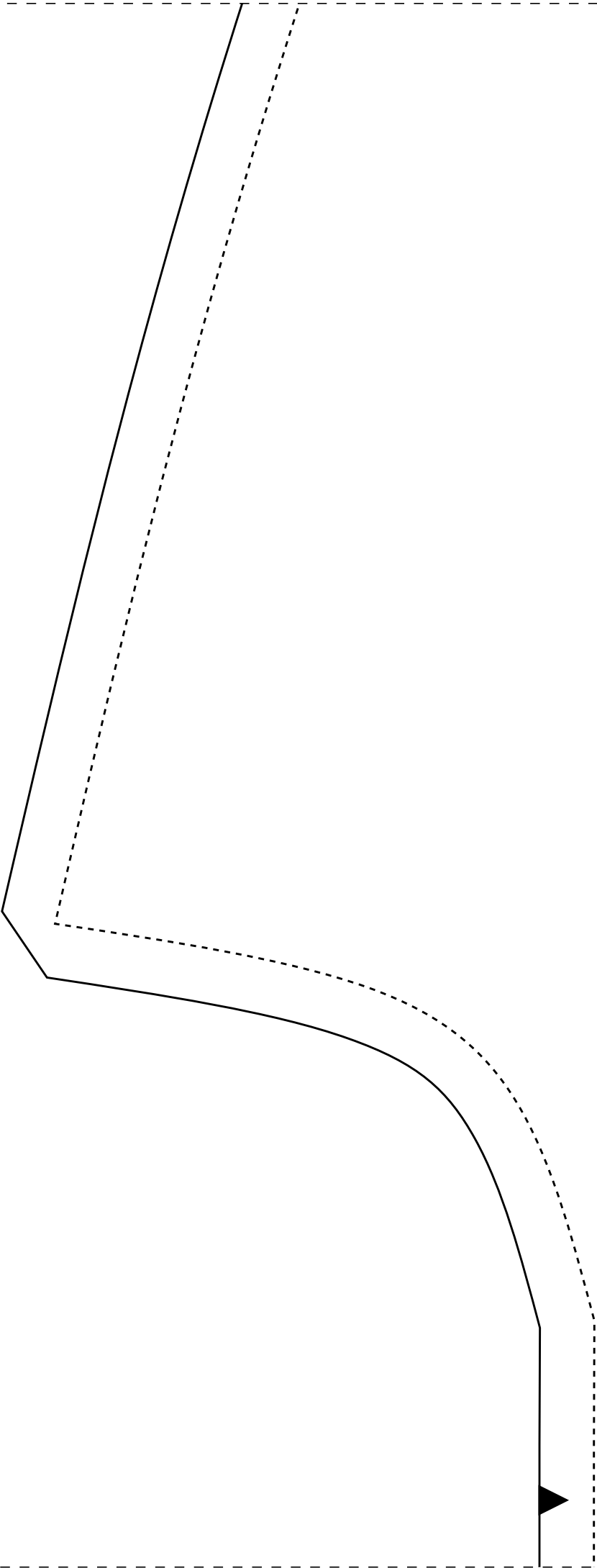

gold

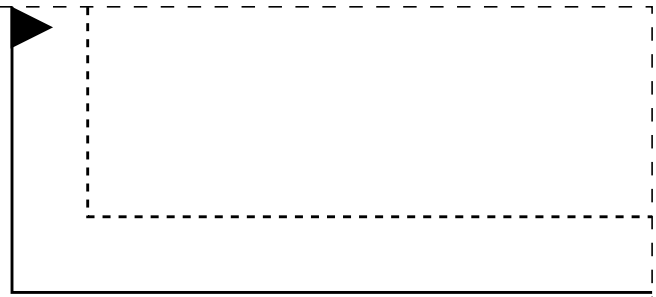

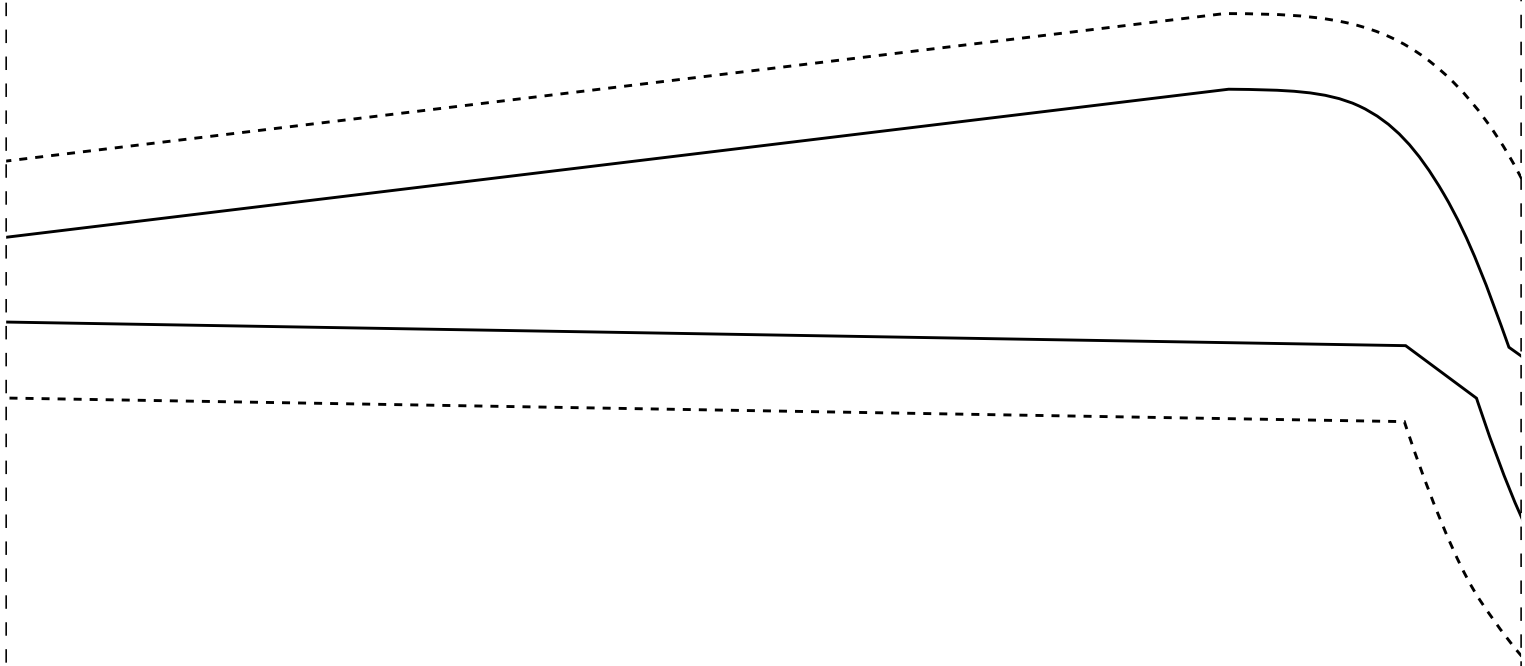

Lapela/bolsa

4-6 peitilho pronto 2,5cm

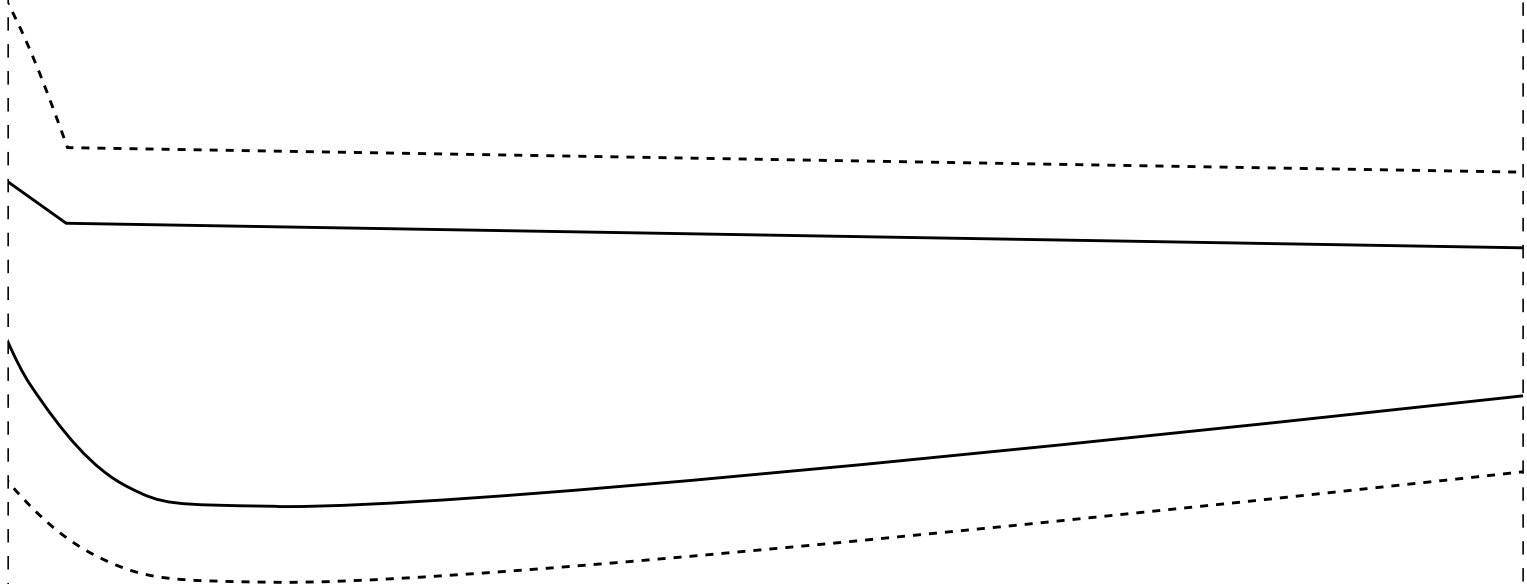

IDD33

1-8

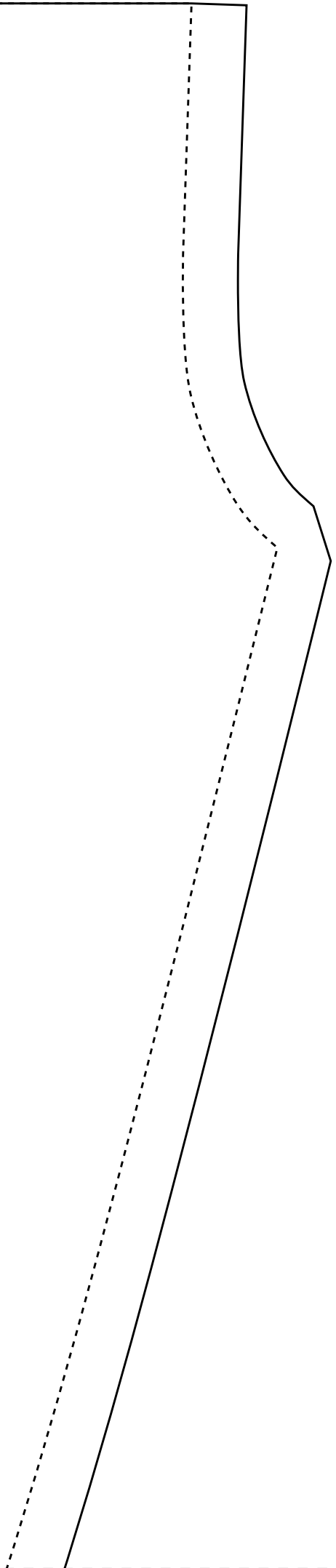

2-8

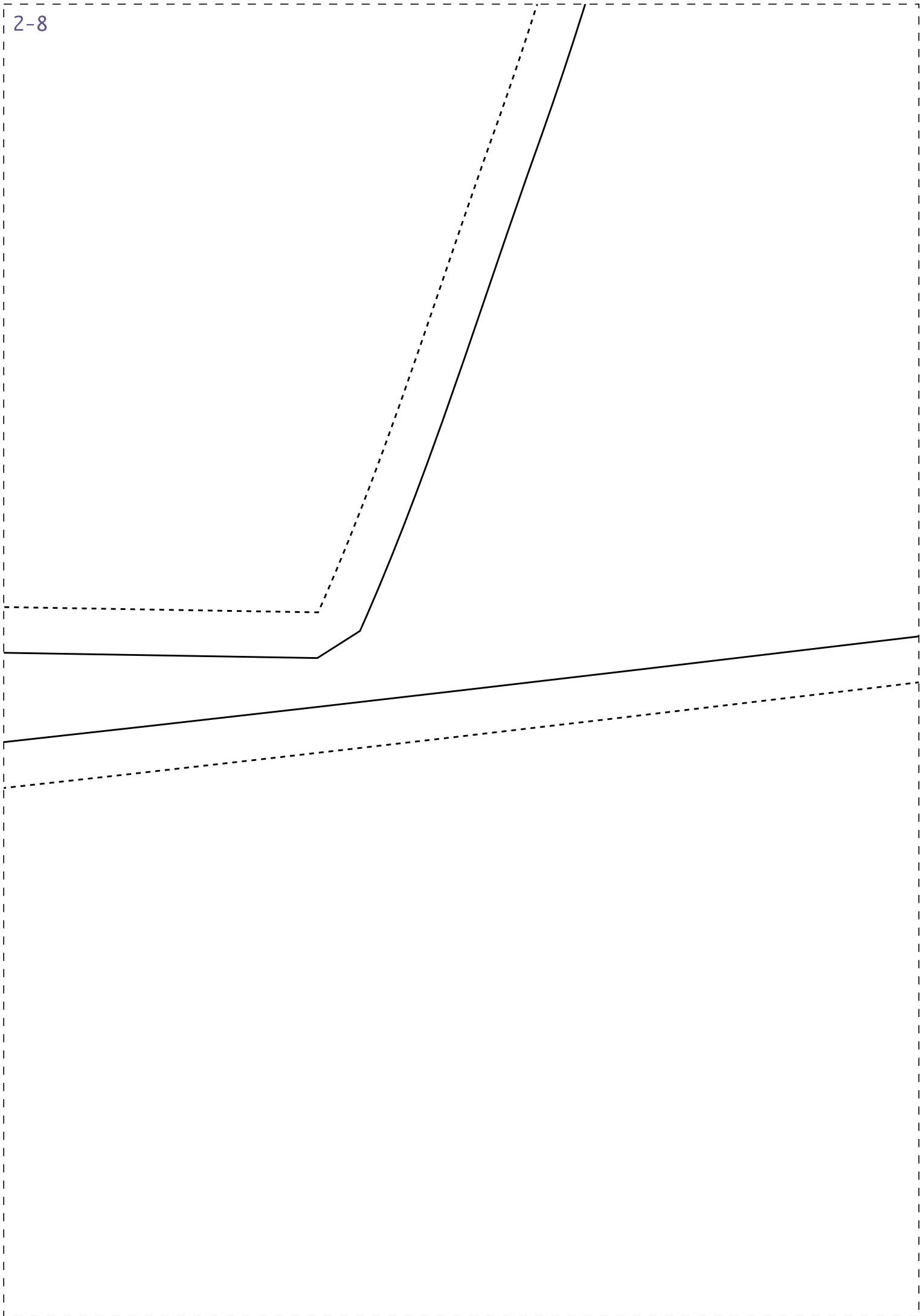

FRENTE

FICHA TÉCNICA:

- Tecido plano 1,4m de largura
- Viscolinho, linho, viscose ou s
- Peça com martingale, bolso e la
- Manga com punho
- Peitilho dobrado na peça pronto com 2,5cm
- Fechamento com caseado e botões
- Bainha de lenço ou viés
- 3,3m para todos os tamanhos



Teste de impressão: ao imprimir seu molde, meça o quadrado que deverá ter a mesma medida informada (4cm), assim você se certificará que ele foi impresso no tamanho correto.

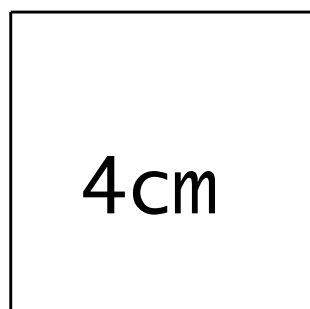

dobra

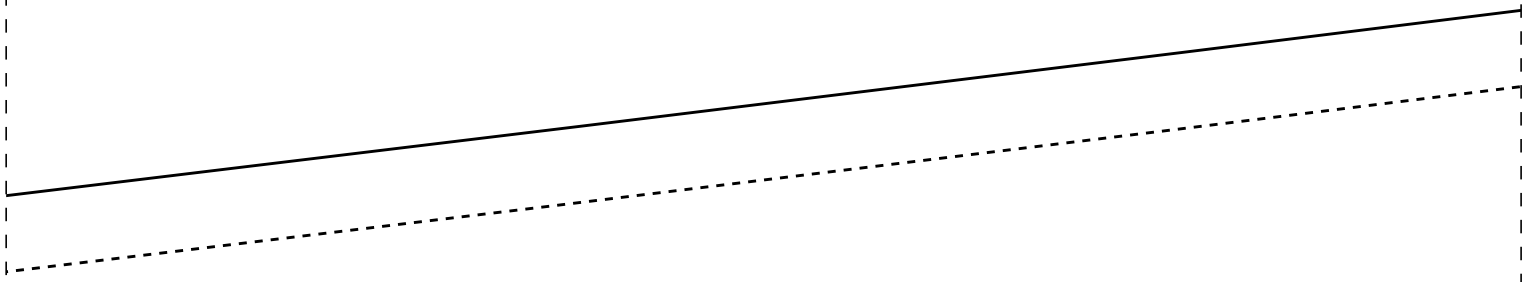

3-9

2X-54

similares
pela



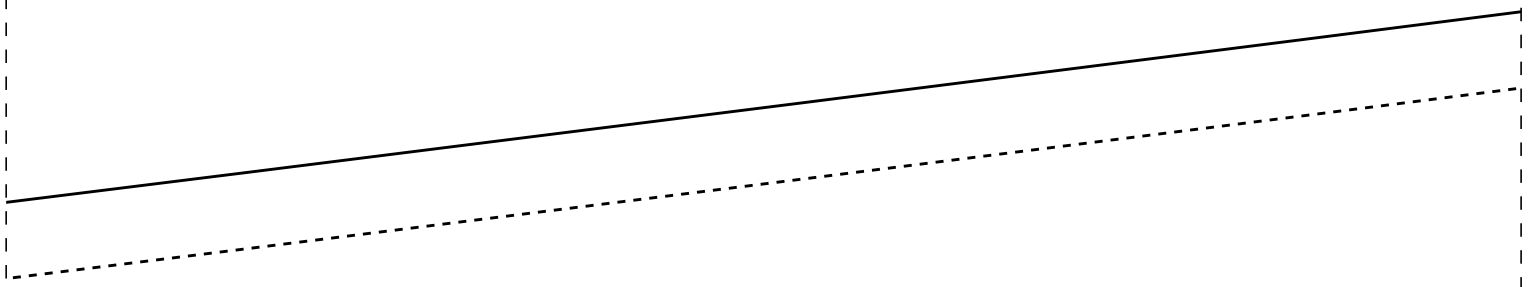





IDD33
CINTO 1X-54



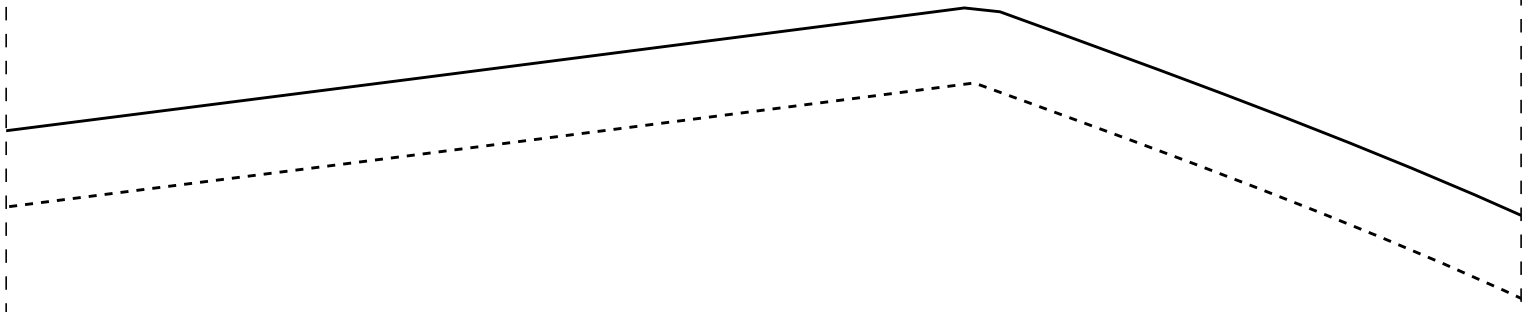





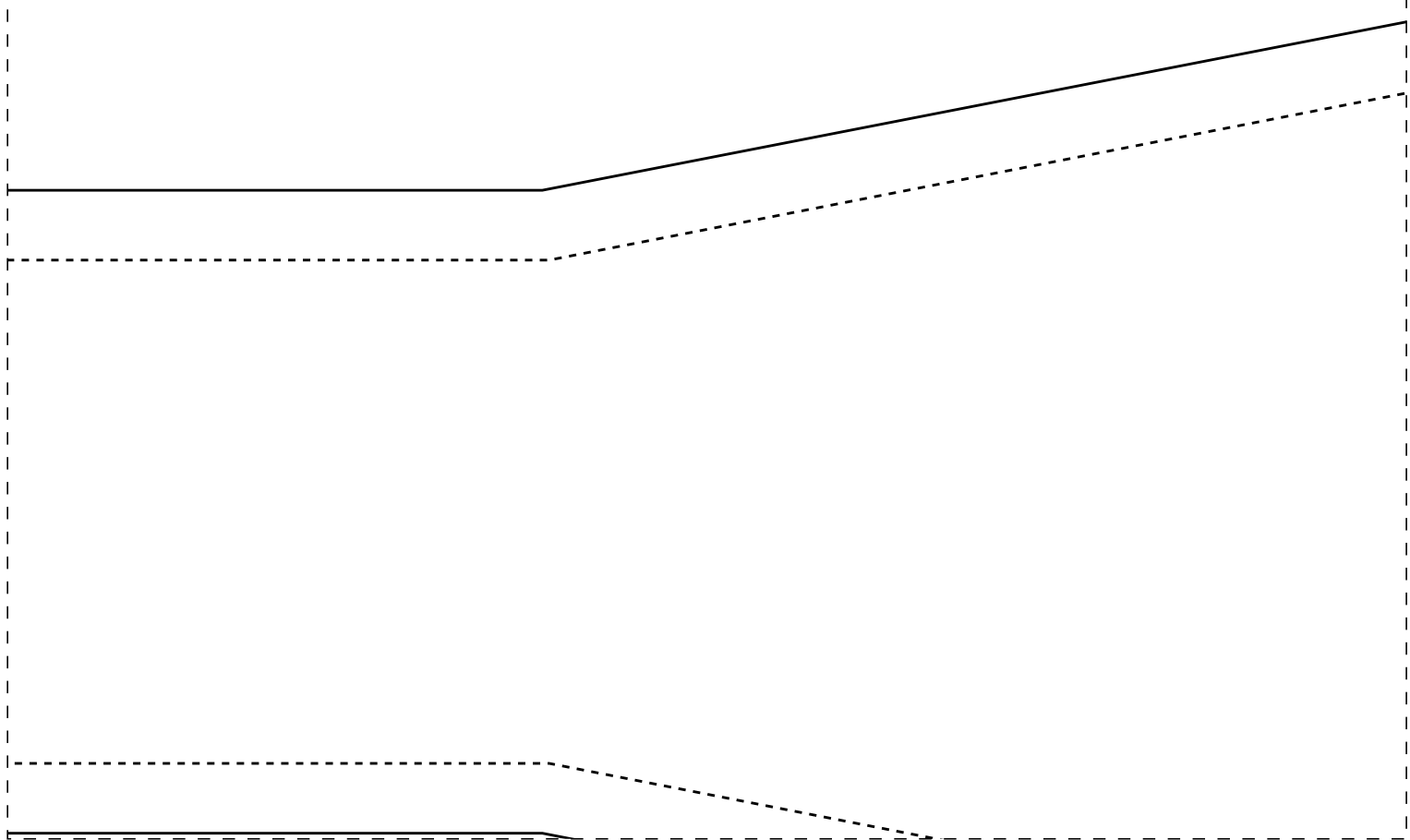

2-12

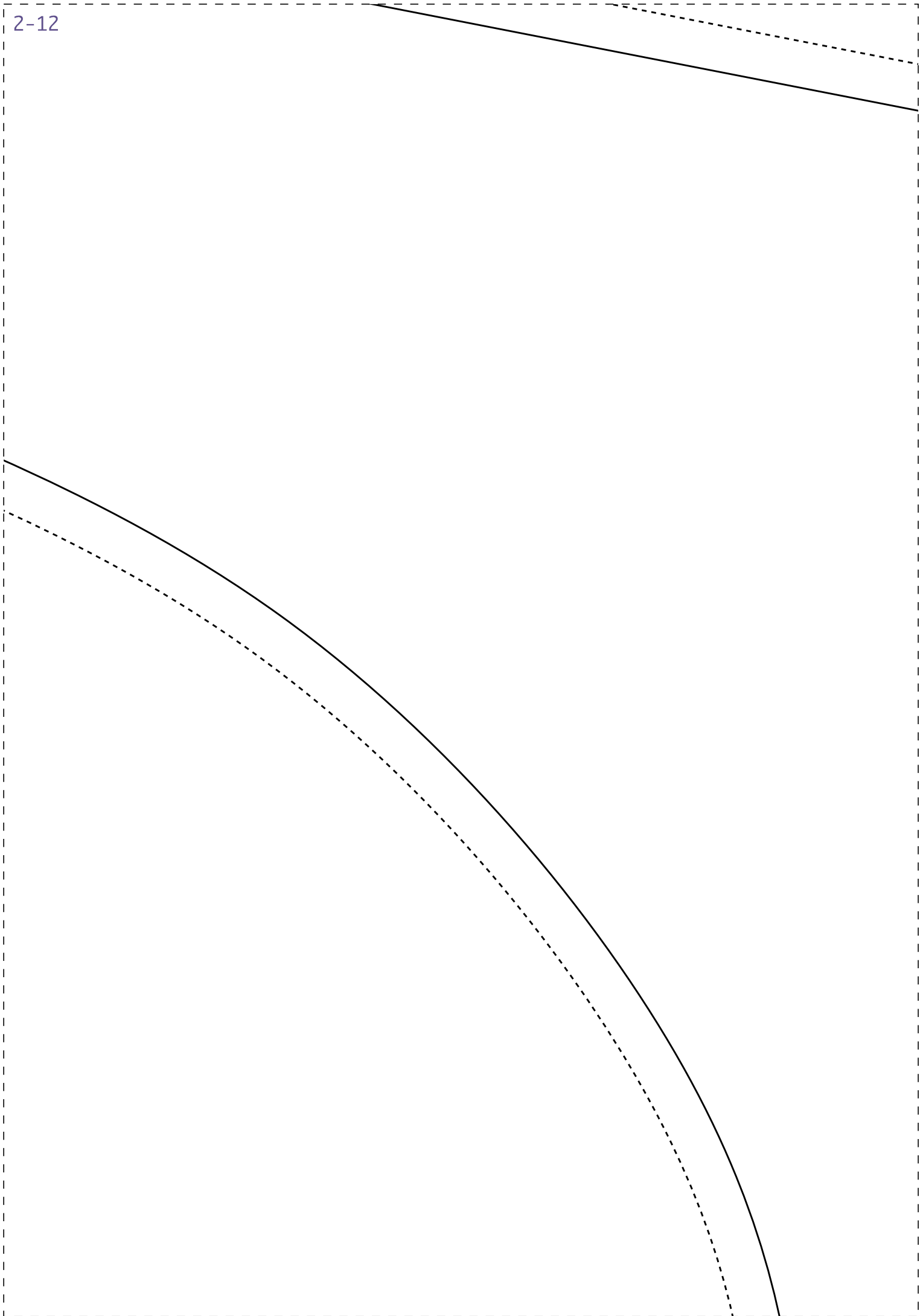

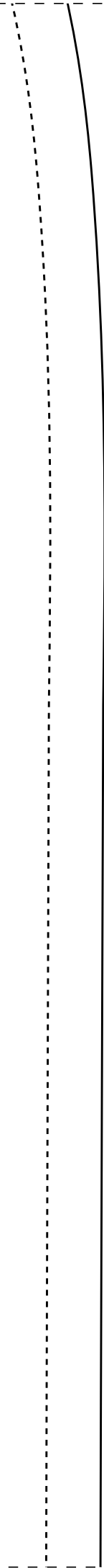



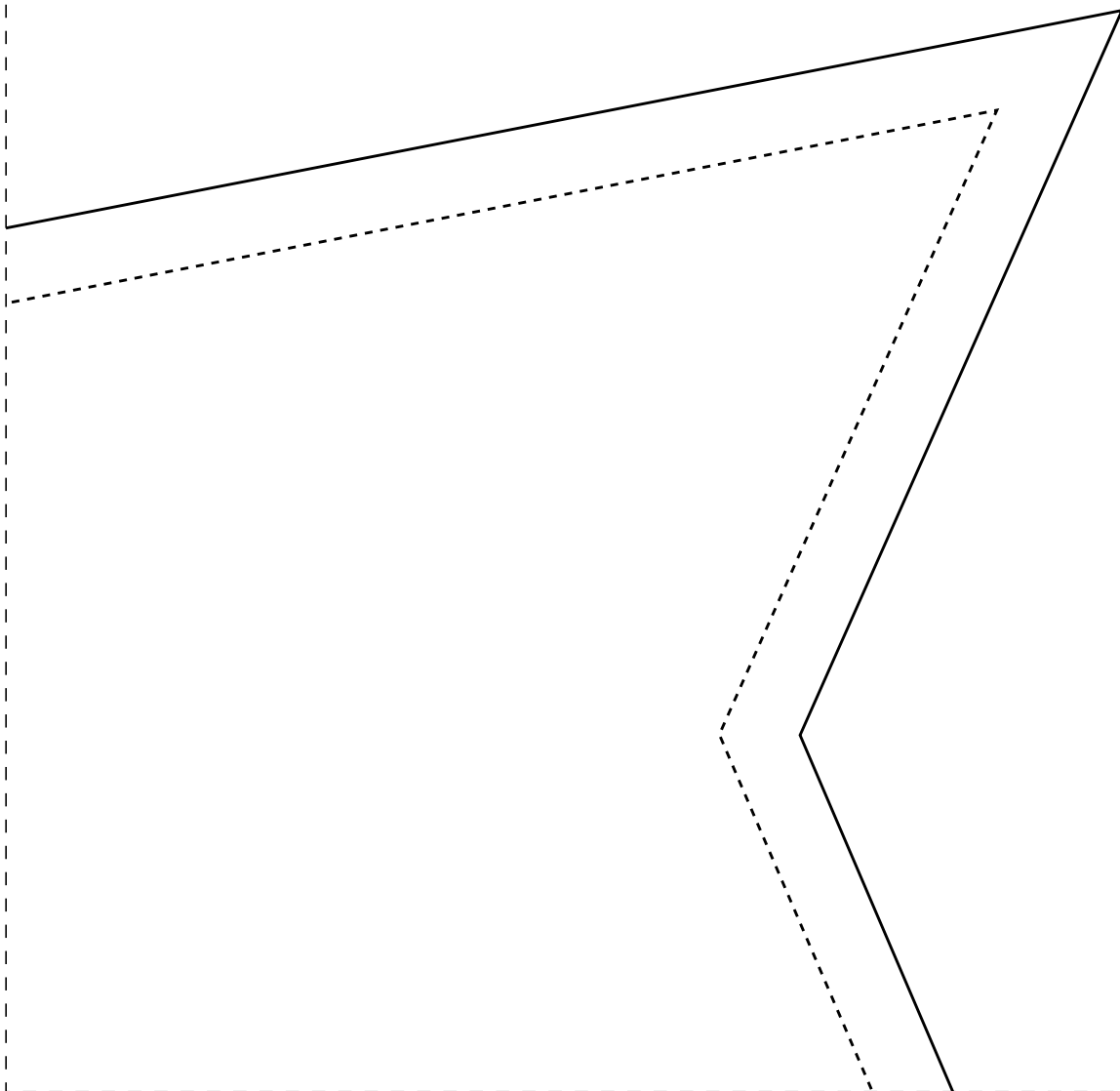

2-13

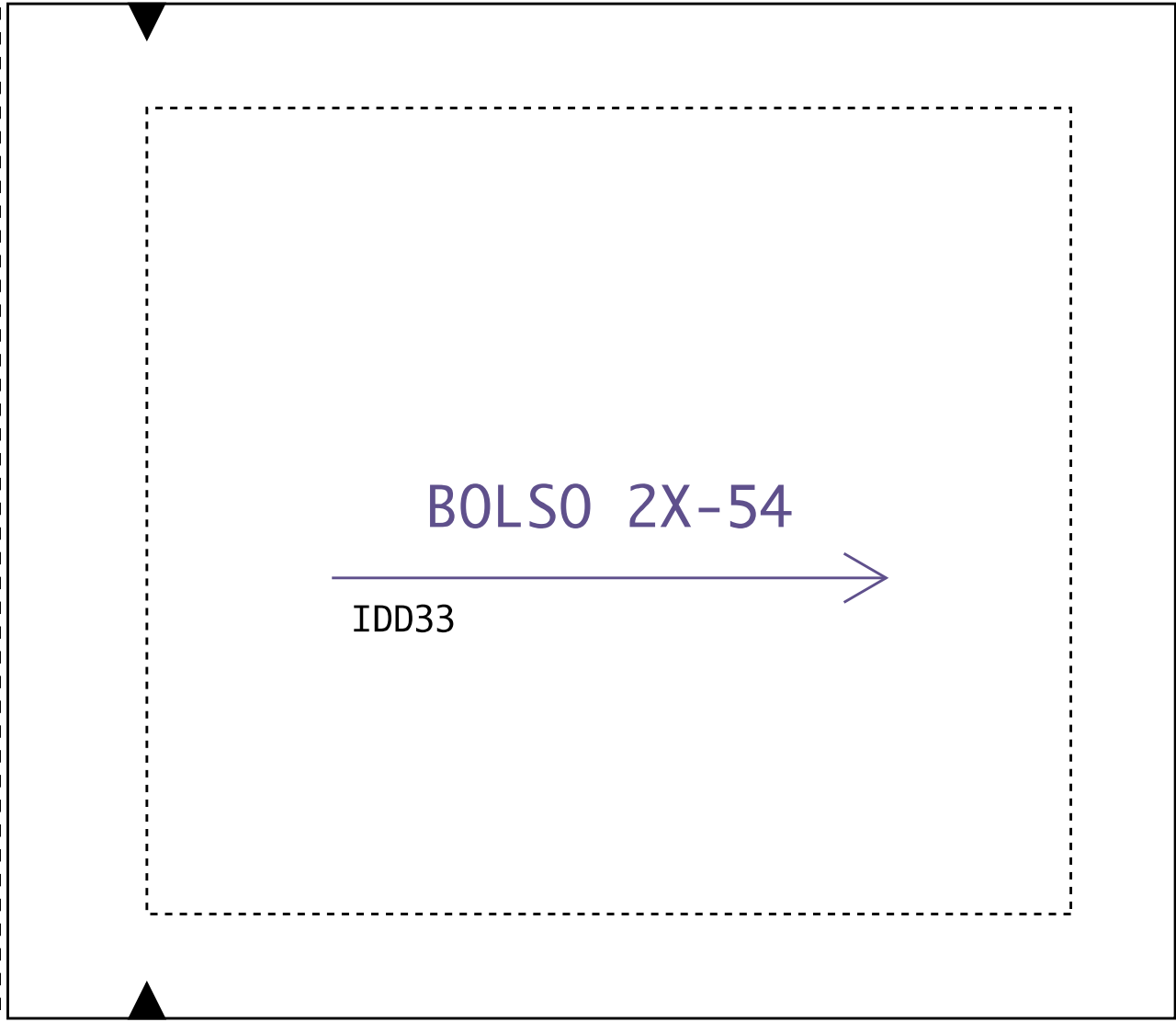
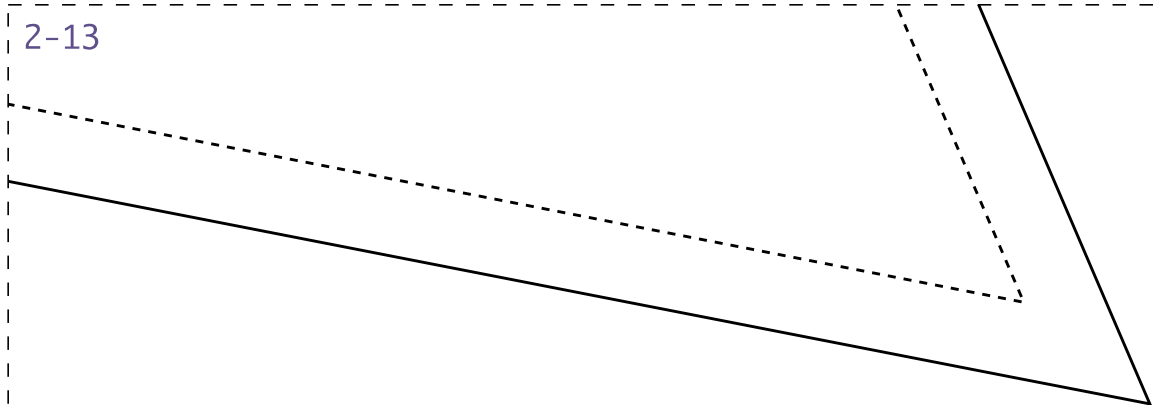

GABARITO/BS-54



IDD33

