

1-1

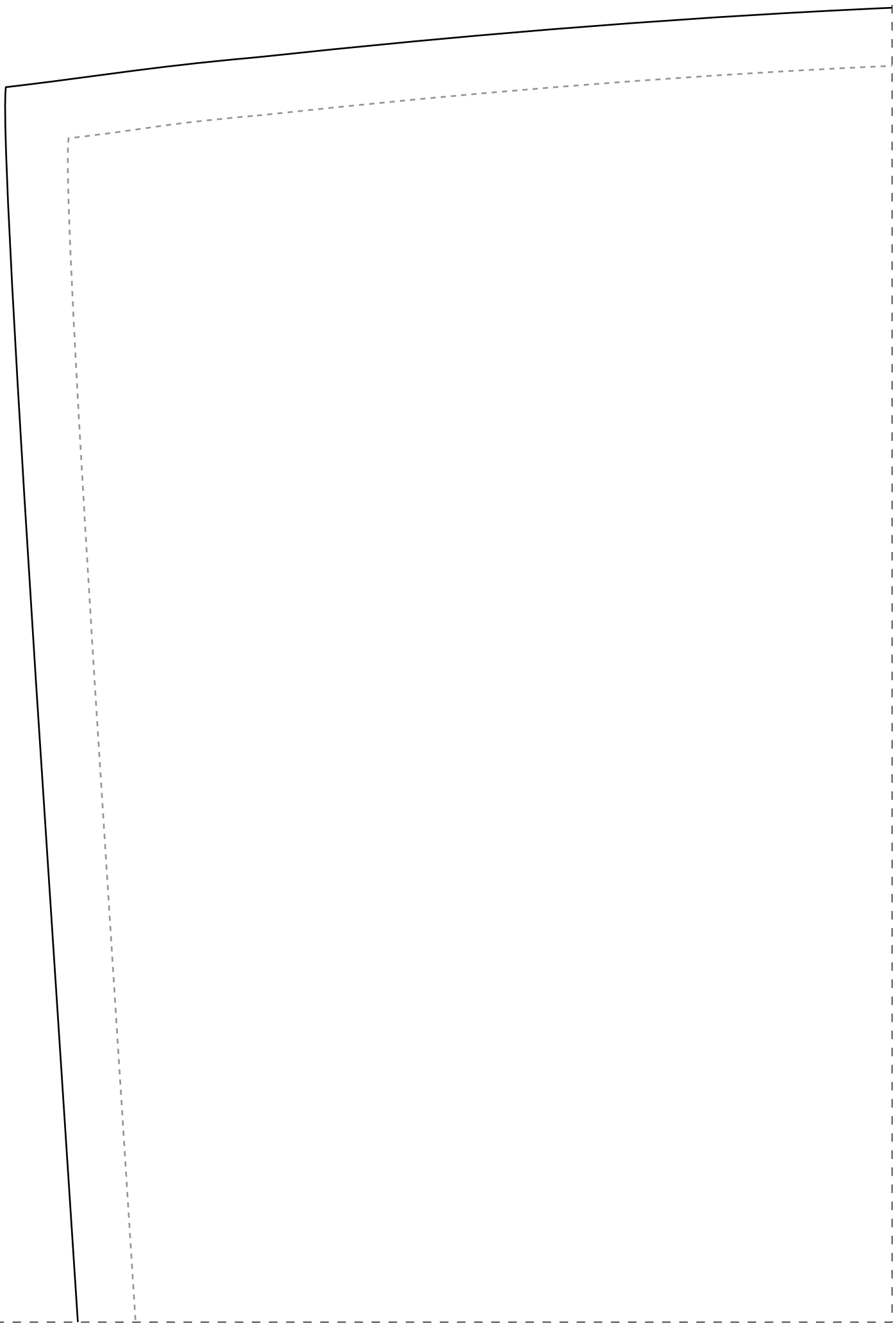

2-1

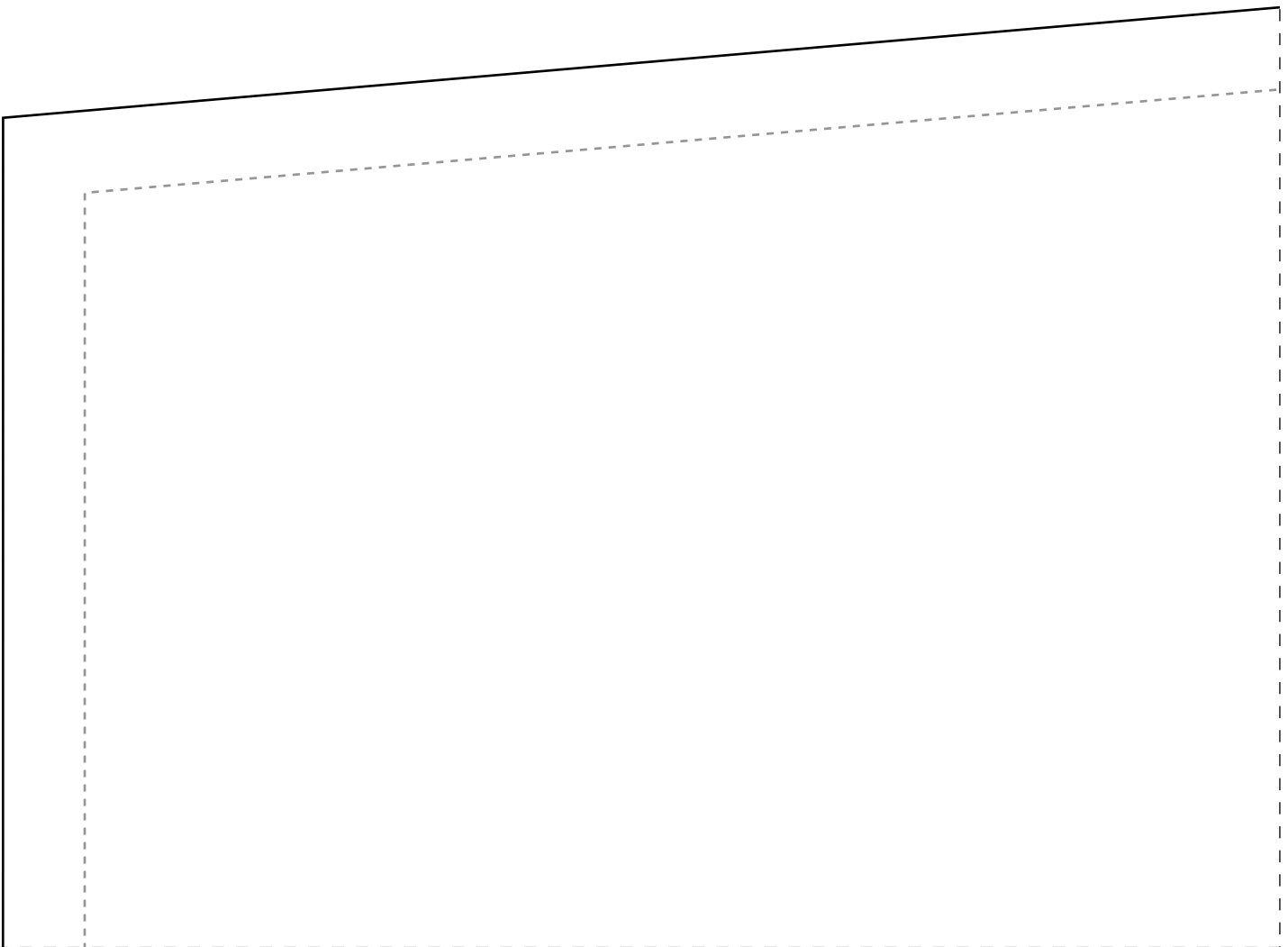

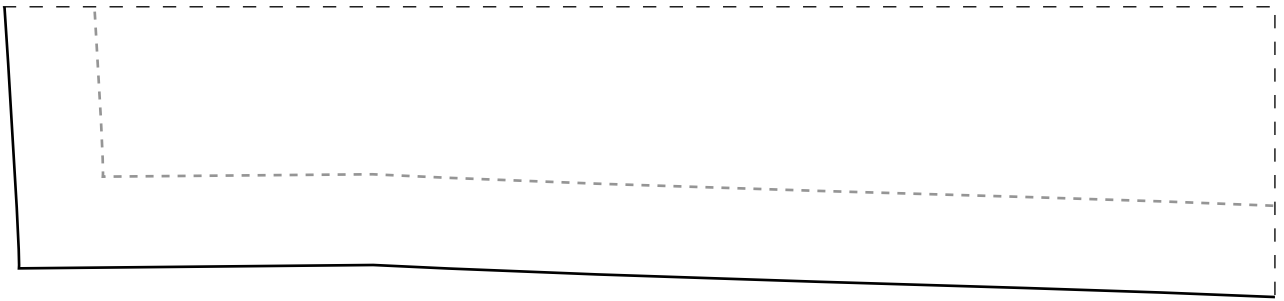

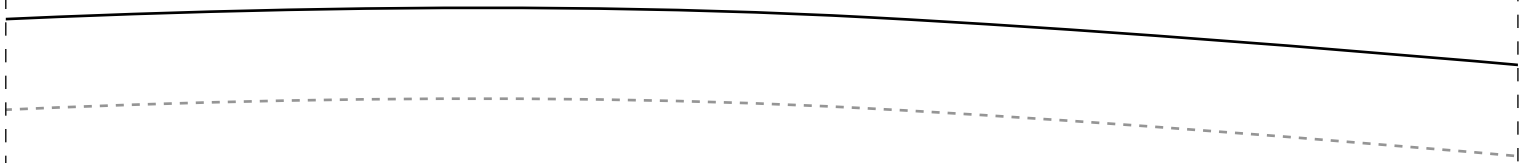

---

2-2

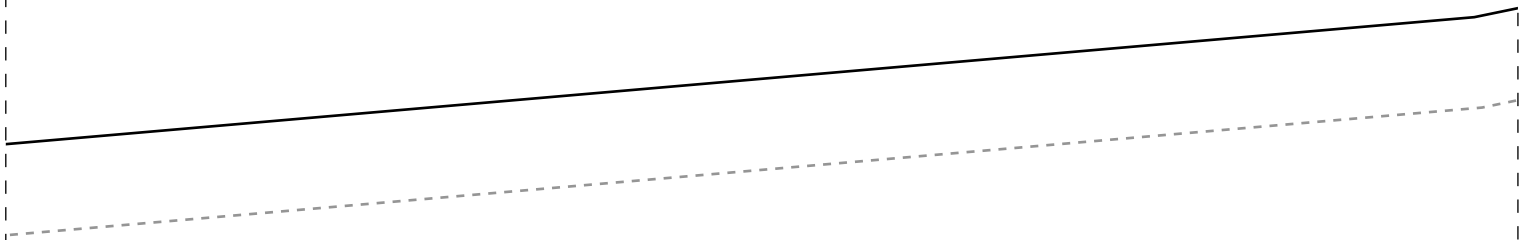
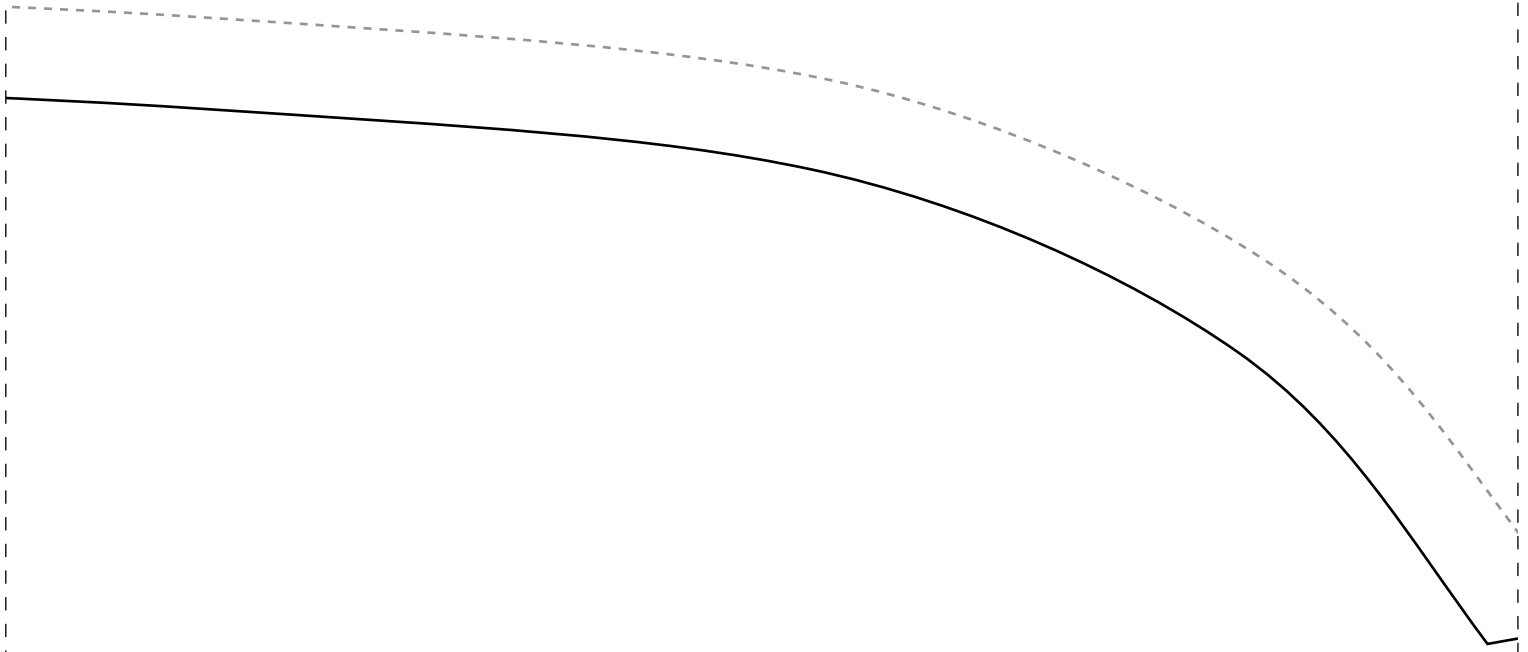

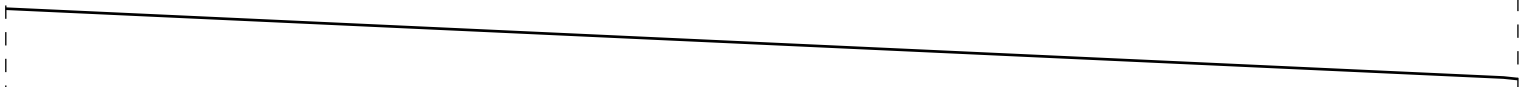

Instituto Diana De  
Expert em confecção  
Pijama Americano

46 - DIANTEI

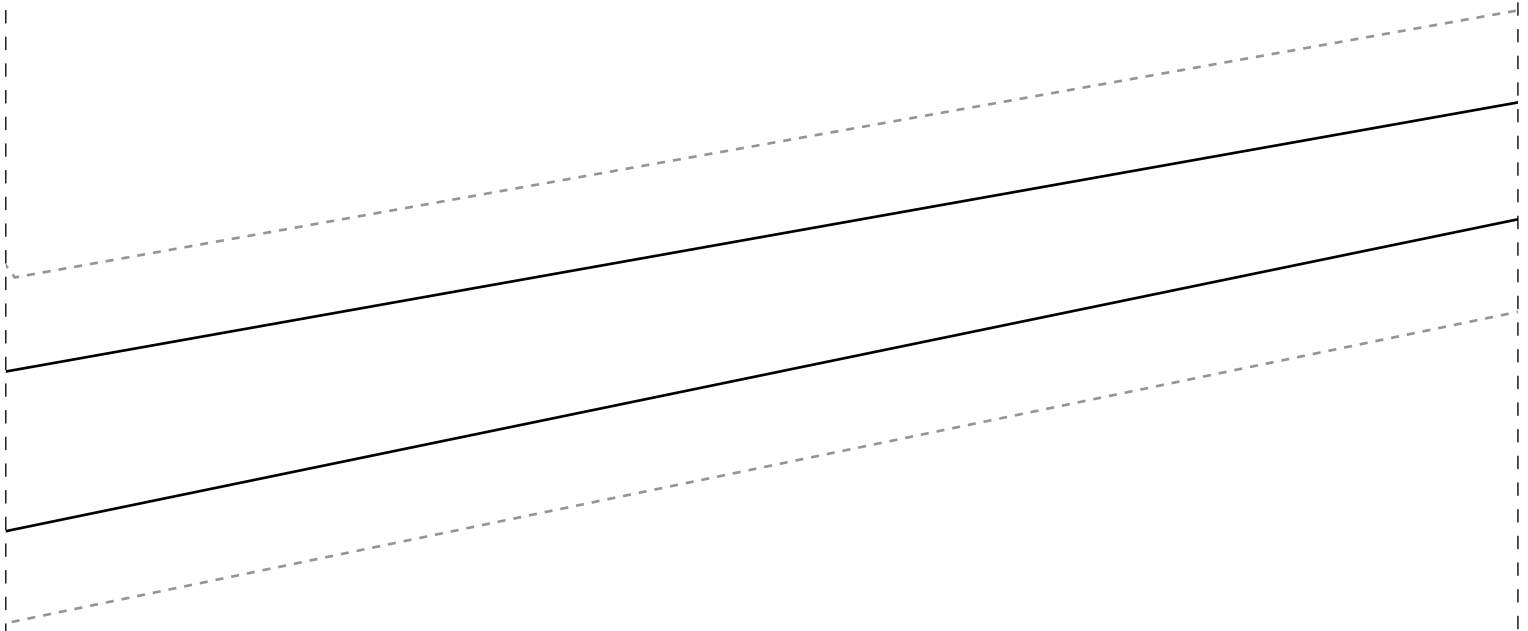



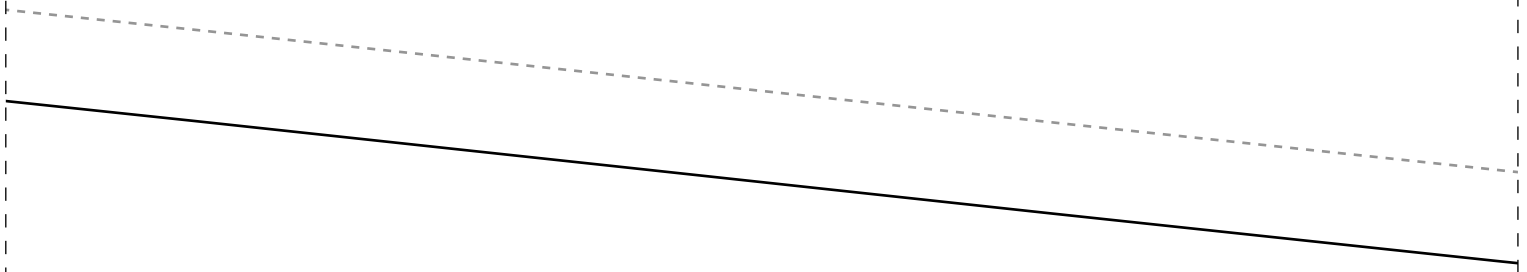

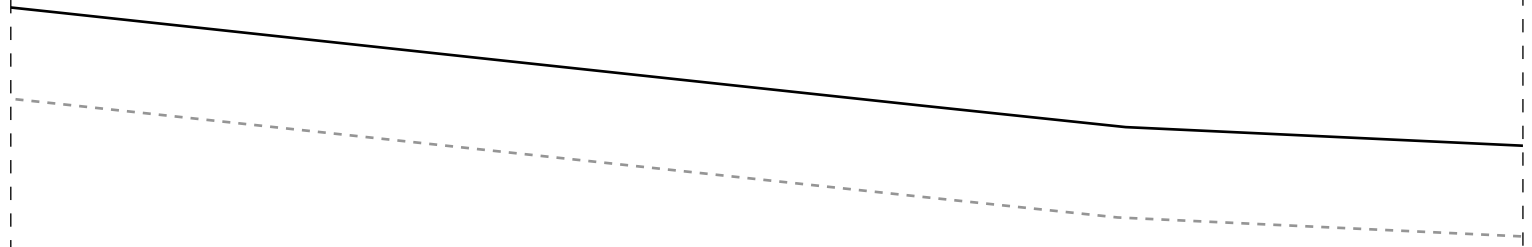

# emarchi ção de Pijamas Feminino

URA 2X

---

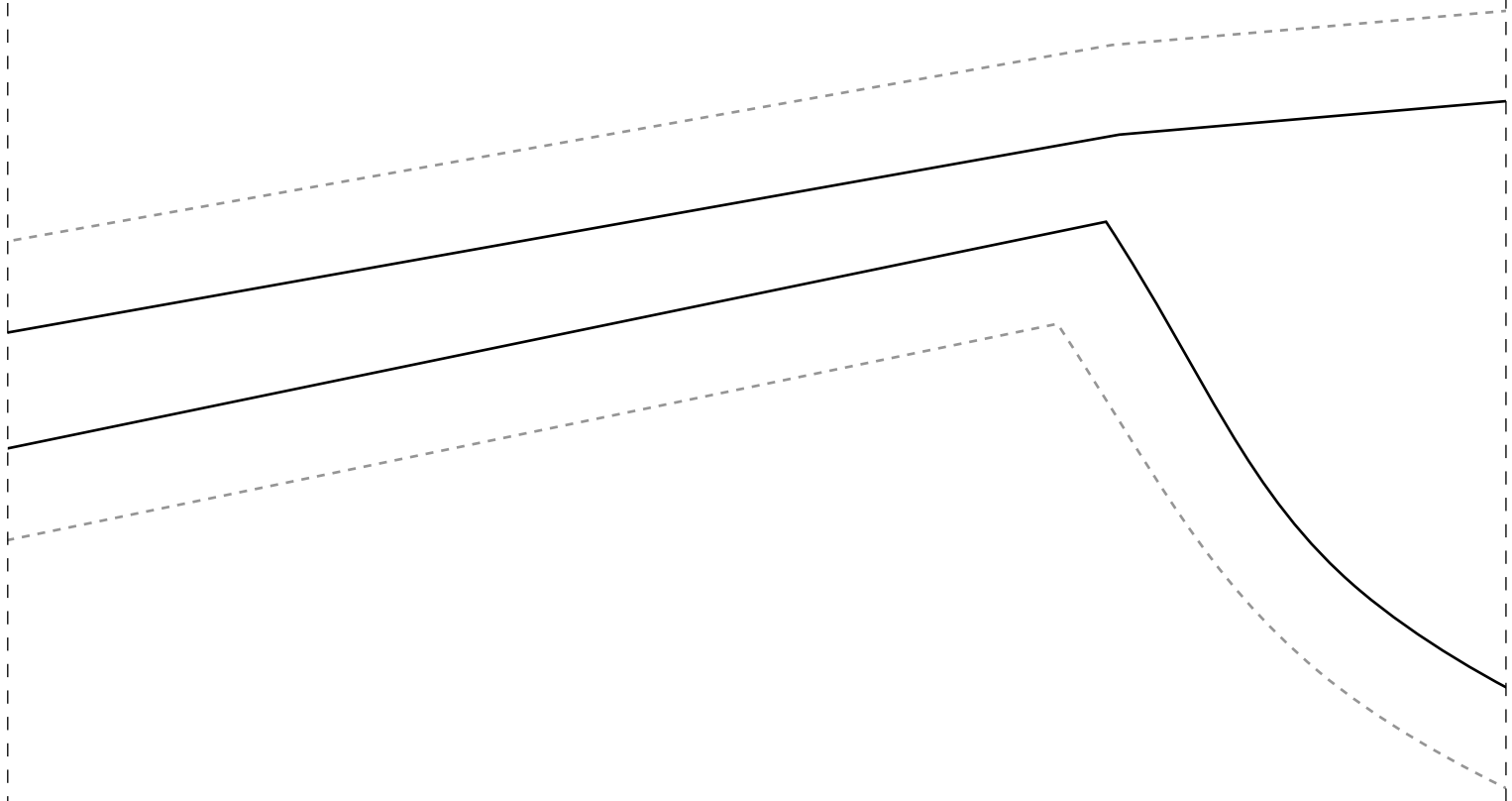

IRA 2X

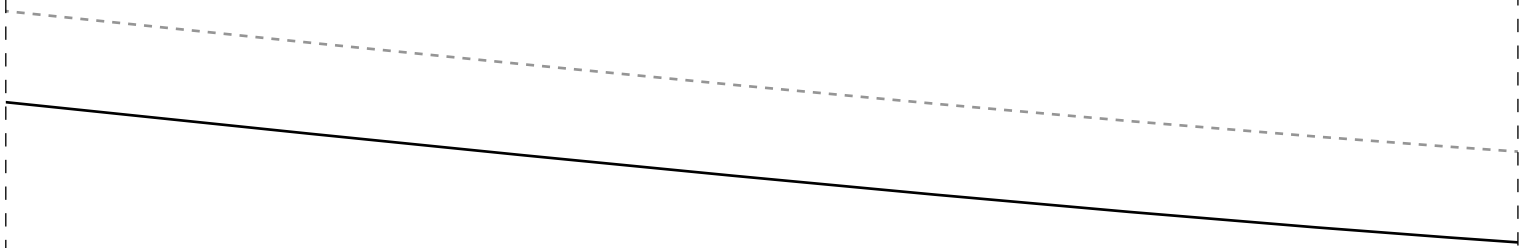

1-5

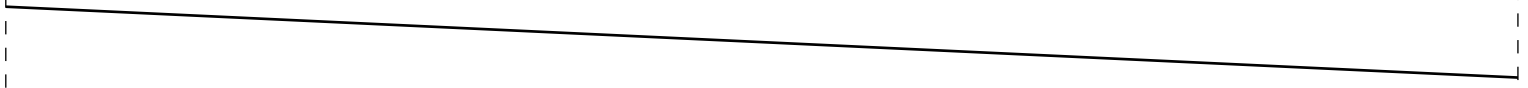

2-5

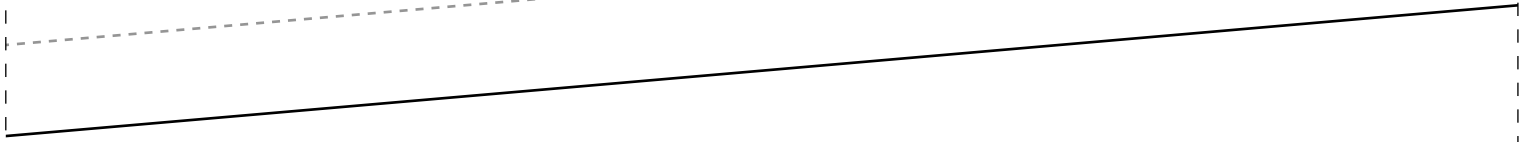







2-6

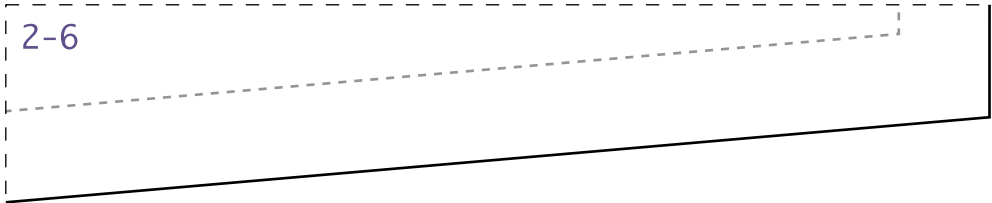

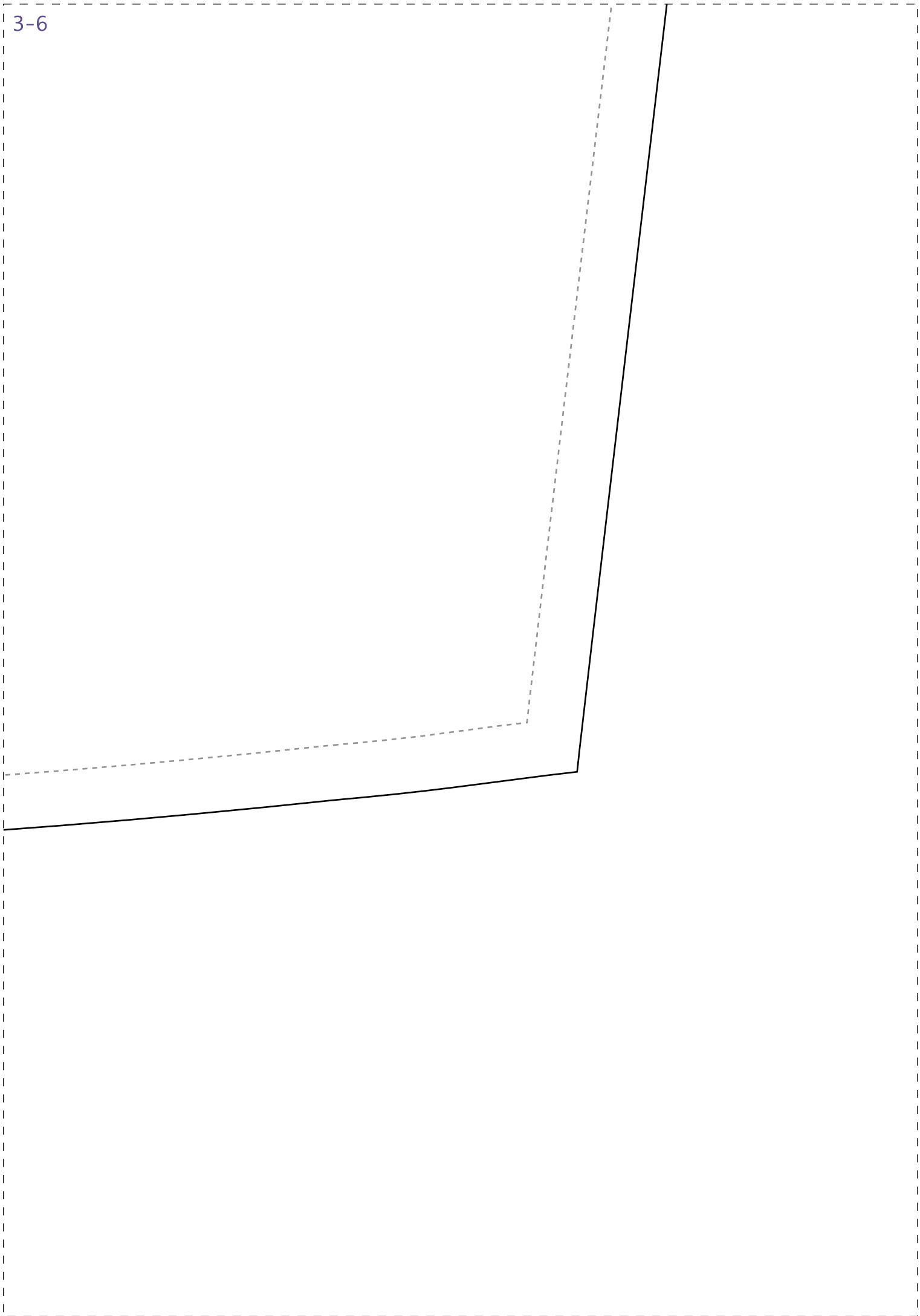

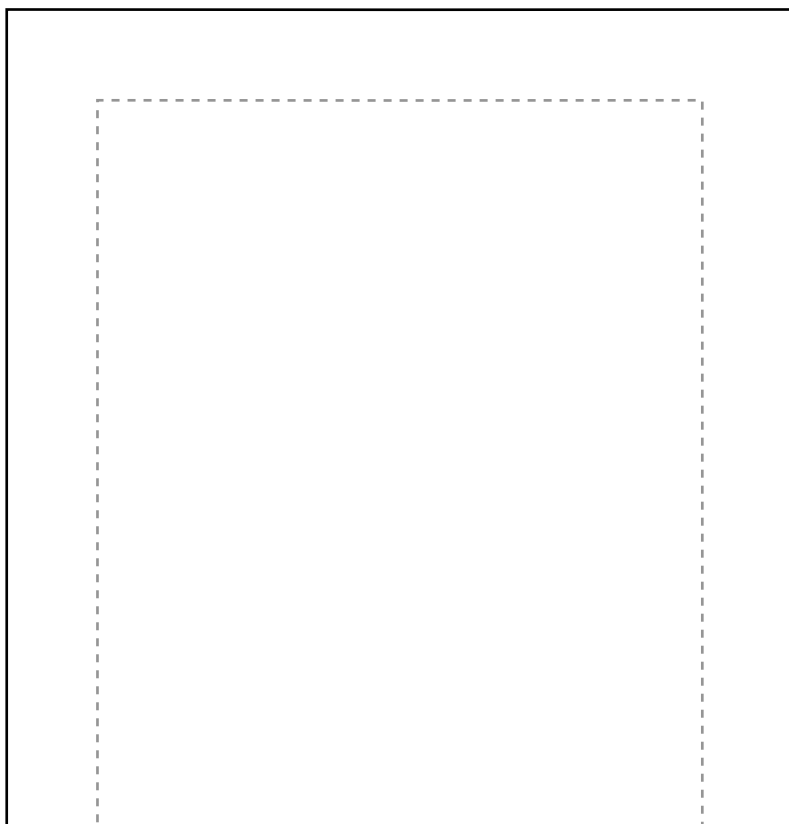

46 - PNH BRR 2X ←

3-7

